

User's Guide

Agilent Technologies E8257D/67D PSG Signal Generators

This guide applies to the following signal generator models:

E8257D PSG Analog Signal Generator

E8267D PSG Vector Signal Generator

Due to our continuing efforts to improve our products through firmware and hardware revisions, signal generator design and operation may vary from descriptions in this guide. We recommend that you use the latest revision of this guide to ensure you have up-to-date product information. Compare the print date of this guide (see bottom of page) with the latest revision, which can be downloaded from the following website:

<http://www.agilent.com/find/psg>



Agilent Technologies

Manufacturing Part Number: E8251-90353

Printed in USA

January 2006

© Copyright 2004-2006 Agilent Technologies, Inc.

Notice

The material in this document is provided “as is,” and is subject to change without notice in future editions.

Further, to the maximum extent permitted by applicable law, Agilent disclaims all warranties, either express or implied with regard to this manual and to any of the Agilent products to which it pertains, including but not limited to the implied warranties of merchantability and fitness for a particular purpose. Agilent shall not be liable for errors or for incidental or consequential damages in connection with the furnishing, use, or performance of this document or any of the Agilent products to which it pertains. Should Agilent have a written contract with the User and should any of the contract terms conflict with these terms, the contract terms shall control.

Questions or Comments about our Documentation?

We welcome any questions or comments you may have about our documentation. Please send us an E-mail at sources_manuals@am.exch.agilent.com.

1. Signal Generator Overview	1
Signal Generator Models and Features	1
E8257D PSG Analog Signal Generator Features	2
E8267D PSG Vector Signal Generator Features	3
Options	4
Firmware Upgrades	4
To Upgrade Firmware	4
Modes of Operation	5
Continuous Wave	5
Swept Signal	5
Analog Modulation	5
Digital Modulation	6
Front Panel	7
1. Display	7
2. Softkeys	8
3. Knob	8
4. Amplitude	8
5. Frequency	8
6. Save	8
7. Recall	8
8. Trigger	8
9. MENUS	9
10. Help	9
11. EXT 1 INPUT	9
12. EXT 2 INPUT	9
13. LF OUTPUT	10
14. Mod On/Off	10
15. ALC INPUT	10
16. RF On/Off	10
17. Numeric Keypad	10
18. RF OUTPUT	10
19. SYNC OUT	10
20. VIDEO OUT	11
21. Incr Set	11
22. GATE/ PULSE/ TRIGGER INPUT	11
23. Arrow Keys	11
24. Hold	11
25. Return	11

Contents

- 26. Contrast Decrease 11
- 27. Contrast Increase. 11
- 28. Local 11
- 29. Preset. 12
- 30. Line Power LED. 12
- 31. LINE. 12
- 32. Standby LED. 12
- 33. SYMBOL SYNC 12
- 34. DATA CLOCK 12
- 35. DATA 12
- 36. Q Input 13
- 37. I Input 13
- Front Panel Display 14
 - 1. Active Entry Area 14
 - 2. Frequency Area. 15
 - 3. Annunciators. 15
 - 4. Digital Modulation Annunciators 17
 - 5. Amplitude Area. 17
 - 6. Error Message Area 17
 - 7. Text Area. 17
 - 8. Softkey Label Area. 17
- Rear Panel. 18
 - 1. EVENT 1 20
 - 2. EVENT 2 20
 - 3. PATTERN TRIG IN 20
 - 4. BURST GATE IN 20
 - 5. BASEBAND GEN REF IN 21
 - 6. DIGITAL BUS 21
 - 7. AUXILIARY I/O 21
 - 8. WIDEBAND I INPUT 22
 - 9. WIDEBAND Q INPUT 23
 - 10. I OUT 23
 - 11. Q OUT. 23
 - 12. I-bar OUT 23
 - 13. Q-bar OUT 24
 - 14. COH CARRIER 24
 - 15. SOURCE MODULE INTERFACE 24
 - 16. AC Power Receptacle 24

17. GPIB	24
18. 10 MHz EFC	24
19. 10 MHz IN	25
20. AUXILIARY INTERFACE	25
21. 10 MHz OUT	25
22. LAN	26
23. STOP SWEEP IN/OUT	26
24. Z-AXIS BLANK/MKRS	26
25. SWEEP OUT	26
26. TRIGGER OUT	26
27. TRIGGER IN	27
28. SOURCE SETTLED	27
29. RF OUT	27
30. EXT 1 Input	27
31. EXT 2 Input	27
32. LF OUT	27
33. PULSE SYNC OUT	27
34. PULSE VIDEO OUT	27
35. PULSE/TRIG GATE INPUT	27
36. ALC INPUT	28
37. DATA	28
38. DATA CLOCK	28
39. SYMBOL SYNC	28
40. I Input	28
41. Q Input	28
2. Basic Operation	29
Using Table Editors	30
Table Editor Softkeys	31
Modifying Table Items in the Data Fields	31
Configuring the RF Output	32
Configuring a Continuous Wave RF Output	32
Configuring a Swept RF Output	34
Extending the Frequency Range	49
Modulating a Signal	49
Turning On a Modulation Format	49
Applying a Modulation Format to the RF Output	50
Using Data Storage Functions	51

Contents

Using the Memory Catalog	51
Using the Instrument State Registers	53
Using Security Functions	55
Understanding PSG Memory Types	56
Removing Sensitive Data from PSG Memory	58
Using the Secure Display	60
Enabling Options	61
Enabling a Software Option	61
Using the Web Server	62
Activating the Web Server	63
3. Basic Digital Operation	67
Custom Modulation	67
Custom Arb Waveform Generator	68
Custom Real Time I/Q Baseband	68
Arbitrary (ARB) Waveform File Headers	68
Creating a File Header for a Modulation Format Waveform	69
Modifying Header Information in a Modulation Format	70
Storing Header Information for a Dual ARB Player Waveform Sequence	75
Modifying and Viewing Header Information in the Dual ARB Player	75
Playing a Waveform File that Contains a Header	78
Using the Dual ARB Waveform Player	79
Accessing the Dual ARB Player	79
Creating Waveform Segments	80
Building and Storing a Waveform Sequence	81
Playing a Waveform	82
Editing a Waveform Sequence	82
Adding Real-Time Noise to a Dual ARB Waveform	82
Storing and Loading Waveform Segments	83
Renaming a Waveform Segment	84
Using Waveform Markers	84
Waveform Marker Concepts	85
Accessing Marker Utilities	88
Viewing Waveform Segment Markers	89
1. Clearing Marker Points from a Waveform Segment	90
2. Setting Marker Points in a Waveform Segment	91
3. Controlling Markers in a Waveform Sequence (Dual ARB Only)	93
Viewing a Marker Pulse	95

Using the RF Blanking Marker Function	96
Setting Marker Polarity	98
Triggering Waveforms	98
Source	99
Mode and Response	99
Accessing Trigger Utilities	100
Setting the Polarity of an External Trigger	101
Using Gated Triggering	101
Using Segment Advance Triggering	103
Using Waveform Clipping	104
How Power Peaks Develop	104
How Peaks Cause Spectral Regrowth	106
How Clipping Reduces Peak-to-Average Power	107
Configuring Circular Clipping	110
Configuring Rectangular Clipping	111
Using Waveform Scaling	112
How DAC Over-Range Errors Occur	112
How Scaling Eliminates DAC Over-Range Errors	113
Scaling a Currently Playing Waveform (Runtime Scaling)	114
Scaling a Waveform File in Volatile Memory	114
4. Optimizing Performance	115
Using the ALC	115
Selecting ALC Bandwidth	115
To Select an ALC Bandwidth	115
Using External Leveling	116
To Level with Detectors and Couplers/Splitters	116
To Level with a mm-Wave Source Module	119
Creating and Applying User Flatness Correction	119
Creating a User Flatness Correction Array	120
Creating a User Flatness Correction Array with a mm-Wave Source Module	124
Adjusting Reference Oscillator Bandwidth (Option UNR/UNX)	130
To Select the Reference Oscillator Bandwidth	130
To Restore Factory Default Settings:	130
5. Analog Modulation	131
Analog Modulation Waveforms	131
Configuring AM (Option UNT)	132

Contents

To Set the Carrier Frequency	132
To Set the RF Output Amplitude	132
To Set the AM Depth and Rate	132
To Turn on Amplitude Modulation	132
Configuring FM (Option UNT)	132
To Set the RF Output Frequency	132
To Set the RF Output Amplitude	132
To Set the FM Deviation and Rate	133
To Activate FM	133
Configuring Φ M (Option UNT)	133
To Set the RF Output Frequency	133
To Set the RF Output Amplitude	133
To Set the FM Deviation and Rate	133
To Activate FM	134
Configuring Pulse Modulation (Option UNU/UNW)	134
To Set the RF Output Frequency	134
To Set the RF Output Amplitude	134
To Set the Pulse Period, Width, and Triggering	134
To Activate Pulse Modulation	134
Configuring the LF Output (Option UNT)	135
To Configure the LF Output with an Internal Modulation Source	135
To Configure the LF Output with a Function Generator Source	136
6. Custom Arb Waveform Generator	137
Overview	137
Working with Predefined Setups (Modes)	137
Selecting a Custom ARB Setup or a Custom Digital Modulation State	138
Working with User-Defined Setups (Modes)-Custom Arb Only	138
Modifying a Single-Carrier NADC Setup	138
Customizing a Multicarrier Setup	139
Recalling a User-Defined Custom Digital Modulation State	140
Working with Filters	140
Using a Predefined FIR Filter	141
Using a User-Defined FIR Filter	142
Working with Symbol Rates	147
To Set a Symbol Rate	147
To Restore the Default Symbol Rate (Custom Real Time I/Q Only)	148
Working with Modulation Types	149

To Select a Predefined Modulation Type	149
To Use a User-Defined Modulation Type (Real Time I/Q Only)	150
Wide Band IQ (Option 015)	155
Configuring Hardware	155
To Set a Delayed, Positive Polarity, External Single Trigger	155
To Set the ARB Reference	157
7. Custom Real Time I/Q Baseband	159
Overview	159
Working with Predefined Setups (Modes)	159
Selecting a Predefined Real Time Modulation Setup	159
Deselecting a Predefined Real Time Modulation Setup	160
Working with Data Patterns	160
Using a Predefined Data Pattern	161
Using a User-Defined Data Pattern	161
Using an Externally Supplied Data Pattern	165
Working with Burst Shapes	165
Configuring the Burst Rise and Fall Parameters	166
Using User-Defined Burst Shape Curves	166
Configuring Hardware	169
To Set the BBG Reference	169
To Set the External DATA CLOCK to Receive Input as Either Normal or Symbol	170
To Set the BBG DATA CLOCK to External or Internal	170
To Adjust the I/Q Scaling	170
Working with Phase Polarity	171
To Set Phase Polarity to Normal or Inverted	171
Working with Differential Data Encoding	171
Understanding Differential Encoding	171
Using Differential Encoding	175
8. Multitone Waveform Generator	179
Overview	179
Creating, Viewing, and Optimizing Multitone Waveforms	180
To Create a Custom Multitone Waveform	180
To View a Multitone Waveform	181
To Edit the Multitone Setup Table	182
To Minimize Carrier Feedthrough	184
To Determine Peak to Average Characteristics	185

Contents

9. Two-Tone Waveform Generator	189
Overview	189
Creating, Viewing, and Modifying Two-Tone Waveforms	189
To Create a Two-Tone Waveform	190
To View a Two-Tone Waveform	191
To Minimize Carrier Feedthrough	192
To Change the Alignment of a Two-Tone Waveform	193
10. AWGN Waveform Generator	195
Configuring the AWGN Generator	195
Arb Waveform Generator AWGN	195
Real Time I/Q Baseband AWGN	196
11. Peripheral Devices	197
N5102A Digital Signal Interface Module	197
Clock Timing	197
Connecting the Clock Source and the Device Under Test	210
Data Types	212
Operating the N5102A Module in Output Mode	213
Operating the N5102A Module in Input Mode	222
Millimeter-Wave Source Modules	230
Using Agilent Millimeter-Wave Source Modules	230
Using Other Source Modules	234
12. Troubleshooting	237
RF Output Power Problems	237
No RF Output Power when Playing a Waveform File	237
RF Output Power too Low	238
The Power Supply has Shut Down	238
Signal Loss While Working with a Mixer	238
Signal Loss While Working with a Spectrum Analyzer	240
No Modulation at the RF Output	241
Sweep Problems	242
Sweep Appears to be Stalled	242
Cannot Turn Off Sweep Mode	242
Incorrect List Sweep Dwell Time	242
List Sweep Information is Missing from a Recalled Register	243
Data Storage Problems	243

Registers With Previously Stored Instrument States are Empty	243
Saved Instrument State, but Register is Empty or Contains Wrong State.	243
Cannot Turn Off Help Mode.	244
Signal Generator Locks Up.	244
Fail-Safe Recovery Sequence	244
Error Messages	245
Error Message File	246
Error Message Format.	246
Error Message Types.	246
Contacting Agilent Sales and Service Offices	247
Returning a Signal Generator to Agilent Technologies	247

Contents

1 Signal Generator Overview

In the following sections, this chapter describes the models, options, and features available for Agilent E8257D/67D PSG signal generators. The modes of operation, front panel user interface, as well as front and rear panel connectors are also described.

- “Signal Generator Models and Features” on page 1
- “Options” on page 4
- “Firmware Upgrades” on page 4
- “Modes of Operation” on page 5
- “Front Panel” on page 7
- “Front Panel Display” on page 14
- “Rear Panel” on page 18

NOTE For more information about the PSG, such as data sheets, configuration guides, application notes, frequently asked questions, technical support, software and more, visit the Agilent PSG web page at <http://www.agilent.com/find/psg>.

Signal Generator Models and Features

Table 1-1 lists the available PSG signal generator models and frequency-range options.

Table 1-1 PSG Signal Generator Models

Model	Frequency Range Options
E8257D PSG analog signal generator	250 kHz to 20 GHz (Option 520) 250 kHz to 31.8 GHz (Option 532) 250 kHz to 40 GHz (Option 540) 250 kHz to 50 GHz (Option 550) 250 kHz to 67 GHz ^a (Option 567)
E8267D PSG vector signal generator	250 kHz to 20 GHz (Option 520) 250 kHz to 31.8 GHz (Option 532) 250 kHz to 44 GHz (Option 544)

a. functional, but unspecified, above 67 GHz to 70 GHz

E8257D PSG Analog Signal Generator Features

The E8257D PSG includes the following standard features:

- CW output from 250 kHz to the highest operating frequency, depending on the option
- frequency resolution to 0.001 Hz
- list and step sweep of frequency and amplitude, with multiple trigger sources
- user flatness correction
- external diode detector leveling
- automatic leveling control (ALC) on and off modes; power calibration in ALC-off mode is available, even without power search
- 10 MHz reference oscillator with external output
- RS-232, GPIB, and 10Base-T LAN I/O interfaces
- a source module interface that is compatible with Agilent 83550 Series millimeter-wave source modules for frequency extension up to 110 GHz and Oleson Microwave Labs (OML) AG-Series millimeter-wave modules for frequency extensions up to 325 GHz

The E8257D PSG also offers the following optional features:

Option 007—analog ramp sweep

Option UNR/UNX—enhanced phase noise performance

Option UNT—AM, FM, phase modulation, and LF output

- open-loop or closed-loop AM
- dc-synthesized FM to 10 MHz rates; maximum deviation depends on the carrier frequency
- external modulation inputs for AM, FM, and Φ M
- simultaneous modulation configurations (except: FM with Φ M or Linear AM with Exponential AM)
- dual function generators that include the following:
 - 50-ohm low-frequency output, 0 to 3 Vp, available through the LF output
 - selectable waveforms: sine, dual-sine, swept-sine, triangle, positive ramp, negative ramp, square, uniform noise, Gaussian noise, and dc
 - adjustable frequency modulation rates
 - selectable triggering in list and step sweep modes: free run (auto), trigger key (single), bus (remote), and external

Option UNU—pulse modulation

- internal pulse generator
- external modulation inputs
- selectable pulse modes: internal square, internal free-run, internal triggered, internal doublet, internal gated, and external pulse; internal triggered, internal doublet, and internal gated

require an external trigger source

- adjustable pulse rate
- adjustable pulse period
- adjustable pulse width (150 ns minimum)
- adjustable pulse delay
- selectable external pulse triggering: positive or negative

Option UNW—narrow pulse modulation

- generate narrow pulses (20 ns minimum) across the operational frequency band of the PSG
- includes all the same functionality as Option UNU

Option IEA—high output power

Option IE1—step attenuator

Option IED—Type-N female RF output connector

Option IEH—improved harmonics below 2 GHz

Option IEM—moves all front panel connectors to the rear panel

E8267D PSG Vector Signal Generator Features

The E8267D PSG provides the same standard functionality of the E8257D PSG, and adds the following standard features:

- internal I/Q modulator
- external analog I/Q inputs
- single-ended and differential analog I/Q outputs
- high output power (optional for the E8257D)
- step attenuator (optional for the E8257D)

The E8267D PSG offers the same optional functionality of the E8257D PSG, and adds the following optional features:

Option 601—internal baseband generator with 8 megasamples of memory

Option 602—internal baseband generator with 64 megasamples of memory

Option 003—PSG digital output connectivity with N5102A

Option 004—PSG digital input connectivity with N5102A

Option 005—6 GB internal hard drive

Option 015—wideband external I/Q inputs

Options

PSG signal generators have hardware, firmware, software, and documentation options. The *Data Sheet* shipped with your signal generator provides an overview of available options. For more information, visit the Agilent PSG web page at <http://www.agilent.com/find/psg>, where you can select the desired PSG model and then click **View price list**. The price list provides you with a current list of available options for the selected model.

Firmware Upgrades

You can upgrade the firmware in your signal generator whenever new firmware is released. New firmware releases, which can be downloaded from the Agilent website, may contain signal generator features and functionality not available in previous firmware releases.

To inquire about the availability of new signal generator firmware, visit the Agilent Firmware Upgrade Assistant web page at <http://www.agilent.com/find/upgradeassistant>, or call the number listed at <http://www.agilent.com/find/assist>.

To Upgrade Firmware

The following procedure shows you how to download new firmware to your PSG using a LAN connection and a PC. For information on equipment requirements and alternate methods of downloading firmware, such as GPIB, refer to the *PSG/ESG Firmware Upgrade Guide*, which can be accessed at <http://www.agilent.com/find/upgradeassistant>.

1. Note the IP address of your signal generator. To view the IP address on the PSG, press **Utility > GPIB/RS-232 LAN > LAN Setup**.
2. Use an internet browser to visit <http://www.agilent.com/find/upgradeassistant>.
3. Scroll down to “Documents and Downloads” and click **E82x7D PSG, NEW Firmware C.xx.xx**. This opens another web page where you must make the same selection.
4. Scroll down to “Documents and Downloads” and click **E82x7D PSG, NEW Firmware C.xx.xx**.
5. In the File Download window, select **Run this program from its current location** and click **OK**.
6. In the Security Warning window, click **Yes** and follow the on-screen instructions. The firmware files download to the PC. When you click **Finish**, the browser displays the **NEW Firmware** page.
7. In the browser, click the **Back** button to return to the **Firmware Upgrade Assistant** page.
8. In the “Documents and Downloads” table, click **PSG/ESG Upgrade Assistant x.xx**, and download the **Upgrade Assistant**.
9. At the desktop shortcut prompt, click **Yes**.
10. Once the utility downloads, close the browser and double-click the **PSG/ESG Upgrade Assistant** icon on the desktop.

11. In the Upgrade Assistant, set the connection type you wish to use to download the firmware, and the parameters for the type of connection selected. For LAN, enter the instrument's IP address, which you recorded in [step 1](#).

NOTE If the PSG's dynamic host configuration protocol (DHCP) is enabled, the network assigns the instrument an IP address at power on. Because of this, when DHCP is enabled the IP address may be different each time you turn on the instrument. DHCP does *not* affect the hostname.

12. Click **Browse**, and double-click the firmware revision to upgrade your signal generator.
13. In the Upgrade Assistant, click **Next**.
14. Once connection to the instrument is verified, click **Next** and follow the on-screen prompts.

NOTE Once the download starts, it cannot be aborted.

NOTE When the User Attention message appears, you must *first* cycle the instrument's power, *then* click OK.

When the upgrade completes, the Upgrade Assistant displays a summary.

15. Click **OK** and close the Upgrade Assistant.

Modes of Operation

Depending on the model and installed options, the PSG signal generator provides up to four basic modes of operation: continuous wave (CW), swept signal, analog modulation, and digital modulation.

Continuous Wave

In this mode, the signal generator produces a continuous wave signal. The signal generator is set to a single frequency and power level. Both the E8257D and E8267D can produce a CW signal.

Swept Signal

In this mode, the signal generator sweeps over a range of frequencies and/or power levels. Both the E8257D and E8267D provide list and step sweep functionality. Option 007 adds analog ramp sweep functionality.

Analog Modulation

In this mode, the signal generator modulates a CW signal with an analog signal. The analog modulation types available depend on the installed options.

Option UNT provides AM, FM, and Φ M modulations. Some of these modulations can be used together. Options UNU and UNW provide standard and narrow pulse modulation capability, respectively.

Digital Modulation

In this mode, the signal generator modulates a CW signal with either a real-time I/Q signal or arbitrary I/Q waveform. I/Q modulation is only available on the E8267D. An internal baseband generator (Option 601/602) adds the following digital modulation formats:

- *Custom Arb Waveform Generator* mode can produce a single-modulated carrier or multiple-modulated carriers. Each modulated carrier waveform must be calculated and generated before it can be output; this signal generation occurs on the internal baseband generator. Once a waveform has been created, it can be stored and recalled, which enables repeatable playback of test signals. To learn more, refer to [“Custom Arb Waveform Generator” on page 137](#).
- *Custom Real Time I/Q Baseband* mode produces a single carrier, but it can be modulated with real-time data that allows real-time control over all of the parameters that affect the signal. The single-carrier signal that is produced can be modified by applying various data patterns, filters, symbol rates, modulation types, and burst shapes. To learn more, refer to [“Custom Real Time I/Q Baseband” on page 159](#).
- *Two Tone* mode produces two separate continuous wave signals (or tones). The frequency spacing between the two signals the amplitudes are adjustable. To learn more, refer to [“Two-Tone Waveform Generator” on page 189](#).
- *Multitone* mode produces up to 64 continuous wave signals (or tones). Like Two Tone mode, the frequency spacing between the signals and the amplitudes are adjustable. To learn more, refer to [“Multitone Waveform Generator” on page 179](#).
- *Dual ARB* mode is used to control the playback sequence of waveform segments that have been written into the ARB memory located on the internal baseband generator. These waveforms can be generated by the internal baseband generator using the Custom Arb Waveform Generator mode, or downloaded through a remote interface into the ARB memory. To learn more, refer to [“Using the Dual ARB Waveform Player” on page 79](#).

Front Panel

This section describes each item on the PSG front panel. [Figure 1-1](#) shows an E8267D front panel, which includes all items available on the E8257D as well.

Figure 1-1 Front Panel Diagram (E8267D PSG Vector Signal Generator)

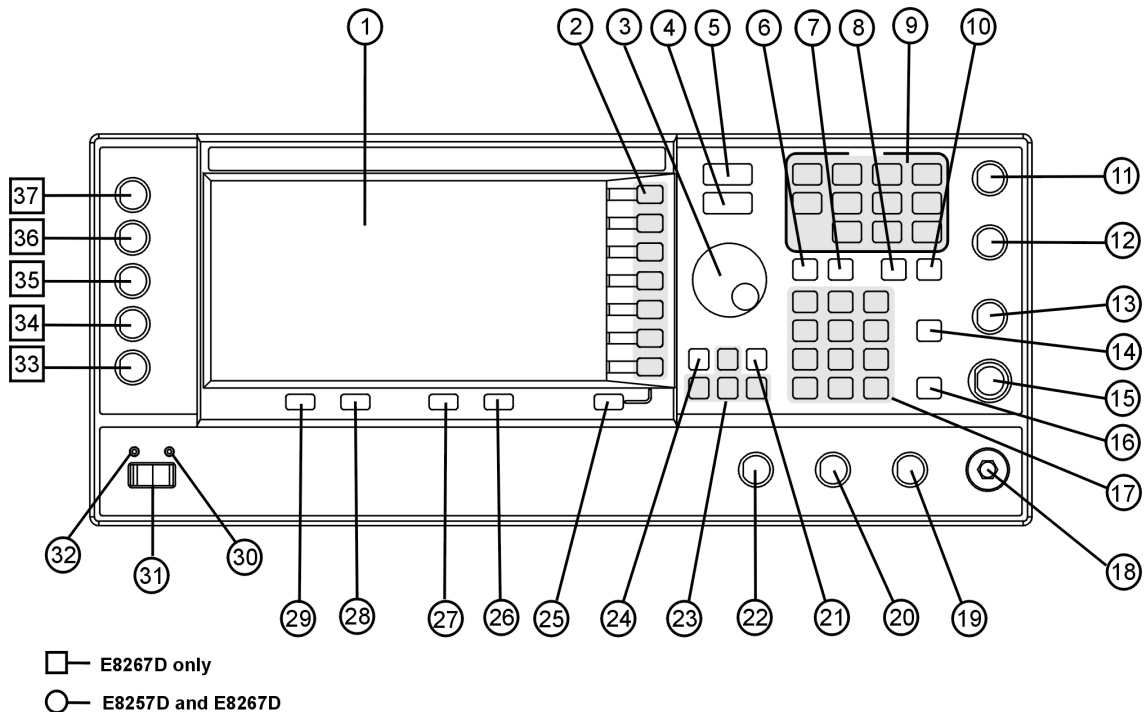

- | | | | |
|--------------|--------------------|--------------------------------|--------------------|
| 1. Display | 10. Help | 19. SYNC OUT | 28. Local |
| 2. Softkeys | 11. EXT 1 INPUT | 20. VIDEO OUT | 29. Preset |
| 3. Knob | 12. EXT 2 INPUT | 21. Incr Set | 30. Line Power LED |
| 4. Amplitude | 13. LF OUTPUT | 22. GATE/ PULSE/ TRIGGER INPUT | 31. LINE |
| 5. Frequency | 14. Mod On/Off | 23. Arrow Keys | 32. Standby LED |
| 6. Save | 15. ALC INPUT | 24. Hold | 33. SYMBOL SYNC |
| 7. Recall | 16. RF On/Off | 25. Return | 34. DATA CLOCK |
| 8. Trigger | 17. Numeric Keypad | 26. Contrast Decrease | 35. DATA |
| 9. MENUS | 18. RF OUTPUT | 27. Contrast Increase | 36. Q Input |
| | | | 37. I Input |

1. Display

The LCD screen provides information on the current function. Information can include status indicators, frequency and amplitude settings, and error messages. Softkeys labels are located on the right-hand side of the display. For more detail on the front panel display, see [“Front Panel Display”](#)

on page 14.

2. Softkeys

Softkeys activate the displayed function to the left of each key.

3. Knob

Use the knob to increase or decrease a numeric value, change a highlighted digit or character, or step through lists or select items in a row.

4. Amplitude

Pressing this hardkey makes amplitude the active function. You can change the output amplitude or use the menus to configure amplitude attributes such as power search, user flatness, and leveling mode.

5. Frequency

Pressing this hardkey makes frequency the active function. You can change the output frequency or use the menus to configure frequency attributes such as frequency multiplier, offset, and reference.

6. Save

Pressing this hardkey accesses a menu of choices that enable you to save data in the instrument state register. The instrument state register is a section of memory divided into 10 sequences (numbered 0 through 9), each containing 100 registers (numbered 00 through 99). It is used to store and recall frequency, amplitude, and modulation settings.

The Save hardkey provides a quick alternative to reconfiguring the signal generator through the front panel or SCPI commands when switching between different signal configurations. Once an instrument state has been saved, all of the frequency, amplitude, and modulation settings can be recalled with the Recall hardkey. For more information on saving and recalling instrument states, refer to [“Using the Instrument State Registers” on page 53](#).

7. Recall

Restores an instrument state saved in a memory register. To recall an instrument state, press Recall and enter the desired sequence number and register number. To save a state, use the Save hardkey. For more information on saving and recalling instrument states, refer to [“Using the Instrument State Registers” on page 53](#).

8. Trigger

Initiates an immediate trigger event for a function such as a list, step, or ramp sweep (Option 007 only). Before this hardkey can be used to initiate a trigger event, the trigger mode must be set to Trigger Key. For example: press the Sweep/List hardkey, then one of the following sequences of softkeys:

- More (1 of 2) > Sweep Trigger > Trigger Key
- More (1 of 2) > Point Trigger > Trigger Key

9. MENUS

These keys open softkey menus for configuring various functions. For descriptions, see the *E8257D/67D PSG Signal Generators Key Reference*.

Table 1-2 Hardkeys in Front Panel MENUS Group

E8257D PSG Analog	E8267D PSG Vector	
AM Sweep/List FM/ Φ M Utility Pulse LF Out	Mode Mux AM Sweep/List Mode Setup Aux Fctn	FM/ Φ M Utility I/Q Pulse LF Out

NOTE Some menus are optional. Refer to [“Options” on page 4](#) for more information.

10. Help

Pressing this hardkey accesses a short description of any hardkey or softkey and, in most cases, a listing of related remote-operation SCPI commands. There are two help modes available on the signal generator: single and continuous. The single mode is the factory preset condition. Toggle between single and continuous mode by pressing Utility > Instrument Info/Help Mode > Help Mode Single Cont.

- In single mode, help text is provided for the next key you press without activating the key's function. Any key pressed afterward exits the help mode and its function is activated.
- In continuous mode, help text is provided for each subsequent key press until you press the **Help** hardkey again or change to single mode. In addition, each key is active, meaning that the key function is executed (except for the Preset key).

11. EXT 1 INPUT

This female BNC input connector (functional only with Options UNT, UNU, or UNW) accepts a $\pm 1 V_p$ signal for AM, FM, and Φ M. For these modulations, $\pm 1 V_p$ produces the indicated deviation or depth. When ac-coupled inputs are selected for AM, FM, or Φ M and the peak input voltage differs from $1 V_p$ by more than 3 percent, the HI/LO display annunciators light. The input impedance is selectable as either 50 or 600 ohms; the damage levels are $5 V_{rms}$ and $10 V_p$. On signal generators with Option 1EM, this connector is relocated to the rear panel.

12. EXT 2 INPUT

This female BNC input connector (functional only with Options UNT, UNU, or UNW) accepts a $\pm 1 V_p$ signal for AM, FM, and Φ M. With AM, FM, or Φ M, $\pm 1 V_p$ produces the indicated deviation or depth. When ac-coupled inputs are selected for AM, FM, or Φ M and the peak input voltage differs from $1 V_p$ by more than 3 percent, the HI/LO annunciators light on the display. The input impedance is selectable as either 50 or 600 ohms and damage levels are $5 V_{rms}$ and $10 V_p$. On signal generators with Option 1EM, this input is relocated to the rear panel.

13. LF OUTPUT

This female BNC output connector (functional only with Option UNT) outputs modulation signals generated by the low frequency (LF) source function generator. This output is capable of driving $3V_p$ (nominal) into a 50-ohm load. On signal generators with Option 1EM, this output is relocated to the rear panel.

14. Mod On/Off

This hardkey (E8257D with Options UNT, UNU, or UNW and E8267D only) enables or disables all active modulation formats (AM, FM, Φ M, Pulse, or I/Q) applied to the output carrier signal available through the RF Output connector. This hardkey does not set up or activate an AM, FM, Φ M, Pulse, or I/Q format; each modulation format must still be set up and activated (for example, AM > AM On) or nothing is applied to the output carrier signal when the Mod On/Off hardkey is enabled. The MOD ON/OFF annunciator indicates whether active modulation formats have been enabled or disabled with the Mod On/Off hardkey.

15. ALC INPUT

This female BNC input connector is used for negative external detector leveling. This connector accepts an input of -0.2 mV to -0.5 V. The nominal input impedance is 120 kohms and the damage level is ± 15 V. On signal generators with Option 1EM, this input is relocated to the rear panel.

16. RF On/Off

Pressing this hardkey toggles the operating state of the RF signal present at the RF OUTPUT connector. Although you can set up and enable various frequency, power, and modulation states, the RF and microwave output signal is not present at the RF OUTPUT until RF On/Off is set to On. The RF On/Off annunciator is always visible in the display to indicate whether the RF is turned on or off.

17. Numeric Keypad

The numeric keypad consists of the 0 through 9 hardkeys, a decimal point hardkey, and a backspace hardkey (). The backspace hardkey enables you to backspace or alternate between a positive and a negative value. When specifying a negative numeric value, the negative sign must be entered prior to entering the numeric value.

18. RF OUTPUT

This connector outputs RF and microwave signals. The nominal output impedance is 50 ohms. The reverse-power damage levels are 0 Vdc, 0.5 watts nominal. On signal generators with Option 1EM, this output is relocated on the rear panel. The connector type varies according to frequency option.

19. SYNC OUT

This female BNC output connector (functional only with Options UNU or UNW) outputs a synchronizing TTL-compatible pulse signal that is nominally 50 ns wide during internal and triggered pulse modulation. The nominal source impedance is 50 ohms. On signal generators with Option 1EM, this output is relocated to the rear panel.

20. VIDEO OUT

This female BNC output connector (functional only with Options UNU or UNW) outputs a TTL-level compatible pulse signal that follows the output envelope in all pulse modes. The nominal source impedance is 50 ohms. On signal generators with Option 1EM, this output is relocated to the rear panel.

21. Incr Set

This hardkey enables you to set the increment value of the current active function. The increment value of the current active function appears in the active entry area of the display. Use the numeric keypad, arrow hardkeys, or the knob to adjust the increment value.

22. GATE/ PULSE/ TRIGGER INPUT

This female BNC input connector (functional only with Options UNU or UNW) accepts an externally supplied pulse signal for use as a pulse or trigger input. With pulse modulation, +1 V is on and 0 V is off (trigger threshold of 0.5 V with a hysteresis of 10 percent; so 0.6 V would be on and 0.4 V would be off). The damage levels are $\pm 5 V_{\text{rms}}$ and 10 V_p. The nominal input impedance is 50 ohms. On signal generators with Option 1EM, this input is relocated to the rear panel.

23. Arrow Keys

These up and down arrow hardkeys are used to increase or decrease a numeric value, step through displayed lists, or to select items in a row of a displayed list. Individual digits or characters may be highlighted using the left and right arrow hardkeys. Once an individual digit or character is highlighted, its value can be changed using the up and down arrow hardkeys.

24. Hold

Pressing this hardkey blanks the softkey label area and text areas on the display. Softkeys, arrow hardkeys, the knob, the numeric keypad, and the IncrSet hardkey have no effect once this hardkey is pressed.

25. Return

Pressing this hardkey returns you to the softkey menu you were at previously. It enables you to step back through the menus until you reach the first menu you selected.

26. Contrast Decrease

Pressing this hardkey causes the display background to darken.

27. Contrast Increase

Pressing this hardkey causes the display background to lighten.

28. Local

Pressing this hardkey deactivates remote operation and returns the signal generator to front-panel

control.

29. Preset

Pressing this hardkey sets the signal generator to a known state (factory or user-defined).

30. Line Power LED

This green LED indicates when the signal generator power switch is set to the on position.

31. LINE

In the on position, this switch activates full power to the signal generator; in standby, it deactivates all signal generator functions. In standby, the signal generator remains connected to the line power and power is supplied to some internal circuits.

32. Standby LED

This yellow LED indicates when the signal generator power switch is set to the standby condition.

33. SYMBOL SYNC

This female BNC input connector (E8267D only) is CMOS-compatible and accepts an externally supplied symbol sync signal for use with the internal baseband generator (Option 601/602). The expected input is a 3.3 V CMOS bit clock signal (which is also TTL compatible). SYMBOL SYNC might occur once per symbol or be a single one-bit-wide pulse that is used to synchronize the first bit of the first symbol. The maximum clock rate is 50 MHz. The damage levels are $> +5.5$ V and < -0.5 V. The nominal input impedance is not definable. SYMBOL SYNC can be used in two modes:

- When used as a symbol sync in conjunction with a data clock, the signal must be high during the first data bit of the symbol. The signal must be valid during the falling edge of the data clock signal and may be a single pulse or continuous.
- When the SYMBOL SYNC itself is used as the (symbol) clock, the CMOS falling edge is used to clock the DATA signal.

On signal generators with Option 1EM, this input is relocated to the rear panel.

34. DATA CLOCK

This female BNC input connector (E8267D only) is CMOS compatible and accepts an externally supplied data-clock input signal to synchronize serial data for use with the internal baseband generator (Option 601/602). The expected input is a 3.3 V CMOS bit clock signal (which is also TTL compatible) where the rising edge is aligned with the beginning data bit. The falling edge is used to clock the DATA and SYMBOL SYNC signals. The maximum clock rate is 50 MHz. The damage levels are $> +5.5$ V and < -0.5 V. The nominal input impedance is not definable. On signal generators with Option 1EM, this input is relocated to the rear panel.

35. DATA

This female BNC input connector (E8267D with Option 601/602 only) is CMOS compatible and

accepts an externally supplied serial data input for digital modulation applications. The expected input is a 3.3 V CMOS signal (which is also TTL compatible) where a CMOS high = a data 1 and a CMOS low = a data 0. The maximum input data rate is 50 Mb/s. The data must be valid on the falling edges of the data clock (normal mode) or the on the falling edges of the symbol sync (symbol mode). The damage levels are $> +5.5$ and $< -0.5V$. The nominal input impedance is not definable. On signal generators with Option 1EM, this input is relocated to the rear panel.

36. Q Input

This female BNC input connector (E8267D only) accepts the quadrature-phase (Q) component an externally supplied, analog, I/Q modulation. The in-phase (I) component is supplied through the I INPUT. The signal level is $\sqrt{I^2+Q^2} = 0.5 V_{\text{rms}}$ for a calibrated output level. The nominal input impedance is 50 or 600 ohms. The damage level is $1 V_{\text{rms}}$ and $10 V_{\text{peak}}$. To activate signals applied to the I and Q input connectors, press **Mux** > **I/Q Source 1** or **I/Q Source 2** and then select either **Ext 50 Ohm** or **Ext 600 Ohm**. On signal generators with Option 1EM, these inputs are relocated to the rear panel.

37. I Input

This female BNC input connector (E8267D only) accepts the in-phase (I) component an externally supplied, analog, I/Q modulation. The quadrature-phase (Q) component is supplied through the Q INPUT. The signal level is $\sqrt{I^2+Q^2} = 0.5 V_{\text{rms}}$ for a calibrated output level. The nominal input impedance is 50 or 600 ohms. The damage level is $1 V_{\text{rms}}$ and $10 V_{\text{peak}}$. To activate signals applied to the I and Q input connectors, press **Mux** > **I/Q Source 1** or **I/Q Source 2** and then select either **Ext 50 Ohm** or **Ext 600 Ohm**. On signal generators with Option 1EM, these inputs are relocated to the rear panel.

Front Panel Display

Figure 1-2 shows the various regions of the PSG display. This section describes each region.

Figure 1-2 Front Panel Display Diagram

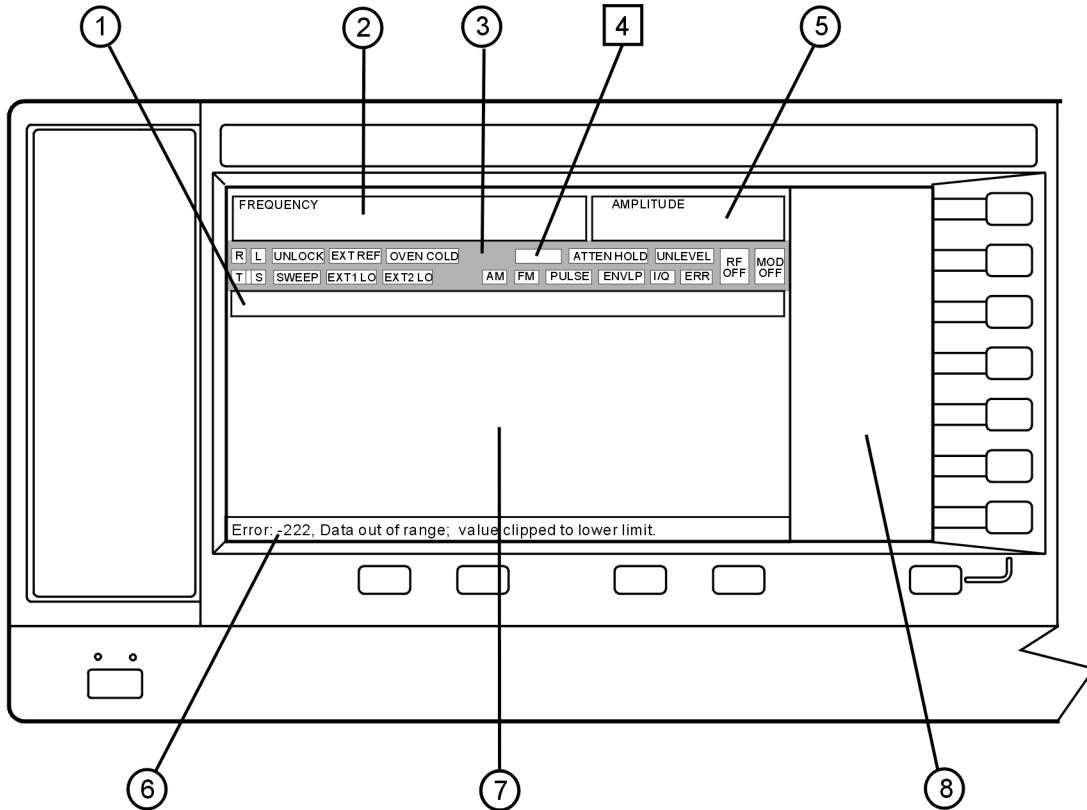

- E8267D only
- E8257D and E8267D

- 1. Active Entry Area
- 2. Frequency Area
- 3. Annunciators
- 4. Digital Modulation Annunciators
- 5. Amplitude Area
- 6. Error Message Area
- 7. Text Area
- 8. Softkey Label Area

1. Active Entry Area

The current active function is shown in this area. For example, if frequency is the active function, the current frequency setting will be displayed here. If the current active function has an increment value

associated with it, that value is also displayed.

2. Frequency Area

The current frequency setting is shown in this portion of the display. Indicators are also displayed in this area when the frequency offset or multiplier is used, the frequency reference mode is turned on, or a source module is enabled.

3. Annunciators

The display annunciators show the status of some of the signal generator functions and indicate any error conditions. An annunciator position may be used by more than one function. This does not create a problem, because only one function that shares an annunciator position can be active at a time.

ΦM	This annunciator (Option UNT only) appears when phase modulation is on. If frequency modulation is on, the FM annunciator replaces ΦM.
ALC OFF	This annunciator appears when the ALC circuit is disabled. A second annunciator, UNLEVEL, appears in the same position if the ALC is enabled and cannot maintain the output level.
AM	This annunciator (Option UNT only) appears when amplitude modulation is on.
ARMED	This annunciator appears when a sweep has been initiated and the signal generator is waiting for the sweep trigger event.
ATTEN HOLD	This annunciator (Option 1E1 or E8267D only) appears when the attenuator hold function is on. When this function is on, the attenuator is held at its current setting.
DIG BUS	This annunciator (Options 003 or 004 only) appears when the Digital Bus is active, and the internal oven reference oscillator is not cold (OVEN COLD appears in this same location).
ENVLP	This annunciator appears if a burst condition exists, such as when marker 2 is set to enable RF blanking in the Dual ARB format.
ERR	This annunciator appears when an error message is in the error queue. This annunciator does not turn off until you either view all the error messages or cleared the error queue. To access error messages, press Utility > Error Info .
EXT	This annunciator appears when external leveling is on.
EXT1 LO/HI	This annunciator (Options UNT, UNU, or UNW only) appears as either EXT1 LO or EXT1 HI, when the ac-coupled signal to the EXT 1 INPUT is $<0.97 V_p$ or $>1.03 V_p$.
EXT2 LO/HI	This annunciator (Options UNT, UNU, or UNW only) is displayed as either EXT2 LO or EXT2 HI. This annunciator appears when the ac-coupled signal to the EXT 2 INPUT is $<0.97 V_p$ or $>1.03 V_p$.
EXT REF	This annunciator appears when an external frequency reference is applied.
FM	This annunciator (Option UNT only) appears when frequency modulation is turned on. If phase modulation is turned on, the ΦM annunciator will replace FM.
I/Q	This annunciator (E8267D only) appears when I/Q modulation is turned on.

L	This annunciator appears when the signal generator is in listener mode and is receiving information or commands over the RS-232, GPIB, or VXI-11 LAN interface.
MOD ON/OFF	This annunciator (E8257D with Options UNT, UNU, or UNW and E8267D only) indicates whether active modulation formats have been enabled or disabled. Pressing the Mod On/Off hardkey enables or disables all active modulation formats (AM, FM, Φ M, Pulse, or I/Q) that are applied to the output carrier signal available through the RF Output connector. The Mod On/Off hardkey does not set up or activate an AM, FM, Φ M, Pulse, or I/Q format; each individual modulation format must still be set up and activated (for example, AM > AM On) or nothing will be applied to the output carrier signal when the Mod On/Off hardkey is enabled.
OVEN COLD	This annunciator (Option UNR/UNX only) appears when the temperature of the internal oven reference oscillator has dropped below an acceptable level. When this annunciator is on, frequency accuracy is degraded. This condition should occur for several minutes after the signal generator is first connected to line power.
PULSE	This annunciator (Options UNU or UNW only) appears when pulse modulation is on.
R	This annunciator appears when the signal generator is remotely controlled over the GPIB, RS-232, or VXI-11/Sockets LAN interface (TELNET operation does not activate the R annunciator). When the R annunciator is on, the front panel keys are disabled, except for the Local key and the line power switch. For information on remote operation, refer to the <i>E8257D/67D PSG Signal Generators Programming Guide</i> .
RF ON/OFF	This annunciator indicates when the RF and microwave signal is present (RF ON) at the RF OUTPUT, or if the RF and microwave signal is not present (RF OFF) at the RF OUTPUT. Either condition of this annunciator is always visible in the display.
S	This annunciator appears when the signal generator has generated a service request (SRQ) over the RS-232, GPIB, or VXI-11 LAN interface.
SWEEP	This annunciator appears when the signal generator is in list, step, or ramp sweep mode (ramp sweep is available with Option 007 only). List mode is when the signal generator can jump from point to point in a list (hop list); the list is traversed in ascending or descending order. The list can be a frequency list, a power level list, or both. Step mode is when a start, stop, and step value (frequency or power level) are defined and the signal generator produces signals that start at the start value and increment by the step value until it reaches the stop value. Ramp sweep mode (Option 007 only) is when a start and stop value (frequency or power level) are defined and the signal generator produces signals that start at the start value and produce a continuous output until it reaches the stop value.
T	This annunciator appears when the signal generator is in talker mode and is transmitting information over the GPIB, RS-232, or VXI-11 LAN interface.

UNLEVEL	This annunciator appears when the signal generator is unable to maintain the correct output level. The UNLEVEL annunciator is not necessarily an indication of instrument failure. Unleveled conditions can occur during normal operation. A second annunciator, ALC OFF, will appear in the same position when the ALC circuit is disabled.
UNLOCK	This annunciator appears when any of the phase locked loops are unable to maintain phase lock. You can determine which loop is unlocked by examining the error messages.

4. Digital Modulation Annunciators

All digital modulation annunciators (E8267D with Option 601/602 only) appear in this location. These annunciators appear only when the modulation is active, and only one digital modulation can be active at any given time.

ARB	Dual Arbitrary Waveform Generator	M-TONE	Multitone Waveform Generator
CUSTOM	Custom Real Time I/Q Baseband	T-TONE	Two-Tone Waveform Generator
DIGMOD	Custom Arb Waveform Generator		

5. Amplitude Area

The current output power level setting is shown in this portion of the display. Indicators are also displayed in this area when amplitude offset is used, amplitude reference mode is turned on, external leveling mode is enabled, a source module is enabled, and when user flatness is enabled.

6. Error Message Area

Abbreviated error messages are reported in this space. When multiple error messages occur, only the most recent message remains displayed. Reported error messages with details can be viewed by pressing Utility > Error Info.

7. Text Area

This text area of the display:

- shows signal generator status information, such as the modulation status, sweep lists, and file catalogs
- displays the tables
- enables you to perform functions such as managing information, entering information, and displaying or deleting files

8. Softkey Label Area

The labels in this area define the function of the softkeys located immediately to the right of the label. The softkey label may change depending upon the function selected.

Rear Panel

This section describes each item on the PSG rear panel. [Figure 1-3](#) shows a standard E8267D rear panel. [Figure 1-4 on page 19](#) shows an E8267D rear panel with Option 1EM. Option 1EM moves all front panel connectors to the rear panel. Both rear panel figures include all items available on the E8257D as well.

Figure 1-3

Standard Rear Panel Diagram

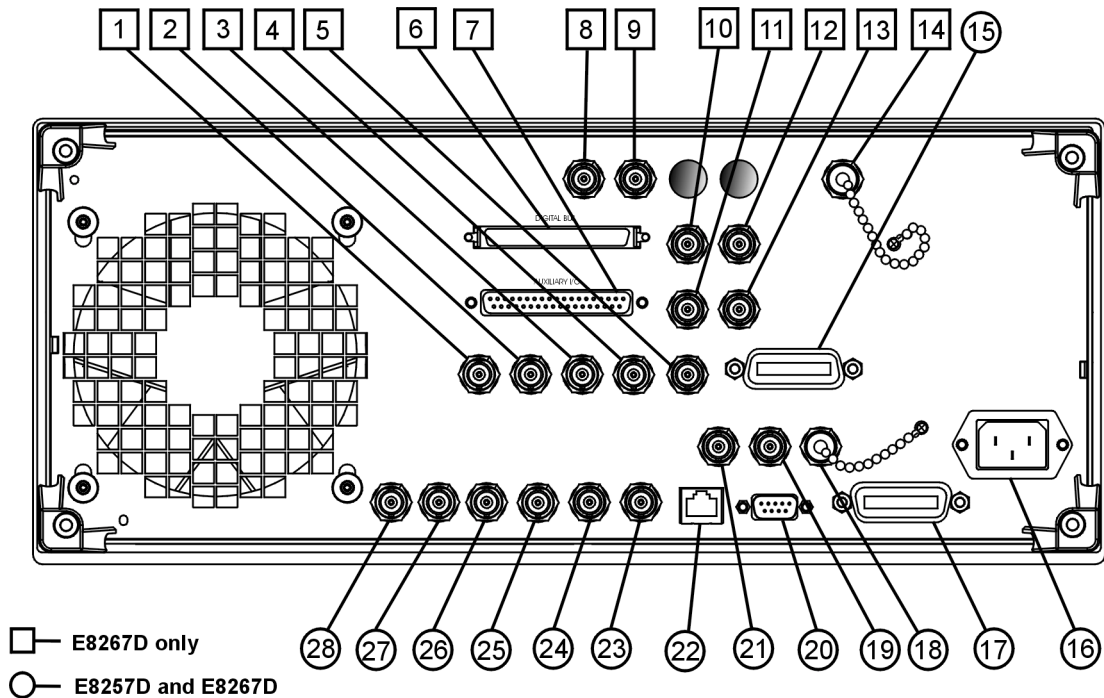

- | | | |
|------------------------|-----------------------------|-------------------------|
| 1. EVENT 1 | 10. I OUT | 19. 10 MHz IN |
| 2. EVENT 2 | 11. Q OUT | 20. AUXILIARY INTERFACE |
| 3. PATTERN TRIG IN | 12. I-bar OUT | 21. 10 MHz OUT |
| 4. BURST GATE IN | 13. Q-bar OUT | 22. LAN |
| 5. BASEBAND GEN REF IN | 14. COH CARRIER | 23. STOP SWEEP IN/OUT |
| 6. DIGITAL BUS | 15. SOURCE MODULE INTERFACE | 24. Z-AXIS BLANK/MKRS |
| 7. AUXILIARY I/O | 16. AC Power Receptacle | 25. SWEEP OUT |
| 8. WIDEBAND I INPUT | 17. GPIB | 26. TRIGGER OUT |
| 9. WIDEBAND Q INPUT | 18. 10 MHz EFC | 27. TRIGGER IN |
| | | 28. SOURCE SETTLED |

Figure 1-4 Option 1EM Rear Panel Diagram

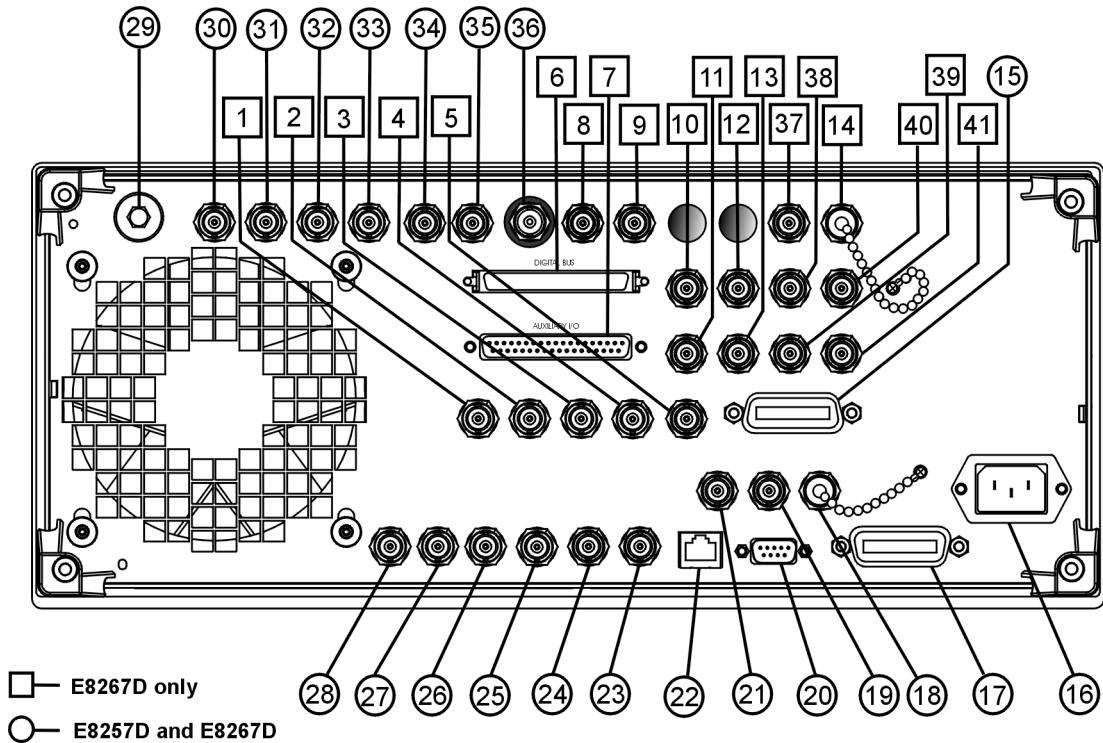

- | | | |
|------------------------|-----------------------------|---------------------------|
| 1. EVENT 1 | 15. SOURCE MODULE INTERFACE | 29. RF OUT |
| 2. EVENT 2 | 16. AC Power Receptacle | 30. EXT 1 Input |
| 3. PATTERN TRIG IN | 17. GPIB | 31. EXT 2 Input |
| 4. BURST GATE IN | 18. 10 MHz EFC | 32. LF OUT |
| 5. BASEBAND GEN REF IN | 19. 10 MHz IN | 33. PULSE SYNC OUT |
| 6. DIGITAL BUS | 20. AUXILIARY INTERFACE | 34. PULSE VIDEO OUT |
| 7. AUXILIARY I/O | 21. 10 MHz OUT | 35. PULSE/TRIG GATE INPUT |
| 8. WIDEBAND I INPUT | 22. LAN | 36. ALC INPUT |
| 9. WIDEBAND Q INPUT | 23. STOP SWEEP IN/OUT | 37. DATA |
| 10. I OUT | 24. Z-AXIS BLANK/MKRS | 38. DATA CLOCK |
| 11. Q OUT | 25. SWEEP OUT | 39. SYMBOL SYNC |
| 12. I-bar OUT | 26. TRIGGER OUT | 40. I Input |
| 13. Q-bar OUT | 27. TRIGGER IN | 41. Q Input |
| 14. COH CARRIER | 28. SOURCE SETTLED | |

1. EVENT 1

This female BNC connector (E8267D only) is used with an internal baseband generator (Option 601/602); on signal generators without Option 601/602, this female BNC connector is non-functional.

In real-time mode, the EVENT 1 connector outputs a pattern or frame synchronization pulse for triggering or gating external equipment. It may be set to start at the beginning of a pattern, frame, or timeslot and is adjustable to within \pm one timeslot with one bit resolution.

In arbitrary waveform mode, the EVENT 1 connector outputs a timing signal generated by Marker 1. A marker (3.3 V CMOS high for both positive and negative polarity) is output on the EVENT 1 connector whenever a Marker 1 is turned on in the waveform.

The reverse damage levels for this connector are $> +8$ V and < -4 V. The nominal output impedance is not defined.

2. EVENT 2

This female BNC connector (E8267D only) is used with an internal baseband generator (Option 601/602); on signal generators without Option 601/602, this female BNC connector is non-functional.

In real-time mode, the EVENT 2 connector outputs a data enable signal for gating external equipment. This is applicable when external data is clocked into internally generated timeslots. Data is enabled when the signal is low.

In arbitrary waveform mode, the EVENT 2 connector outputs a timing signal generated by Marker 2. A marker (3.3 V CMOS high for both positive and negative polarity) is output on the EVENT 2 connector whenever a Marker 2 is turned on in the waveform.

The reverse damage levels for this connector are $> +8$ V and < -4 V. The nominal output impedance is not definable.

3. PATTERN TRIG IN

This female BNC connector (E8267D only) is used with an internal baseband generator (Option 601/602); on signal generators without Option 601/602, this female BNC connector is non-functional. This connector accepts a signal that triggers an internal pattern or frame generator to start a single-pattern output. Minimum pulse width is 100 ns. Damage levels are $> +5.5$ V and < -0.5 V. The nominal input impedance is not definable.

4. BURST GATE IN

This female BNC connector (E8267D only) is used with an internal baseband generator (Option 601/602). On signal generators without Option 601/602, this connector is non-functional. This connector accepts a 3-volt CMOS input signal for gating burst power. Burst gating is used when you are externally supplying data and clock information.

The input signal must be synchronized with the external data input that will be output during the burst. The burst power envelope and modulated data are internally delayed and re-synchronized. The input signal must be CMOS high for normal burst RF power or CW RF output power and CMOS low for RF off. Damage levels are $> +5.5$ V and < -0.5 V. The nominal input impedance is not definable.

5. BASEBAND GEN REF IN

This female BNC connector (E8267D only) is used with an internal baseband generator (Option 601/602); on signal generators without Option 601/602, this female BNC connector is non-functional. This connector accepts a 0 to +20 dBm sine wave or TTL square wave signal from an external timebase reference. This external timebase reference clock is used by the internal baseband generator for both component and receiver test applications (only the internal baseband generator can be locked to this external reference; the RF frequency remains locked to the 10 MHz reference).

This connector accepts rates from 250 kHz through 100 MHz; the nominal input impedance is 50 ohms at 13 MHz, ac-coupled. The internal clock for the arbitrary waveform generator is locked to this signal when external reference is selected in the ARB setup. The minimum pulse width must be > 10 ns. The damage levels are > +8 V and < -8 V.

6. DIGITAL BUS

This is a proprietary bus used for Agilent Baseband Studio products, which require an E8267D with Options 003/004 and 601/602. This connector is not operational for general-purpose customer use. Signals are present only when a Baseband Studio option is installed (for details, refer to <http://www.agilent.com/find/basebandstudio>). The DIG BUS annunciator appears on the display when the Digital Bus is active (and the internal oven reference oscillator is not cold—OVEN COLD appears in this same location).

7. AUXILIARY I/O

This female 37-pin connector (E8267D only) is active only on instruments with an internal baseband generator (Option 601/602); on signal generators without Option 601/602, this connector is non-functional. This connector provides access to the inputs and outputs described in the following figure.

Figure 1-5 Auxiliary I/O Connector (Female 37-Pin)

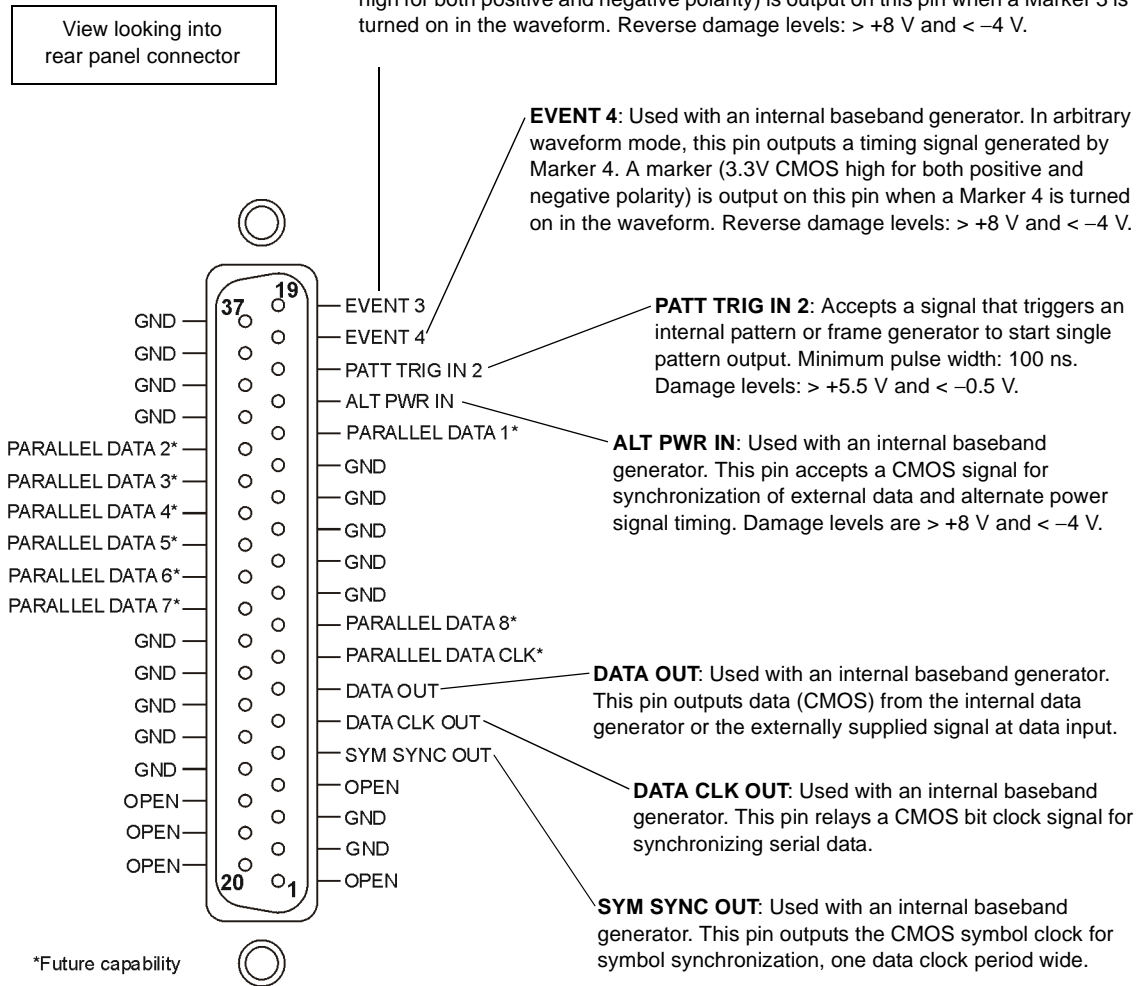

8. WIDEBAND I INPUT

This female BNC connector (E8267D only) is used with wideband external I/Q inputs (Option 015). It accepts wideband AM and allows direct high-bandwidth analog inputs to the I/Q modulator in the 3.2–44 GHz range (frequency limit is dependant on the option). This input is not calibrated. The recommended power level at the input is 0 dBm with a +/- 1 volt maximum amplitude. On signal generators without Option 015, this connector is non-functional. The nominal impedance for this connector is 50 ohms.

The signal generator uses lowside mixing in the 20–28.5 GHz frequency range (Options 532 and 544), which reverses the phase relationship for I and Q signals. For internally generated I/Q signals the signal generator's firmware compensates for this. However, for wideband external I/Q inputs (Option 015) there is no compensation and the I and Q inputs at the rear panel must be swapped to maintain the correct phase relationships in this frequency band. Refer to the A37 Upconverter description in the E8257D/67D PSG Service Guide and Option 015 data sheet for more information.

9. WIDEBAND Q INPUT

This female BNC connector (E8267D only) is used with wideband external I/Q inputs (Option 015); on signal generators without Option 015, this female BNC connector is non-functional. The female BNC connector allows direct high-bandwidth analog inputs to the I/Q modulator in the 3.2 to 44 GHz frequency range (frequency limit is dependant on the option). This input is not calibrated. The recommended power level at the input is 0 dBm with a +/- 1 volt maximum amplitude. The nominal impedance for this connector is 50 ohms. Refer to the above description for the wideband I input for more information.

10. I OUT

This female BNC connector (E8267D only) can be used with an internal baseband generator (Option 601/602) to output the analog, in-phase component of I/Q modulation; on signal generators without Option 601/602, this female BNC connector can be used to output the in-phase component of an external I/Q modulation that has been fed into the I input connector. The nominal output impedance of the I OUT connector is 50 ohms, dc-coupled.

11. Q OUT

This female BNC connector (E8267D only) can be used with an internal baseband generator (Option 601/602) to output the analog, quadrature-phase component of I/Q modulation; on signal generators without Option 601/602, this female BNC connector can be used to output the quadrature-phase component of an external I/Q modulation that has been fed into the Q input connector. The nominal output impedance of the Q OUT connector is 50 ohms, dc-coupled.

12. I-bar OUT

This female BNC connector (E8267D only) can be used with an internal baseband generator (Option 601/602) to output the complement of the analog, in-phase component of I/Q modulation; on signal generators without Option 601/602, this female BNC connector can be used to output the complement of the in-phase component of an external I/Q modulation that has been fed into the I input connector.

I-bar OUT is used in conjunction with I OUT to provide a balanced baseband stimulus. Balanced signals are signals present in two separate conductors that are symmetrical relative to ground and are opposite in polarity (180 degrees out of phase). The nominal output impedance of the I-bar OUT connector is 50 ohms, dc-coupled.

13. Q-bar OUT

This female BNC connector (E8267D only) can be used with an internal baseband generator (Option 601/602) to output the complement of the analog, quadrature-phase component of I/Q modulation; on signal generators without Option 601/602, this female BNC connector can be used to output the complement of the quadrature-phase component of an external I/Q modulation that has been fed into the Q input connector.

Q-bar OUT is used in conjunction with Q OUT to provide a balanced baseband stimulus. Balanced signals are signals present in two separate conductors that are symmetrical relative to ground and are opposite in polarity (180 degrees out of phase). The nominal output impedance of the Q-bar OUT connector is 50 ohms, dc-coupled.

14. COH CARRIER

This female SMA connector (E8267D with Option UNT only) outputs an RF signal that is phase coherent with the signal generator carrier. The coherent carrier connector outputs RF that is not modulated with AM, pulse, or I/Q modulation, but is modulated with FM or Φ M (when FM or Φ M are on).

The output power is nominally 0 dBm. The output frequency range is from 249.99900001 MHz to 3.2 GHz; this output is not useful for output frequencies > 3.2 GHz. If the RF output frequency is below 249.99900001 MHz, the coherent carrier output signal will have the following frequency:

$$\text{Frequency of coherent carrier} = (1\text{E}9 - \text{Frequency of RF output}) \text{ in Hz.}$$

Damage levels are 20 Vdc and 13 dBm reverse RF power. The nominal output impedance of this connector is 50 ohms.

15. SOURCE MODULE INTERFACE

This interface is used to connect to compatible Agilent Technologies 83550 Series mm-wave source modules.

16. AC Power Receptacle

The ac line voltage is connected here. The power cord receptacle accepts a three-pronged power cable that is shipped with the signal generator.

17. GPIB

This GPIB interface allows listen and talk capability with compatible IEEE 488.2 devices.

18. 10 MHz EFC

This female BNC input connector accepts an external dc voltage, ranging from -5 V to +5 V, for electronic frequency control (EFC) of the internal 10 MHz reference oscillator. This voltage inversely tunes the oscillator about its center frequency approximately -0.0025 ppm/V. The nominal input impedance is greater than 1 Mohms. When not in use, this connector should be shorted using the supplied shorting cap to assure a stable operating frequency. This connector is available only with Option UNR/UNX.

19. 10 MHz IN

This female BNC connector accepts an external timebase reference input signal level of > -3 dBm. The reference must be 1, 2, 2.5, 5, or 10 MHz, within ± 1 ppm. The signal generator detects when a valid reference signal is present at this connector and automatically switches from internal to external reference operation.

For Option UNR/UNX, this BNC connector accepts a signal with a nominal input level of 5 ± 5 dBm. The external frequency reference must be 10 MHz, within ± 1 ppm.

The nominal input impedance is 50 ohms with a damage level of ≥ 10 dBm.

20. AUXILIARY INTERFACE

This 9-pin D-subminiature female connector is an RS-232 serial port that can be used for serial communication and Master/Slave source synchronization.

Table 1-3 Auxiliary Interface Connector

Pin Number	Signal Description	Signal Name
1	No Connection (default operation)/ Retrace (Master/Slave operation)	
2	Receive Data	RECV
3	Transmit Data	XMIT
4	+5V (Default operation)/ Sweep Stop (Master/Slave operation)	
5	Ground, 0V	
6	No Connection	
7	Request to Send	RTS
8	Clear to Send	CTS
9	No Connection	

Figure 1-6

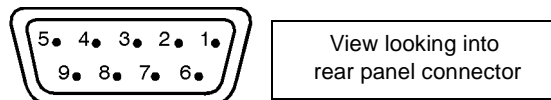

21. 10 MHz OUT

This female BNC connector outputs a nominal signal level of $> +4$ dBm and has an output impedance of 50 ohms. The accuracy is determined by the timebase used.

22. LAN

This LAN interface allows ethernet local area network communication through a 10Base-T LAN cable. The yellow LED on the interface illuminates when data transmission (transfer/receive) is present. The green LED illuminates when there is a delay in data transmission or no data transmission is present.

23. STOP SWEEP IN/OUT

This female BNC connector (Option 007 only) provides an open-collector, TTL-compatible input/output signal that is used during ramp sweep operation. It provides low-level (nominally 0 V) output during sweep retrace and band-cross intervals. It provides high-level (nominally +5 V) output during the forward portion of sweep. Sweep stops when this input/output connector is grounded externally. When operating as an input, the nominal impedance for this connector is less than 10 ohms. When operating as an output, the nominal impedance is approximately 4.2 kohms.

24. Z-AXIS BLANK/MKRS

This female BNC connector (Option 007 only) supplies a +5 V (nominal) level during retrace and band-switch intervals of a step, list, or ramp sweep. During ramp sweep, this female BNC connector supplies a -5 V (nominal) level when the RF frequency is at a marker frequency and intensity marker mode is on. This signal is derived from an operational amplifier output so the load impedance should be greater than or equal to 5 kohms. This connection is most commonly used to interface with an Agilent 8757D Scalar Network Analyzer.

25. SWEEP OUT

This female BNC connector outputs a voltage proportional to the RF power or frequency sweep ranging from 0 V at the start of sweep and goes to +10 V (nominal) at the end of sweep, regardless of sweep width.

The nominal output impedance is less than 1 ohm and can drive a 2-kohm load.

When connected to an Agilent Technologies 8757D network analyzer, it generates a selectable number of equally spaced 1 ms 10 V pulses (nominal) across a ramp (analog) sweep. The number of pulses can be set from 101 to 1601 by remote control through the 8757D.

26. TRIGGER OUT

This female BNC connector, in step/list sweep mode, outputs a TTL signal that is high at the start of a dwell sequence or when waiting for a point trigger in manual sweep mode. The signal is low when the dwell is over or when a point trigger is received. In ramp sweep mode, the output provides 1601 equally spaced 1 μ s pulses (nominal) across a ramp sweep. When using LF Out, the output provides a 2 μ s pulse at the start of LF sweep. The nominal impedance for this connector is less than 10 ohms.

On signal generators with Option 1EM, this output is changed from a BNC to an SMB connector.

27. TRIGGER IN

This female BNC connector accepts a 3.3V CMOS signal, which is used for point-to-point triggering in manual sweep mode, or in an low-frequency (LF output) or analog (AM, FM, and Φ M) external sweep trigger setup. Triggering can occur on either the positive or negative edge of the signal start. The damage level is ≤ -4 V or $\geq +10$ V. The nominal input impedance for this connector is approximately 4.2 kohms.

28. SOURCE SETTLED

This female BNC connector provides a 3-volt CMOS output trigger, indicating when the signal generator has settled to a new frequency or power level. A high indicates that the source has not settled. A low indicates that the source has settled. The nominal output impedance for this connector is less than 10 ohms.

29. RF OUT

On standard instruments, this connector resides on the front panel. For a description of this connector, see [“18. RF OUTPUT” on page 10](#).

30. EXT 1 Input

On standard instruments, this connector resides on the front panel. For a description of this connector, see [“11. EXT 1 INPUT” on page 9](#).

31. EXT 2 Input

On standard instruments, this connector resides on the front panel. For a description of this connector, see [“12. EXT 2 INPUT” on page 9](#).

32. LF OUT

On standard instruments, this connector resides on the front panel. For a description of this connector, see [“13. LF OUTPUT” on page 10](#).

33. PULSE SYNC OUT

On standard instruments, this connector resides on the front panel. For a description of this connector, see [“19. SYNC OUT” on page 10](#).

34. PULSE VIDEO OUT

On standard instruments, this connector resides on the front panel. For a description of this connector, see [“20. VIDEO OUT” on page 11](#).

35. PULSE/TRIG GATE INPUT

On standard instruments, this connector resides on the front panel. For a description of this connector, see [“22. GATE/ PULSE/ TRIGGER INPUT” on page 11](#).

36. ALC INPUT

On standard instruments, this connector resides on the front panel. For a description of this connector, see [“15. ALC INPUT” on page 10](#).

37. DATA

On standard instruments, this connector resides on the front panel. For a description of this connector, see [“35. DATA” on page 12](#).

38. DATA CLOCK

On standard instruments, this connector resides on the front panel. For a description of this connector, see [“34. DATA CLOCK” on page 12](#).

39. SYMBOL SYNC

On standard instruments, this connector resides on the front panel. For a description of this connector, see [“33. SYMBOL SYNC” on page 12](#).

40. I Input

On standard instruments, this connector resides on the front panel. For a description of this connector, see [“37. I Input” on page 13](#).

41. Q Input

On standard instruments, this connector resides on the front panel. For a description of this connector, see [“36. Q Input” on page 13](#).

2 Basic Operation

In the following sections, this chapter describes operations common to all Agilent PSG signal generators:

- [“Using Table Editors” on page 30](#)
- [“Configuring a Continuous Wave RF Output” on page 32](#)
- [“Configuring a Swept RF Output” on page 34](#)
- [“Using Ramp Sweep \(Option 007\)” on page 39](#)
- [“Extending the Frequency Range” on page 49](#)
- [“Turning On a Modulation Format” on page 49](#)
- [“Applying a Modulation Format to the RF Output” on page 50](#)
- [“Using Data Storage Functions” on page 51](#)
- [“Using the Instrument State Registers” on page 53](#)
- [“Using Security Functions” on page 55](#)
- [“Enabling Options” on page 61](#)
- [“Using the Web Server” on page 62](#)

Using Table Editors

Table editors simplify configuration tasks, such as creating a list sweep. This section provides information to familiarize you with basic table editor functionality using the List Mode Values table editor as an example.

Press Preset > Sweep/List > Configure List Sweep.

The signal generator displays the List Mode Values table editor, as shown below.

Figure 2-1

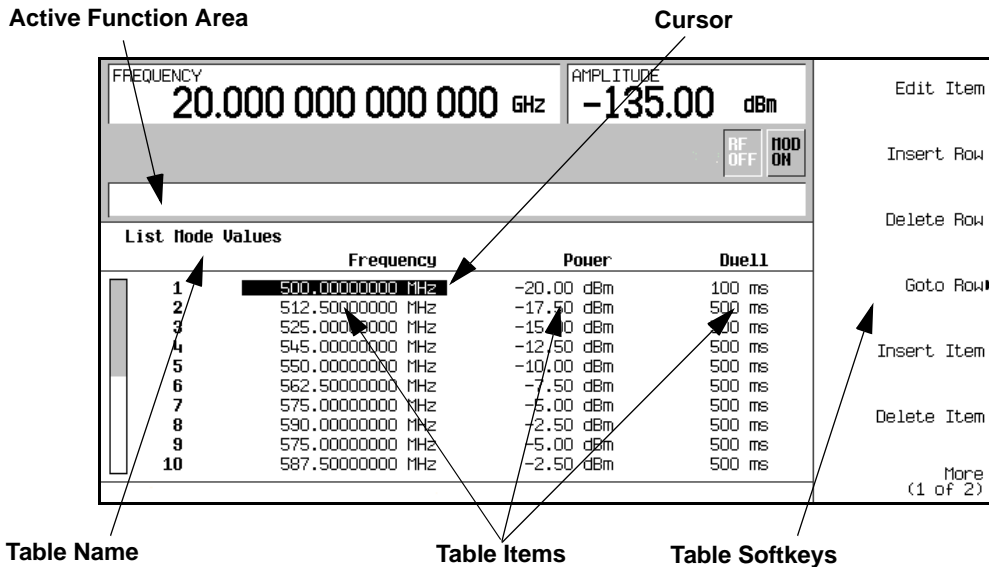

Active Function Area

displays the active table item while its value is edited

Cursor

an inverse video identifier used to highlight specific table items for selection and editing

Table Softkeys

select table items, preset table values, and modify table structures

Table Items

values arranged in numbered rows and titled columns (The columns are also known as data fields. For example, the column below the Frequency title is known as the Frequency data field).

Table Editor Softkeys

The following table editor softkeys are used to load, navigate, modify, and store table item values.

Edit Item	displays the selected item in the active function area of the display where the item's value can be modified
Insert Row	inserts an identical row of table items above the currently selected row
Delete Row	deletes the currently selected row
Goto Row	opens a menu of softkeys (Enter , Goto Top Row , Goto Middle Row , Goto Bottom Row , Page Up , and Page Down) used to quickly navigate through the table items
Insert Item	inserts an identical item in a new row below the currently selected item
Delete Item	deletes the currently selected item
Page Up and Page Down	displays table items that occupy rows outside the limits of the ten-row table display area
More (1 of 2)	accesses Load/Store and its associated softkeys
Load/Store	opens a menu of softkeys (Load From Selected File , Store To File , Delete File , Goto Row , Page Up , and Page Down) used to load table items from a file in the memory catalog, or to store the current table items as a file in the memory catalog

Modifying Table Items in the Data Fields

1. If not already displayed, open the List Mode Values table editor ([Figure 2-1 on page 30](#)):
Press **Preset** > **Sweep/List** > **Configure List Sweep**
2. Use the arrow keys or the knob to move the table cursor over the desired item.
In [Figure 2-1](#), the first item in the Frequency data field is selected.
3. Press **Edit Item**.
The selected item is displayed in the active function area of the display.
4. Use the knob, arrow keys, or the numeric keypad to modify the value.
5. Press **Enter**.
The modified item is now displayed in the table.

Configuring the RF Output

This section provides information on how to create continuous wave and swept RF (page 34) outputs. It also has information on using a mm-Wave source module to extend the signal generator's frequency range (page 49).

Configuring a Continuous Wave RF Output

These procedures demonstrate how to set the following parameters:

- RF output frequency
- frequency reference and frequency offset (page 33)
- RF output amplitude (page 33)
- amplitude reference and amplitude offset (page 34)

Setting the RF Output Frequency

Set the RF output frequency to 700 MHz, and increment or decrement the output frequency in 1 MHz steps.

1. Return the signal generator to the factory-defined state: Press **Preset**.

NOTE You can change the preset condition of the signal generator to a user-defined state. For these examples, however, use the factory-defined preset state (set the **Preset Normal User** softkey in the Utility menu to Normal).

2. Observe the **FREQUENCY** area of the display (in the upper left-hand corner).

The value displayed is the maximum specified frequency of the signal generator.

3. Press **RF On/Off**.

The **RF On/Off** hardkey must be pressed before the RF signal is available at the RF OUTPUT connector. The display annunciator changes from **RF OFF** to **RF ON**. The maximum specified frequency should be output at the RF OUTPUT connector (at the signal generator's minimum power level).

4. Press **Frequency > 700 > MHz**.

The 700 MHz RF frequency should be displayed in the **FREQUENCY** area of the display and also in the active entry area.

5. Press **Frequency > Incr Set > 1 > MHz**.

This changes the frequency increment value to 1 MHz.

6. Press the up arrow key.

Each press of the up arrow key increases the frequency by the increment value last set with the **Incr Set** hardkey. The increment value is displayed in the active entry area.

7. The down arrow decreases the frequency by the increment value set in the previous step. Practice stepping the frequency up and down in 1 MHz increments.

You can also adjust the RF output frequency using the knob. As long as frequency is the active function (the frequency is displayed in the active entry area), the knob will increase and decrease the RF output frequency.

8. Use the knob to adjust the frequency back to 700 MHz.

Setting the Frequency Reference and Frequency Offset

The following procedure sets the RF output frequency as a reference frequency to which all other frequency settings are relative. When the frequency reference is set, the display will read 0.00 Hz (the frequency output of the signal generator's hardware minus the reference frequency). Although the display changes, the actual frequency output is 700 MHz (from step 8 above). Any subsequent frequency changes are shown as increments or decrements to the 0 Hz reference.

The Frequency Reference Set function is not an active function. Once it is set, any change to the frequency setting appears as a frequency reading on the signal generator's front-panel display. For example,

1. Preset the signal generator: Press **Preset**.

2. Set the frequency reference to 700 MHz:

Press: **Frequency > 700 > MHz > More (1 of 3) > Freq Ref Set**.

This activates the frequency reference mode, sets the output frequency (700 MHz) as the reference value, and toggles the **Freq Ref** softkey On. The **FREQUENCY** area displays 0.000 Hz. This reading is the frequency output of the signal generator's hardware (700 MHz) minus the reference value (700 MHz). The signal generator's true output frequency is 700 MHz. If the **Freq Ref** softkey is toggled to Off, the front-panel will indicate the actual frequency: 700 MHz. The **REF** indicator appears on the front-panel display and the **Freq Ref Off On** softkey toggles to On.

3. Turn on the RF output: Press **RF On/Off**.

The display annunciator changes from **RF OFF** to **RF ON**. The RF frequency at the **RF OUTPUT** connector is 700 MHz.

4. Set the frequency increment value to 1 MHz: Press **Frequency > Incr Set > 1 > MHz**.
5. Increment the output frequency by 1 MHz: Press the up arrow key.

The **FREQUENCY** area display changes to show 1.000 000 000 MHz, which is the frequency output by the hardware (700 MHz + 1 MHz) minus the reference frequency (700 MHz). The frequency at the **RF OUTPUT** changes to 701 MHz.

6. Enter a 1 MHz offset: Press **More (1 of 3) > Freq Offset > 1 > MHz**.

The **FREQUENCY** area displays 2.000 000 00 MHz, which is the frequency output by the hardware (701 MHz) minus the reference frequency (700 MHz) plus the offset (1 MHz). The **OFFS** indicator activates. The frequency at the **RF OUTPUT** connector is still 701 MHz.

Setting the RF Output Amplitude

1. Preset the signal generator: Press **Preset**.

The **AMPLITUDE** area of the display shows the minimum power level of the signal generator. This is the normal preset RF output amplitude.

2. Turn on the RF output: Press **RF On/Off**.

The display annunciator changes to **RF ON**. At the **RF OUTPUT** connector, the RF signal is output at the minimum power level.

3. Change the amplitude to -20 dBm: Press **Amplitude** > -20 > **dBm**.

The new output power displays in the **AMPLITUDE** area of the display and in the active entry area. Until you press a different front panel function key, amplitude remains the active function. You can also change the amplitude using the up and down arrow keys or the knob.

Setting the Amplitude Reference and Amplitude Offset

The following procedure sets the RF output power as an amplitude reference to which all other amplitude parameters are relative. The amplitude initially shown on the display is 0 dB (the power output by the hardware minus the reference power). Although the display changes, the output power does *not* change. Any subsequent power changes are shown as incremental or decremental to 0 dB.

1. Press **Preset**.
2. Set the amplitude to -20 dBm: Press **Amplitude** > -20 > **dBm**.
3. Activate the amplitude reference mode and set the current output power (-20 dBm) as the reference value: Press **More (1 of 2)** > **Ampl Ref Set**.

The **AMPLITUDE** area displays 0.00 dB, which is the power output by the hardware (-20 dBm) minus the reference value (-20 dBm). The **REF** indicator activates and the **Ampl Ref Off On** softkey toggles On.

4. Turn the RF output on: Press **RF On/Off**.
The display annunciator changes to **RF ON**. The power at the **RF OUTPUT** connector is -20 dBm.
5. Change the amplitude increment value to 10 dB: Press **Incr Set** > **10** > **dB**.
6. Use the up arrow key to increase the output power by 10 dB.

The **AMPLITUDE** area displays 10.00 dB, which is the power output by the hardware (-20 dBm plus 10 dBm) minus the reference power (-20 dBm). The power at the **RF OUTPUT** connector changes to -10 dBm.

7. Enter a 10 dB offset: Press **Ampl Offset** > **10** > **dB**.

The **AMPLITUDE** area displays 20.00 dB, which is the power output by the hardware (-10 dBm) minus the reference power (-20 dBm) plus the offset (10 dB). The **OFFS** indicator activates. The power at the **RF OUTPUT** connector is still -10 dBm.

Configuring a Swept RF Output

A PSG signal generator has up to three sweep types: step sweep, list sweep, and ramp sweep (Option 007).

The signal generator indicates the sweep advance in a progress bar on the front-panel display. If the sweep time is greater than one second, the progress bar sweep advances according to the frequency span of each segment. For each segment in the span, the progress bar displays the full segment and then the sweep is taken. With sweep times less than one second, the progress bar is drawn, the sweep taken, and the progress bar is then blanked.

NOTE List sweep data cannot be saved within an instrument state, but *can* be saved to the memory catalog. For instructions on saving list sweep data, see “Storing Files to the Memory Catalog” on page 52.

During swept RF output, the FREQUENCY and AMPLITUDE areas of the signal generator’s display are deactivated, depending on what is being swept.

Step sweep (see page 35) and ramp sweep (see page 37) provide a linear progression through the start-to-stop frequency and/or amplitude values, while list sweep enables you to create a list of arbitrary frequency, amplitude, and dwell time values and sweep the RF output based on that list.

The list sweep example uses the points created in the step sweep example as the basis for a new list sweep.

Ramp sweep (see page 39) is faster than step or list sweep, and is designed to work with an 8757D Scalar Network Analyzer.

The signal generator provides a softkey, Sweep Retrace Off On, that lets you configure single sweep behavior. When sweep retrace is on, the signal generator will retrace the sweep to the first point of the sweep. If the sweep retrace is off, the sweep will stop and remain on the last point in the sweep.

Activating Scalar Pulse in Sweep Configurations

If your sweep setup uses a scalar network analyzer and a DC detector, the PSG must modulate the swept signal with a 27 kHz square wave, also referred to as a scalar pulse. This pulse modulation is necessary for the DC detector to properly detect the swept signal. If the PSG is controlled by an 8757D through a GPIB connection, the scalar pulse automatically turns on when DC detection is selected on the 8757D. When using any other scalar analyzer, you can manually turn on the scalar pulse using either one of the following key-press sequences:

Press Sweep/List > Sweep Type > Scalar Pulse Off On to On

or

Press Pulse > Pulse Source > Scalar > Pulse Off On to On

Using Step Sweep

Step sweep provides a linear progression through the start-to-stop frequency and/or amplitude values. You can toggle the direction of the sweep, up or down. When the Sweep Direction Down Up softkey is set to Up, values are swept from the start amplitude/frequency to the stop amplitude/frequency. When set to Down, values are swept from the stop amplitude/frequency to the start amplitude/frequency.

When a step sweep is activated, the signal generator sweeps the RF output based on the values entered for RF output start and stop frequencies and amplitudes, a number of equally spaced points (steps) to dwell upon, and the amount of dwell time at each point; dwell time is the minimum period of time after the settling time that the signal generator will remain at its current state. The frequency, amplitude, or frequency *and* amplitude of the RF output will sweep from the start amplitude/frequency to the stop amplitude/frequency, dwelling at equally spaced intervals defined by the #Points softkey value.

To Configure a Single Step Sweep

In this procedure, you create a step sweep with nine, equally-spaced points, and the following parameters:

- frequency range from 500 MHz to 600 MHz
 - amplitude from -20 dBm to 0 dBm
 - dwell time 500 ms at each point
1. Press **Preset**.
 2. Press **Sweep/List**.
This opens a menu of sweep softkeys.
 3. Press **Sweep Repeat Single Cont**.
This toggles the sweep repeat from continuous to single.
 4. Press **Configure Step Sweep**.
 5. Press **Freq Start > 500 > MHz**.
This changes the start frequency of the step sweep to 500 MHz.
 6. Press **Freq Stop > 600 > MHz**.
This changes the stop frequency of the step sweep to 600 MHz.
 7. Press **Ampl Start > -20 > dBm**.
This changes the amplitude level for the start of the step sweep.
 8. Press **Ampl Stop > 0 > dBm**.
This changes the amplitude level for the end of the step sweep.
 9. Press **# Points > 9 > Enter**.
This sets the number of sweep points to nine.
 10. Press **Step Dwell > 500 > msec**.
This sets the dwell time at each point to 500 milliseconds.
 11. Press **Return > Sweep > Freq & Ampl**.
This sets the step sweep to sweep both frequency and amplitude data. Selecting this softkey returns you to the previous menu and turns on the sweep function.
 12. Press **RF On/Off**.
The display annunciator changes from RF OFF to RF ON.
 13. Press **Single Sweep**.

A single sweep of the frequencies and amplitudes configured in the step sweep is executed and available at the RF OUTPUT connector. On the display, the SWEEP annunciator appears for the duration of the sweep and a progress bar shows the progression of the sweep. The **Single Sweep** softkey can also be used to abort a sweep in progress. To see the frequencies sweep again, press **Single Sweep** to trigger the sweep.

To Configure a Continuous Step Sweep

Press **Sweep Repeat Single Cont.**

This toggles the sweep from single to continuous. A continuous repetition of the frequencies and amplitudes configured in the step sweep are now available at the RF OUTPUT connector. The SWEEP annunciator appears on the display, indicating that the signal generator is sweeping and progression of the sweep is shown by a progress bar.

Using List Sweep

List sweep enables you to create a list of arbitrary frequency, amplitude, and dwell time values and sweep the RF output based on the entries in the List Mode Values table.

Unlike a step sweep that contains linear ascending/descending frequency and amplitude values, spaced at equal intervals throughout the sweep, list sweep frequencies and amplitudes can be entered at unequal intervals, nonlinear ascending/descending, or random order.

For convenience, the List Mode Values table can be copied from a previously configured step sweep. Each step sweep point's associated frequency, amplitude and dwell time values are entered into a row in the List Mode Values table, as the following example illustrates.

To Configure a Single List Sweep Using Step Sweep Data

In this procedure, you will leverage the step sweep points and change the sweep information by editing several points in the List Mode Values table. For information on using tables, see [“Using Table Editors” on page 30](#).

1. Press **Sweep Repeat Single Cont.**

This toggles the sweep repeat from continuous to single. The SWEEP annunciator is turned off. The sweep will not occur until it is triggered.

2. Press **Sweep Type List Step.**

This toggles the sweep type from step to list.

3. Press **Configure List Sweep.**

This opens another menu displaying softkeys that you will use to create the sweep points. The display shows the current list data. (When no list has been previously created, the default list contains one point set to the signal generator's maximum frequency, minimum amplitude, and a dwell time of 2 ms.)

4. Press **More (1 of 2) > Load List From Step Sweep > Confirm Load From Step Data.**

The points you defined in the step sweep are automatically loaded into the list.

To Edit List Sweep Points

1. Press **Return > Sweep > Off.**

Turning the sweep off allows you to edit the list sweep points without generating errors. If sweep remains on during editing, errors occur whenever one or two point parameters (frequency, power, and dwell) are undefined.

2. Press **Configure List Sweep.**

This returns you to the sweep list table.

3. Use the arrow keys to highlight the dwell time in row 1.
4. Press **Edit Item**.
The dwell time for point 1 becomes the active function.
5. Press **100 > msec**.
This enters 100 ms as the new dwell time value for row 1. Note that the next item in the table (in this case, the frequency value for point 2) becomes highlighted after you press the terminator softkey.
6. Using the arrow keys, highlight the frequency value in row 4.
7. Press **Edit Item > 545 > MHz**.
This changes the frequency value in row 4 to 545 MHz.
8. Highlight any column in the point 7 row and press **Insert Row**.
This adds a new point between points 7 and 8. A copy of the point 7 row is placed between points 7 and 8, creating a new point 8, and renumbering the successive points.
9. Highlight the frequency item for point 8, then press **Insert Item**.
Pressing **Insert Item** shifts frequency values down one row, beginning at point 8. Note that the original frequency values for both points 8 and 9 shift down one row, creating an entry for point 10 that contains only a frequency value (the power and dwell time items do not shift down).
The frequency for point 8 is still active.
10. Press **590 > MHz**.
11. Press **Insert Item > -2.5 > dBm**.
This inserts a new power value at point 8 and shifts down the original power values for points 8 and 9 by one row.
12. Highlight the dwell time for point 9, then press **Insert Item**.
A duplicate of the highlighted dwell time is inserted for point 9, shifting the existing value down to complete the entry for point 10.

To Configure a Single List Sweep

1. Press **Return > Sweep > Freq & Ampl**.
This turns the sweep on again. No errors should occur if all parameters for every point have been defined in the previous editing process.
2. Press **Single Sweep**.
The signal generator will single sweep the points in your list. The **SWEEP** annunciator activates during the sweep.
3. Press **More (1 of 2) > Sweep Trigger > Trigger Key**.
This sets the sweep trigger to occur when you press the **Trigger** hardkey.
4. Press **More (2 of 2) > Single Sweep**.
This arms the sweep. The **ARMED** annunciator is activated.

5. Press the **Trigger** hardkey.

The signal generator will single sweep the points in your list and the **SWEEP** annunciator will be activated during the sweep.

To Configure a Continuous List Sweep

Press **Sweep Repeat Single Cont.**

This toggles the sweep from single to continuous. A continuous repetition of the frequencies and amplitudes configured in the list sweep are now available at the RF OUTPUT connector. The **SWEEP** annunciator appears on the display, indicating that the signal generator is sweeping and progression of the sweep is shown by a progress bar.

Using Ramp Sweep (Option 007)

Ramp sweep provides a linear progression through the start-to-stop frequency and/or amplitude values. Ramp sweep is much faster than step or list sweep, and is designed to work with an 8757D Scalar Network Analyzer. This section describes the ramp sweep capabilities available in PSG signal generators with Option 007. You will learn how to use basic ramp sweep, and how to configure a ramp sweep for a master/slave setup (see [page 46](#)).

Refer to the *E8257D/67D PSG Signal Generators Programming Guide* for an example program that uses pass-thru commands in a ramp sweep system (pass-thru commands enable you to temporarily interrupt ramp sweep system interaction so that you can send operating instructions to the PSG).

Using Basic Ramp Sweep Functions

This procedure demonstrates the following tasks (each task builds on the previous task):

- “[Configuring a Frequency Sweep](#)” on [page 39](#)
- “[Using Markers](#)” on [page 42](#)
- “[Adjusting Sweep Time](#)” on [page 44](#)
- “[Using Alternate Sweep](#)” on [page 45](#)
- “[Configuring an Amplitude Sweep](#)” on [page 46](#)

Configuring a Frequency Sweep

1. Set up the equipment as shown in [Figure 2-2](#).

NOTE The PSG signal generator is not compatible with the GPIB system interface of an 8757A, 8757C, or 8757E. For these older scalar network analyzers, do not connect the GPIB cable in [Figure 2-2](#). This method provides only a subset of 8757D functionality. See the *PSG Data Sheet* for details. Use the 8757A/C/E documentation instead of this procedure.

Figure 2-2

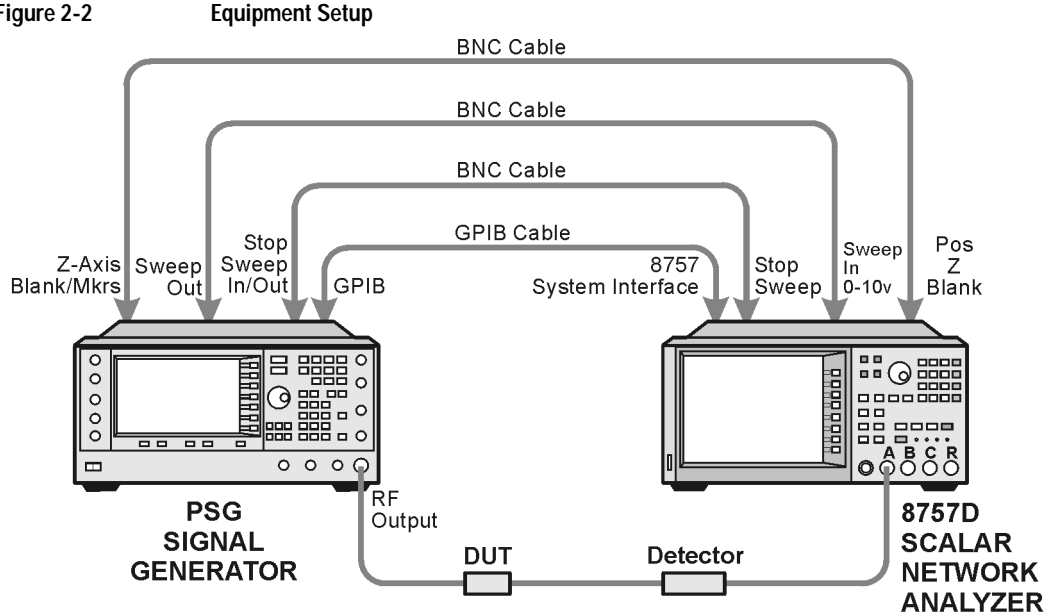

2. Turn on both the 8757D and the PSG.
3. On the 8757D, press **System > More > Sweep Mode** and verify that the **SYSINTF** softkey is set to ON.
This ensures that the system interface mode is activated on the 8757D. The system interface mode enables the instruments to work as a system.
4. Press **Utility > GPIB/RS-232 LAN** to view the PSG's GPIB address under the **GPIB Address** softkey. If you want to change it, press **GPIB Address** and change the value.
5. On the 8757D, press **LOCAL > SWEEPER** and check the GPIB address. If it does not match that of the PSG, change the value.
6. Preset either instrument.

Presetting one of the instruments should automatically preset the other as well. If both instruments do not preset, check the GPIB connection, GPIB addresses, and ensure the 8757D is set to system interface mode (**SYSINTF** set to ON).

The PSG automatically activates a 2 GHz to maximum frequency ramp sweep with a constant amplitude of 0 dBm. Notice that the **RF ON**, **SWEEP**, and **PULSE** annunciators appear on the PSG display. The **PULSE** annunciator appears because the 8757D is operating in AC mode.

The PSG also switches its remote language setting to *8757D System*, allowing the PSG to talk to the 8757D during ramp sweep operations. You can confirm this by pressing **Utility > GPIB/RS-232 LAN** and observing the selection under the **Remote Language** softkey.

NOTE During swept RF output, the **FREQUENCY** and/or **AMPLITUDE** areas of the signal generator's display are deactivated, depending on what is being swept. In this case, since frequency is being swept, nothing appears in the **FREQUENCY** area of the display.

7. Press **Frequency > Freq CW**.

The current continuous wave frequency setting now controls the RF output and ramp sweep is turned off.

8. Press **Freq Start**.

The ramp sweep settings once again control the RF output and the CW mode is turned off. Pressing any one of the softkeys **Freq Start**, **Freq Stop**, **Freq Center**, or **Freq Span** activates a ramp sweep with the current settings.

NOTE In a frequency ramp sweep, the start frequency must be lower than the stop frequency.

9. Adjust the settings for **Freq Center** and **Freq Span** so that the frequency response of the device under test (DUT) is clearly seen on the 8757D display.

Notice how adjusting these settings also changes the settings for the **Freq Start** and **Freq Stop** softkeys. You may need to rescale the response on the 8757D for a more accurate evaluation of the amplitude. [Figure 2-3 on page 42](#) shows an example of a bandpass filter response.

Figure 2-3 Bandpass Filter Response on 8757D

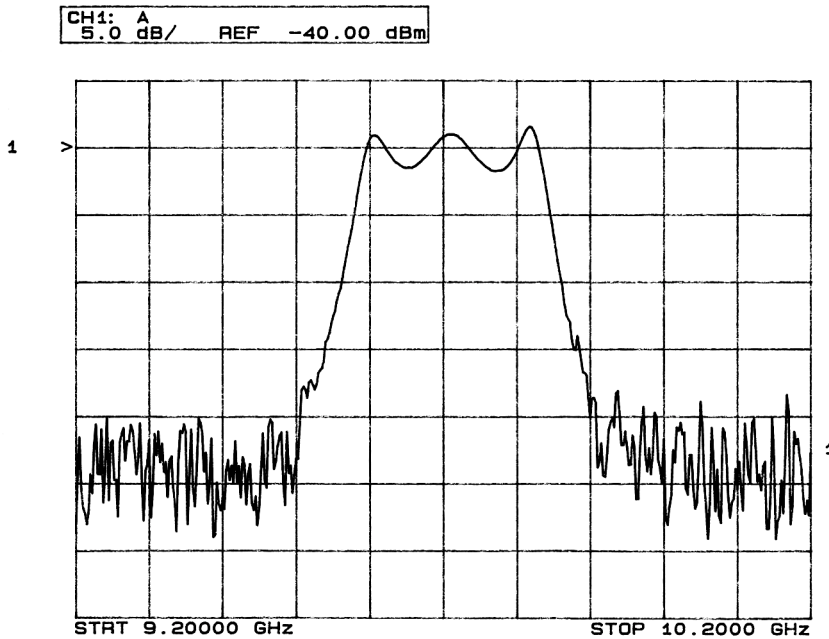

Using Markers

1. Press Markers.

This opens a table editor and associated marker control softkeys. You can use up to 10 different markers, labeled 0 through 9.

2. Press Marker Freq and select a frequency value within the range of your sweep.

In the table editor, notice how the state for marker 0 automatically turns on. The marker also appears on the 8757D display.

3. Use the arrow keys to move the cursor in the table editor to marker 1 and select a frequency value within the range of your sweep, but different from marker 0.

Notice that marker 1 is activated and is the currently selected marker, indicated by the marker arrow pointing down. As you switch between markers, using the arrow keys, you will notice that the selected marker's arrow points down, while all others point up.

Notice also that the frequency and amplitude data for the currently selected marker is displayed on the 8757D.

4. Move the cursor back to marker 0 and press **Delta Ref Set > Marker Delta Off On** to **On**.

In the table editor, notice that the frequency values for each marker are now relative to marker 0. Ref appears in the far right column (also labeled Ref) to indicate which marker is the reference. Refer to [Figure 2-4](#).

Figure 2-4 Marker Table Editor

FREQUENCY		AMPLITUDE		Marker Freq
		0.00 dBm		
SWEEP		PULSE		Marker On/Off
		RF ON MOD ON		
				Delta Ref Set
Frequency Start: 9.2000000000GHz		Stop: 10.2000000000GHz		Turn Off Markers
Frequency Center: 9.7000000000GHz		Span: 1.0000000000GHz		
Marker	Marker Frequency	On/Off	Ref	
0	0.00 Hz	ON	Ref	
1	121.92192202 MHz	ON	---	Marker Delta Off On
2	-9.12605105105 GHz	OFF	---	
3	-9.12605105105 GHz	OFF	---	Marker->Center Freq
4	-9.12605105105 GHz	OFF	---	
5	-9.12605105105 GHz	OFF	---	
6	-9.12605105105 GHz	OFF	---	
7	-9.12605105105 GHz	OFF	---	More (1 of 2)

5. Move the cursor back to marker 1 and press **Marker Freq**. Turn the front panel knob while observing marker 1 on the 8757D.

On the 8757D, notice that the displayed amplitude and frequency values for marker 1 are relative to marker 0 as the marker moves along the trace. Refer to [Figure 2-5](#).

Figure 2-5 Delta Markers on 8757D

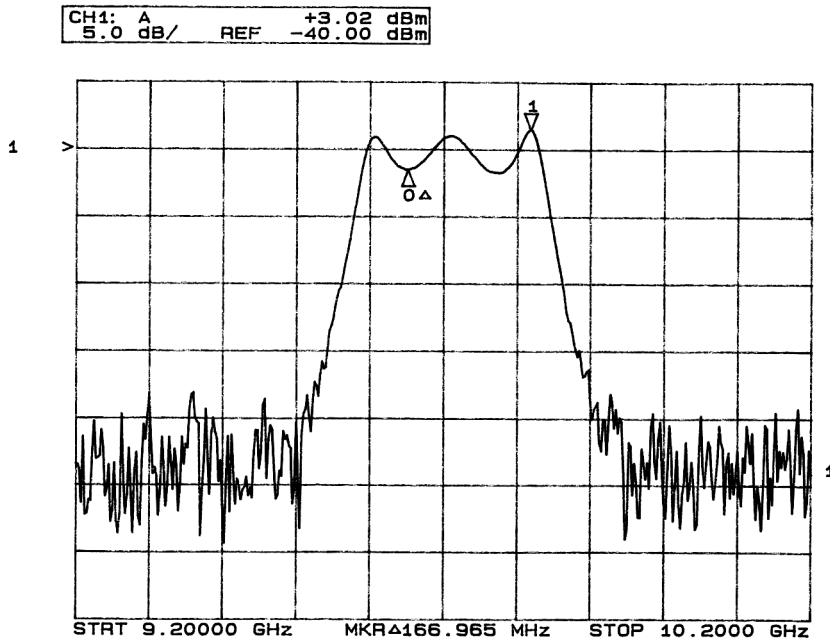

6. Press Turn Off Markers.

All active markers turn off. Refer to the *E8257D/67D PSG Signal Generators Key Reference* for information on other marker softkey functions.

Adjusting Sweep Time

1. Press Sweep/List.

This opens a menu of sweep control softkeys and displays a status screen summarizing all the current sweep settings.

2. Press Configure Ramp/Step Sweep.

Since ramp is the current sweep type, softkeys in this menu specifically control ramp sweep settings. When step is the selected sweep type, the softkeys control step sweep settings. Notice that the Freq Start and Freq Stop softkeys appear in this menu in addition to the Frequency hardkey menu.

3. Press Sweep Time to Manual > 5 > sec.

In auto mode, the sweep time automatically sets to the fastest allowable value. In manual mode, you can select any sweep time slower than the fastest allowable. The fastest allowable sweep time is dependent on the number of trace points and channels being used on the 8757D and the frequency span.

4. Press **Sweep Time** to Auto.

The sweep time returns to its fastest allowable setting.

NOTE When using an 8757 network analyzer in manual sweep mode, you must activate the signal generator's **Manual Freq** softkey before using the front panel knob to control the sweep. Press **Sweep/List > More (2 of 3) > Manual Freq**

Using Alternate Sweep

1. Press the **Save** hardkey.

This opens the table editor and softkey menu for saving instrument states. Notice that the **Select Reg** softkey is active. (For more information on saving instrument states refer to [“Using the Instrument State Registers” on page 53.](#))

2. Turn the front panel knob until you find an *available* register and press **SAVE**. Remember this saved register number. If no registers are available, you can write over an *in-use* register, by pressing **Re-SAVE**.

NOTE When you are using the PSG in a system with an 8757 network analyzer, you are limited to using registers 1 through 9 in sequence 0 for saving and recalling states.

3. Press **Sweep/List > Configure Ramp/Step Sweep** and enter new start and stop frequency values for the ramp sweep.
4. Press **Alternate Sweep Register** and turn the front panel knob to select the register number of the previously saved sweep state.
5. Press **Alternate Sweep Off On** to On.

The signal generator alternates between the original saved sweep and the current sweep. You may need to adjust 8757D settings to effectively view both sweeps, such as setting channel 2 to measure sensor A. Refer to [Figure 2-6](#).

Figure 2-6 Alternating Sweeps on 8757D

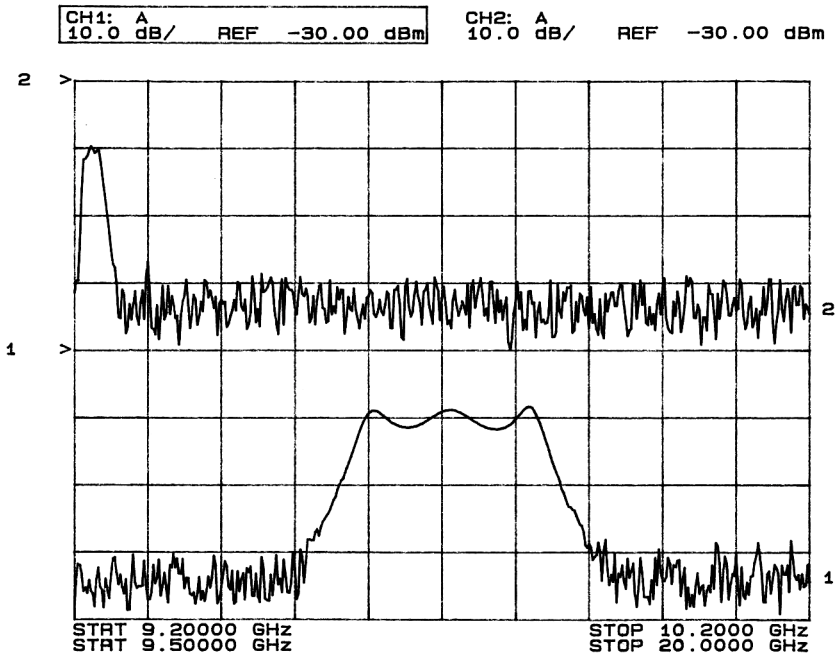

Configuring an Amplitude Sweep

1. Press Return > Sweep > Off.

This turns off both the current sweep and the alternate sweep from the previous task. The current CW settings now control the RF output.

2. Press Configure Ramp/Step Sweep.
3. Using the Ampl Start and Ampl Stop softkeys, set an amplitude range to be swept.
4. Press Return > Sweep > Ampl.

The new amplitude ramp sweep settings control the RF output and the CW mode is turned off.

Configuring a Ramp Sweep for a Master/Slave Setup

This procedure shows you how to configure two PSGs and an 8757D to work in a master/slave setup. The master/slave control setup must use two instruments from the same signal generator family such as two PSG's, or two 83640B's, or two 83751B's.

NOTE The master/slave setup applies to ramp sweep only, *not* step sweep or list sweep. To use this setup, you must have two sources from the same signal generator family such as two PSG's, or two 83640B's, or two 83751B's.

1. Set up the equipment as shown in [Figure 2-7](#). Use a 9-pin, D-subminiature, male RS-232 cable with the pin configuration shown in [Figure 2-8 on page 48](#) to connect the auxiliary interfaces of the two PSGs. You can also order the cable (part number 8120-8806) from Agilent Technologies.
By connecting the master PSG's 10 MHz reference standard to the slave PSG's 10 MHz reference input, the master's timebase supplies the frequency reference for both PSGs.
2. Set up the slave PSG's frequency and power settings.
By setting up the slave first, you avoid synchronization problems.
3. Set up the master PSG's frequency, power, and sweep time settings.
The two PSGs can have different frequency and power settings for ramp sweep.
4. Set the slave PSG's sweep time to match that of the master.
Sweep times must be the same for both PSGs.
5. Set the slave PSG to continuous triggering.
The slave must be set to continuous triggering, but the master can be set to any triggering mode.
6. On the slave PSG, press **Sweep/List > Sweep Type > Ramp Sweep Control > Slave**.
This sets the PSG to operate in slave mode.
7. On the master PSG, press **Sweep/List > Sweep Type > Ramp Sweep Control > Master**. This sets the PSG to operate in master mode.

Figure 2-7

Master/Slave Equipment Setup

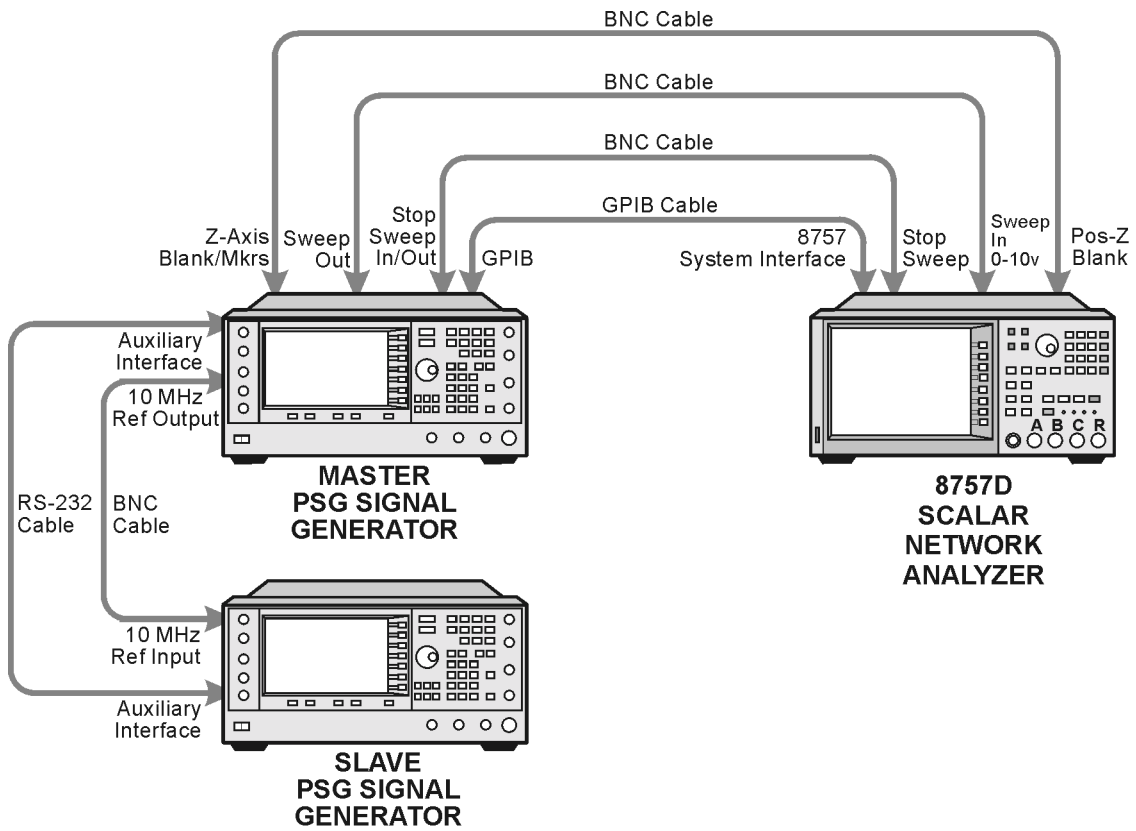
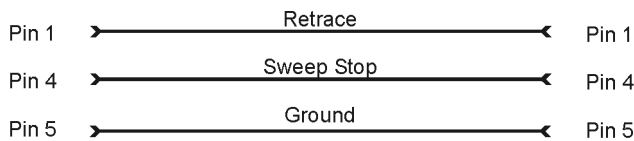

Figure 2-8

RS-232 Pin Configuration



Connector Type: D-Subminiature, male

pins145

Extending the Frequency Range

You can extend the signal generator frequency range using an Agilent 83550 series millimeter-wave source module or other manufacturer's mm-source module. Refer to [“Millimeter-Wave Source Modules” on page 230](#) for information on using the signal generator with a millimeter-wave source module.

Modulating a Signal

This section describes how to turn on a modulation format, and how to apply it to the RF output.

Turning On a Modulation Format

A modulation format can be turned on prior to or after setting the signal parameters.

1. Access the first menu within the modulation format.
This menu displays a softkey that associates the format's name with off and on. For example, **AM > AM Off On**. For some formats, the off/on key may appear in additional menus other than the first one.
2. Press the modulation format off/on key until On highlights.
[Figure 2-9](#) shows the portion of the AM modulation format's first menu that displays the state of the modulation format, as well as the active modulation format annunciator.

The modulation format generates, but the carrier signal is not modulated until you apply it to the RF output (see [page 50](#)).

Depending on the modulation format, the signal generator may require a few seconds to build the signal. Within the digital formats (E8267D PSG with Option 601/602 only), you may see a BaseBand Reconfiguring status bar appear on the display. Once the signal is generated, an annunciator showing the name of the format appears on the display, indicating that the modulation format is active. For digital formats (E8267D PSG with Option 601/602 only), the I/Q annunciator appears in addition to the name of the modulation format.

Figure 2-9 Example of AM Modulation Format Off and On

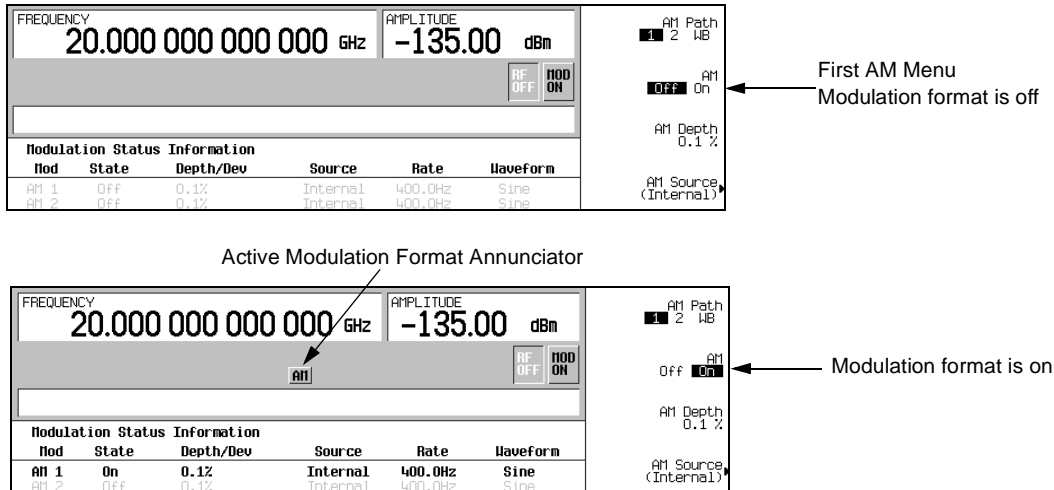

Applying a Modulation Format to the RF Output

The carrier signal is modulated when the Mod On/Off key is set to On, *and* an individual modulation format is active.

When the Mod On/Off key is set to Off, the MOD OFF annunciator appears on the display. When the key is set to On, the MOD ON annunciator shows in the display, whether or not there is an active modulation format. The annunciators simply indicate whether the carrier signal will be modulated when a modulation format is turned on.

To Turn RF Output Modulation On

Press the Mod On/Off key until the MOD ON annunciator appears in the display.

The carrier signal should be modulated with all active modulation formats. This is the factory default.

To Turn RF Output Modulation Off

Press the Mod On/Off key until the MOD OFF annunciator appears in the display.

The carrier signal is no longer modulated or capable of being modulated when a modulation format is active.

Figure 2-10 Carrier Signal Modulation Status

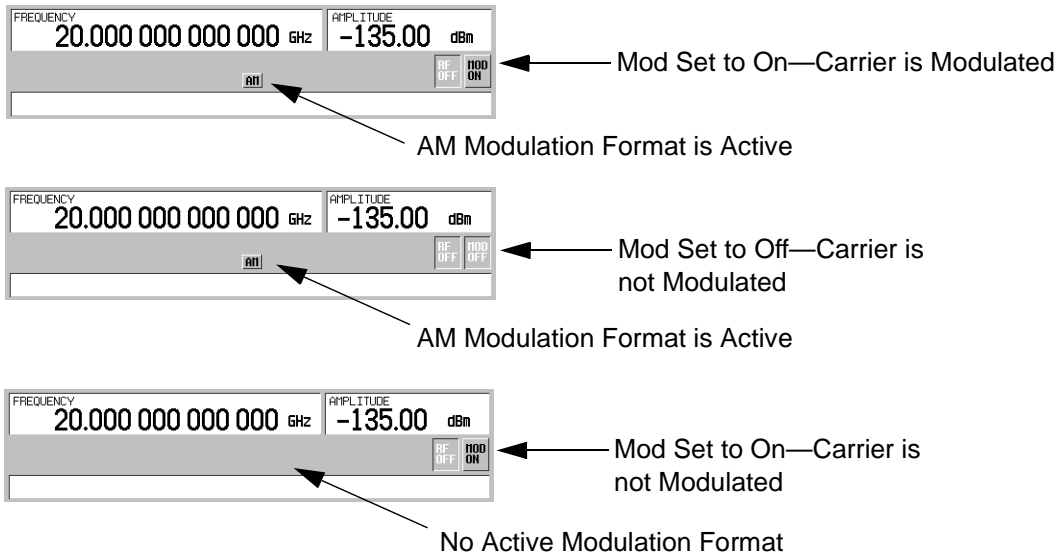

Using Data Storage Functions

This section explains how to use the two forms of signal generator data storage: the memory catalog and the instrument state register.

Using the Memory Catalog

The Memory Catalog is the signal generator's interface for viewing, storing, and saving files; it can be accessed through the signal generator's front panel or a remote controller. (For information on performing these tasks remotely, see the *E8257D/67D PSG Signal Generators Programming Guide*.)

Table 2-1 Memory Catalog File Types and Associated Data

Binary	binary data
State	instrument state data (controlling instrument operating parameters, such as frequency, amplitude, and mode)
LIST	sweep data from the List Mode Values table including frequency, amplitude, and dwell time
User Flatness	user flatness calibration correction pair data (user-defined frequency and corresponding amplitude correction values)
FIR	Finite Impulse Response (FIR) filter coefficients
ARB Catalog Types	(E8267D PSG with Option 601/602 only) user created files - Waveform Catalog Types: WFM1 (waveform file), NVARB Catalog Types: NVWFM (non-volatile, ARB waveform file), NVMKR (non-volatile, ARB waveform marker file), Seq (ARB sequence file), MTONE (ARB multitone file), DMOD (ARB digital modulation file), MDMOD (ARB multicarrier digital modulation file)
Modulation Catalog Types	(E8267D PSG with Option 601/602 only) associated data for I/Q and FSK (frequency shift keying) modulation files
Shape	burst shape of a pulse
Bit	Bit

Storing Files to the Memory Catalog

To store a file to the memory catalog, first create a file. For this example, use the default list sweep table.

1. Press **Preset**.
2. Press **Sweep/List > Configure List Sweep > More (1 of 2) > Load/Store**.

This opens the “Catalog of List Files”.

3. Press **Store to File**.

This displays a menu of alphabetical softkeys for naming the file. **Store to:** is displayed in the active function area.

4. Enter the file name **LIST1** using the alphabetical softkeys and the numeric keypad (for the numbers 0 to 9).
5. Press **Enter**.

The file should be displayed in the “Catalog of List Files”, showing the file name, file type, file size, and the date and time the file was modified.

Viewing Stored Files in the Memory Catalog

1. Press **Utility** > **Memory Catalog** > **Catalog Type**.

All files in the memory catalog are listed in alphabetical order, regardless of which catalog type you select. File information appears on the display and includes the file name, file type, file size, and the date and time the file was modified.

2. Press **List**.

The “Catalog of List Files” is displayed.

3. Press **Catalog Type** > **State**.

The “Catalog of State Files” is displayed.

4. Press **Catalog Type** > **All**.

The “Catalog of All Files” is displayed. For a complete list of file types, refer to [Table 2-1 on page 52](#).

Using the Instrument State Registers

The instrument state register is a section of memory divided into 10 sequences (numbered 0 through 9) with each sequence consisting of 100 registers (numbered 00 through 99). Instrument state sequences and registers are used to store and recall instrument settings and provide a quick way to reconfigure the signal generator when switching between different instrument and signal configurations. The signal generator with Option 005 (internal hard drive) has approximately 4 GB available for storing instrument state files and other user data. Without Option 005, the signal generator has 20 MB available for data and instrument state storage. Instrument state files can vary in length depending on the signal generator’s configuration.

File data, such as modulation formats, arb setups, and table entries, are not stored with the save function. Only setups such as frequency, attenuation, power and other user-defined settings that do not survive a power cycle or instrument reset can be saved to a sequence and register. Any data file, such as an arb format file, associated with the instrument state will only be referenced by its file name. Once an instrument state has been saved, recalling that state will setup the generator with the saved settings and load the associated file data.

For more information on storing file data such as modulation formats, arb setups, and table entries refer to [“Storing Files to the Memory Catalog” on page 52](#). Refer to the *E8257D/67D PSG Signal Generators Programming Guide* and the *E7257D/67D PSG Signal Generators Key Reference* for more information on the save and recall function.

NOTE A reference to a file is saved along with the instrument state. However, no data is saved with the save function. You must store file data, using store commands, in a different memory location.

Saving an Instrument State

1. Preset the signal generator, then turn on amplitude modulation (the **AM** annunciator will turn on):
 - a. Press **Frequency** > **800** > **MHz**.
 - b. Press **Amplitude** > **0** > **dBm**.
 - c. Press **AM** > **AM Off On**.

2. Press **Save > Select Seq.**

The sequence number becomes the active function. The signal generator displays the last sequence used. Using the arrow keys, set the sequence to 1.

3. Press **Select Reg.**

The register number in sequence 1 becomes the active function. The signal generator displays either the last register used accompanied by the text: (in use), or (if no registers are in use) register 00 accompanied by the text: (available). Use the arrow keys to select register 01.

4. Press **Save Seq[1] Reg[01].**

This saves this instrument state in sequence 1, register 01 of the instrument state register.

5. Press **Add Comment to Seq[1] Reg[01].**

This enables you to add a descriptive comment to sequence 1 register 01.

6. Using the alphanumeric softkeys or the knob, enter a comment and press **Enter.**

7. Press **Edit Comment In Seq[1] Reg[01].**

If you wish, you can now change the descriptive comment for sequence 1 register 01.

After making changes to an instrument state, you can save it back to a specific register by highlighting that register and pressing **Re-SAVE Seq[n] Reg[nn]**.

Recalling an Instrument State

Using this procedure, you will learn how to recall instrument settings saved to an instrument state register.

1. Press **Preset.**
2. Press the **Recall** hardkey.

Notice that the **Select Seq** softkey shows sequence 1. (This is the last sequence that you used.)

3. Press **RECALL Reg.**

The register to be recalled in sequence 1 becomes the active function. Press the up arrow key once to select register 1. Your stored instrument state settings should have been recalled.

Deleting Registers and Sequences

These procedures describe how to delete registers and sequences saved to an instrument state register.

Deleting a Specific Register within a Sequence

1. Press **Preset.**
2. Press the **Recall** or **Save** hardkey.
Notice that the **Select Seq** softkey shows the last sequence that you used.
3. Press **Select Seq** and enter the sequence number containing the register you want to delete.
4. Press **Select Reg** and enter the register number you want to delete.

Notice that the **Delete Seq[n] Reg[nn]** should be loaded with the sequence and register you want to

delete.

5. Press **Delete Seq[n] Reg[nn]**.

This deletes the chosen register.

Deleting All Registers within a Sequence

1. Press **Preset**.

2. Press the **Recall** or **Save** hardkey.

Notice that the **Select Seq** softkey shows the last sequence that you used.

3. Press **Select Seq** and enter the sequence number containing the registers you want to delete.
4. Press **Delete all Regs in Seq[n]**.

This deletes all registers in the selected sequence.

Deleting All Sequences

CAUTION Be sure you want to delete the contents of *all* registers and *all* sequences in the instrument state register.

1. Press **Preset**.

2. Press the **Recall** or **Save** hardkey.

Notice that the **Select Seq** softkey shows the last sequence that you used.

3. Press **Delete All Sequences**.

This deletes all of the sequences saved in the instrument state register.

8757 Network Analyzer Save and Recall Functions

The 8757 network analyzer family can save and recall signal generator instrument states although communication between the instruments is limited.

A clear register command from the 8757 will cause the signal generator to replace a register's contents with default values. Default values can be cleared from the signal generator by using the **Delete All** softkey menu or by using the corresponding SCPI (Standard Commands for Programmable Instruments) command.

The signal generator does not communicate directly with the 8757 network analyzer. If the 8757 saves an instrument state to a signal generator register and the user deletes that register, the 8757 will not recognize the deletion. An attempt, by the 8757, to recall a deleted state will cause the PSG to generate the error message: +700 "State Save Recall Error...".

Using Security Functions

This section describes how to use the PSG's security functions to protect and remove classified proprietary information stored or displayed in the instrument. All security functions described in this section also have an equivalent SCPI command for remote operation. (Refer to the "System Commands" chapter of the *E8257D/67D PSG Signal Generators SCPI Command Reference* for more information.)

Understanding PSG Memory Types

The PSG comprises several memory types, each used for storing a specific type of data. Before removing sensitive data, it is important to understand how each memory type is used in the PSG. The following tables describe each memory type used in the base instrument, optional baseband generator, and optional hard disk.

Table 2-2 Base Instrument Memory

Memory Type and Size	Writable During Normal Operation?	Data Retained When Powered Off?	Purpose/Contents	Data Input Method	Location in PSG and Remarks
Main Memory (SDRAM) 64 MB	Yes	No	firmware operating memory	operating system (not user)	CPU board
Main Memory (Flash) 20 MB	Yes	Yes	factory calibration/ configuration data user file system, which includes flatness calibration, IQ calibration, instrument states, waveforms (including header and marker data), modulation definitions, and sweep lists	firmware upgrades and user-saved data	CPU board (same chip as firmware memory, but managed separately) User data is not stored in this memory if hard disk (Option 005) is installed. Because this 32-MB memory chip contains 20 MB of user data (described here) and 12 MB of firmware memory, a full-chip erase is not desirable. User data areas are selectively and completely sanitized when you perform the Erase and Sanitize function.
Firmware Memory (Flash) 12 MB	No	Yes	main firmware image	factory installed or firmware upgrade	CPU board (same chip as main flash memory, but managed separately) During normal operation, this memory cannot be overwritten. It is only overwritten during the firmware installation or upgrade process. Because this 32-MB memory chip contains 20 MB of user data and 12 MB of firmware memory (described here), a full-chip erase is not desirable. User data areas are selectively and completely sanitized when you perform the Erase and Sanitize function.
Battery Backed Memory (SRAM) 512 kB	Yes	Yes	user-editable data (table editors) last instrument state and last instrument state backup user-stored instrument states	firmware operations	CPU board The battery can be removed to clear the memory, but must be reinstalled for the instrument to operate.

Table 2-2 Base Instrument Memory

Memory Type and Size	Writable During Normal Operation?	Data Retained When Powered Off?	Purpose/Contents	Data Input Method	Location in PSG and Remarks
Bootrom Memory (Flash) 128 kB	No	Yes	CPU bootup program and firmware loader/updater	factory programmed	CPU board During normal operation, this memory cannot be overwritten or erased. This read-only data is programmed at the factory.
Calibration Backup Memory (Flash) 512 KB	No	Yes	factory calibration/configuration data backup no user data	factory or service only	motherboard
Boards Memory (Flash) 512 Bytes	No	Yes	factory calibration and information files, code images, and self-test limits no user data	factory or service only	all RF boards, baseband generator, and motherboard
Micro-processor Cache (SRAM) 3 kB	Yes	No	CPU data and instruction cache	memory is managed by CPU, not user	CPU board

Table 2-3 Baseband Generator Memory (Options 601 and 602)

Memory Type and Size	Writable During Normal Operation?	Data Retained When Powered Off?	Purpose/Contents	Data Input Method	Remarks
Waveform Memory (SDRAM) 40–320 MB	Yes	No	waveforms (including header and marker data) and PRAM	normal user operation	User data is completely sanitized when you perform the Erase and Sanitize function.
BBG Firmware Memory (Flash) 32 MB	No	Yes	firmware image for baseband generator	firmware upgrade	
Coprocessor Memory (SRAM) 32 MB	Yes	No	operating memory of baseband coprocessor CPU	During normal operation, some user information, such as payload data, can remain in the memory.	This memory is used during normal baseband generator operation. It is not directly accessible by the user.

Table 2-3 Baseband Generator Memory (Options 601 and 602)

Memory Type and Size	Writable During Normal Operation?	Data Retained When Powered Off?	Purpose/Contents	Data Input Method	Remarks
Buffer Memory (SRAM) 5 x 512 kB	No	No	support buffer memory for ARB and real-time applications	normal user operation	This memory is used during normal baseband generator operation. It is not directly accessible by the user.

Table 2-4 Hard Disk Memory (Option 005)

Memory Type and Size	Writable During Normal Operation?	Data Retained When Powered Off?	Purpose/Contents	Data Input Method	Remarks
Media Storage (Built-in Hard Disk) 6 GB or 10 GB (4 GB usable in both cases)	Yes	Yes	user files, including flatness calibrations, IQ calibration, instrument states, waveforms (including header and marker data), modulation definitions, and sweep lists	user-saved data	The magnetic residue requires several rewrite cycles or drive removal and destruction. The hard disk is an option and is therefore not installed in some instruments. If it is installed, these files are stored on the hard disk instead of in flash memory. User data is completely sanitized when you perform the Erase and Sanitize function.
Buffer Memory (DRAM) 512 kB	No	No	buffer (cache) memory	normal operation through hard disk	

Removing Sensitive Data from PSG Memory

When moving the PSG from a secure development environment, you can remove any classified proprietary information stored in the instrument. This section describes several security functions you can use to remove sensitive data from your instrument.

Erase All

This function removes all user files, user flatness calibrations, user I/Q calibrations, and resets all table editors with original factory values, ensuring that user data and configurations are not accessible or viewable. The instrument appears as if it is in its original factory state, however, the memory is not sanitized. This action is relatively quick, taking less than one minute.

To carry out this function, press **Utility > Memory Catalog > More (1 of 2) > Security > Erase All > Confirm Erase**.

NOTE This function is different than pressing **Utility > Memory Catalog > More (1 of 2) > Delete All Files**, which deletes all user files, but does not reset the table editors.

Erase and Overwrite All

This function performs the same actions as **Erase All** and then clears and overwrites the various memory types in accordance with Department of Defense (DoD) standards, as described below.

SRAM – All addressable locations are overwritten with random characters.

CPU Flash – All addressable locations are overwritten with random characters and then the flash blocks are erased. This accomplishes the same purpose of a chip erase, however, only the areas that are no longer in use are erased and the factory calibration files are left intact.

DRAM – All addressable locations are overwritten with random characters.

Hard Disk – All addressable locations are overwritten with a single character. (This is insufficient for top secret data, according to DoD standards. For top secret data, the hard drive must be removed and destroyed.)

To carry out this function, press **Utility > Memory Catalog > More (1 of 2) > Security > Erase and Overwrite All > Confirm Overwrite**.

Erase and Sanitize All

This function performs the same actions as **Erase and Overwrite All** and then adds more overwriting actions. After executing this function, you must manually perform some additional steps for the sanitization to comply with Department of Defense (DoD) standards. These actions and steps are described below.

SRAM – After applying this function, the instrument must remain in the secure area long enough to ensure that the random overwriting resides in memory for a period longer than the classified data resided in memory. Alternatively, the SRAM battery can be removed then manually reinserted, however, this requires opening the instrument.

DRAM – All addressable locations are overwritten with a single character. You must then power off the instrument to purge the memory contents.

Hard Disk – All addressable locations are overwritten with a single character and then a random character. (This is insufficient for top secret data, according to DoD standards. For top secret data, the hard drive must be removed and destroyed.)

To carry out this function, press **Utility > Memory Catalog > More (1 of 2) > Security > Erase and Sanitize All > Confirm Sanitize**.

Using the Secure Mode

The secure mode automatically applies the selected **Security Level** action the next time the instrument's power is cycled.

To set the level of the secure mode, press **Utility > Memory Catalog > More (1 of 2) > Security > Security Level** and choose from the following selections:

None – equivalent to a factory preset, no user information is lost

Erase – equivalent to **Erase All**

Overwrite – equivalent to **Erase and Overwrite All**

Sanitize – equivalent to **Erase and Sanitize All**

To activate the secure mode, press **Utility > Memory Catalog > More (1 of 2) > Security > Enter Secure Mode > Confirm**. The **Enter Secure Mode** softkey changes to **Secure Mode Activated**.

CAUTION Once you select a security level action and activate secure mode by pressing **Confirm**, you cannot deactivate or decrease the security level. The erasure actions for that security level execute at the next power cycle. You can only increase the security level once the secure mode is activated. For example, you can change **Erase** to **Overwrite**, but not the reverse.

NOTE After the power cycle, the security level selection remains the same, but the secure mode is not activated.

If Your Instrument is Not Functioning

If the instrument is not functioning and you cannot use the security functions, the storage media must be physically removed from the instrument. This requires removal of the hard disk and processor board, which should then be rendered unusable and discarded. The instrument can then be sent to a repair facility for new parts, repair, and calibration. Refer to the *E8257D/67D PSG Signal Generators Service Guide* for disassembly procedures.

Using the Secure Display

This function prevents unauthorized personnel from reading the instrument display and tampering with the current configuration through the front panel. The display is blanked, except for the message ***** SECURE DISPLAY ACTIVATED *****, and the front panel keys are disabled. Once this function is activated, the power must be cycled to re-enable the display and front panel keys.

To apply this function, press **Utility > Display > More (1 of 2) > Activate Secure Display > Confirm Secure Display**

Figure 2-11 PSG Screen with Secure Display Activated

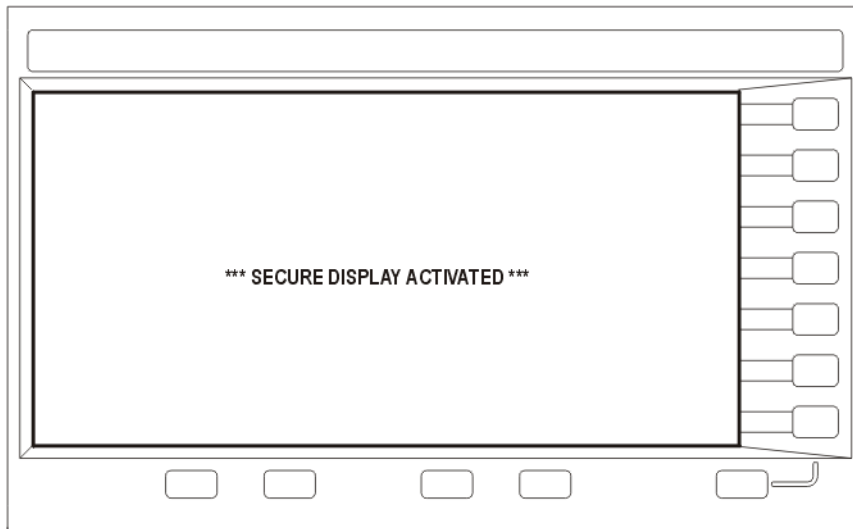

Enabling Options

You can retrofit your signal generator after purchase to add new capabilities. Some new optional features are implemented in hardware that you must install. Some options are implemented in software, but require the presence of optional hardware in the instrument. This example shows you how to enable software options.

Enabling a Software Option

A license key (provided on the license key certificate) is required to enable each software option.

1. Access the Software Options menu:
Utility > Instrument Adjustments > Instrument Options > Software Options.

The following is an example of the signal generator display, which lists any enabled software options, and any software options that can be enabled:

FREQUENCY 20.000 000 000 000 GHz		AMPLITUDE -135.00 dBm		Modify License Key
<input type="button" value="EXT REF"/>		<input type="button" value="RF OFF"/> <input type="button" value="MOD ON"/>		
Software Option Selection				Host ID = e177ffff
Option License Key	Description			<input type="button" value="Proceed With Reconfiguration"/>
007 FB463FA17214	✓ RAMP SWEEP			
015 00000000000A	✓ WIDEBAND IQ			
1EA	✓ HIGH OUTPUT POWER			
420	✓ RADAR SIMULATION PERSONALITY			
421	✓ NOISE POWER RATIO PERSONALITY			

2. Verify that the host ID shown on the display matches the host ID on the license key certificate. The host ID is a unique number for every instrument. If the host ID on the license key certificate does not match your instrument, the license key cannot enable the software option.
3. Verify that any required hardware is installed. Because some software options are linked to specific hardware options, before the software option can be enabled, the appropriate hardware option must be installed. For example, Option 420 (radar simulation modulation format) requires that Option 601/602 (internal baseband generator) be installed. If the software option that you intend to install is listed in a grey font, the required hardware may not be installed (look for an X in the “Selected” column of the appropriate hardware option in the Hardware Options menu).
4. Enable the software option:
 - a. Highlight the desired option.
 - b. Press **Modify License Key**, and enter the 12-character license key (from the license key certificate).
 - c. Verify that you want to reconfigure the signal generator with the new option:
Proceed With Reconfiguration > Confirm Change
The instrument enables the option and reboots.

Using the Web Server

You can communicate with the signal generator using the Web Server. This service uses TCP/IP (Transmission Control Protocol/Internet Protocol) to communicate with the signal generator over the internet.

The Web Server uses a client/server model where the client is the web browser on your PC or workstation and the server is the signal generator. When you enable the Web Server, you can access a web page that resides on the signal generator.

The Web-Enabled PSG web page, shown in [Figure 2-12](#), provides general information on your signal generator and a means to control the instrument by using a remote front-panel interface or using SCPI (Standard Communication for Programmable Instruments) commands. The web page also has links to Agilent's products, support, manuals, and website.

NOTE The Web Server service is compatible with the latest version of the Microsoft© Internet Explorer web browser.¹

The Signal Generator Web Control menu button on the Web-Enabled PSG web page will access a second web page. This web page, shown in [Figure 2-13](#), provides a virtual instrument interface that can be used to control the signal generator. You can use the mouse to click on the signal generator's front panel hardkeys, softkeys and number pad. There is also a text box that can be used to send SCPI commands to the instrument.

Activating the Web Server

Perform the following steps to access the Web Server.

1. Turn on the Web Server by pressing **Utility > GPIB/RS-232 LAN > LAN Services Setup > Web Server On**.
2. Press the **Proceed With Reconfiguration** softkey.
3. Press the **Confirm Change (Instrument will Reboot)** softkey. The signal generator will reboot.
4. Launch your PC or workstation web browser.
5. Enter the IP address of the signal generator in the web browser address field. For example, <http://101.101.101.101>. Replace 101.101.101.101 with your signal generator's IP address. Press the Enter key on the computer's keyboard.

NOTE The IP (Internet Protocol) address can change depending on your LAN configuration. Use the **LAN Config Manual DHCP** softkey to select a Manual or DHCP (dynamic host communication protocol) LAN configuration. Refer to *E8257D/67D PSG Signal Generators Key Reference* for more information.

6. Press the enter key on the computer's keyboard. The web browser will display the signal generator's homepage as shown below in [Figure 2-12](#). This web page displays information about the signal generator and provides access to Agilent's website.

1. Microsoft is a registered trademark of Microsoft Corp.

Figure 2-12 Signal Generator Web Page

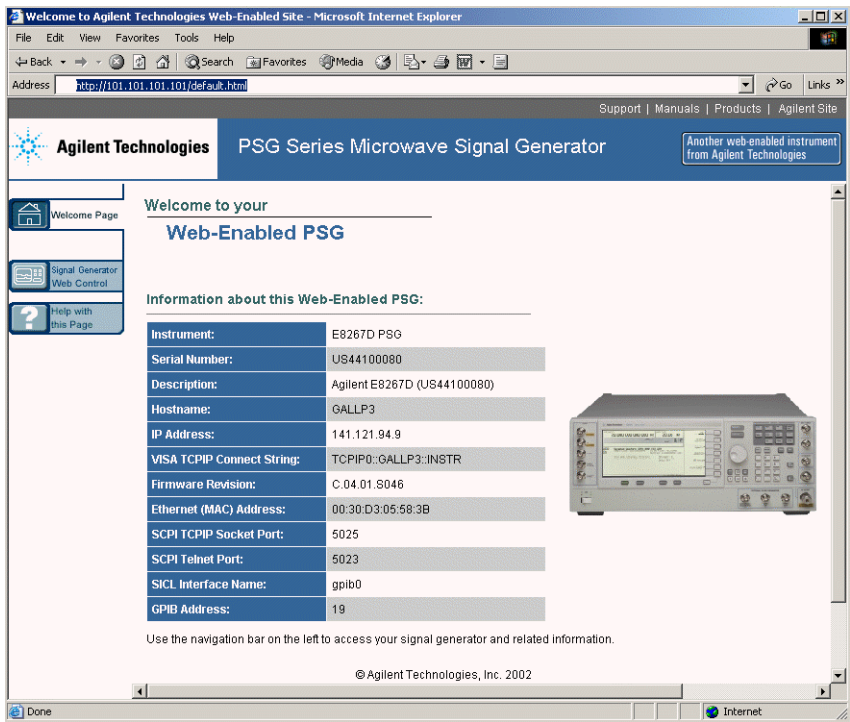

- Click the Signal Generator Web Control menu button on the left of the page. A new web page will be displayed as shown below in Figure 2-13.

Figure 2-13 Web Page Front Panel

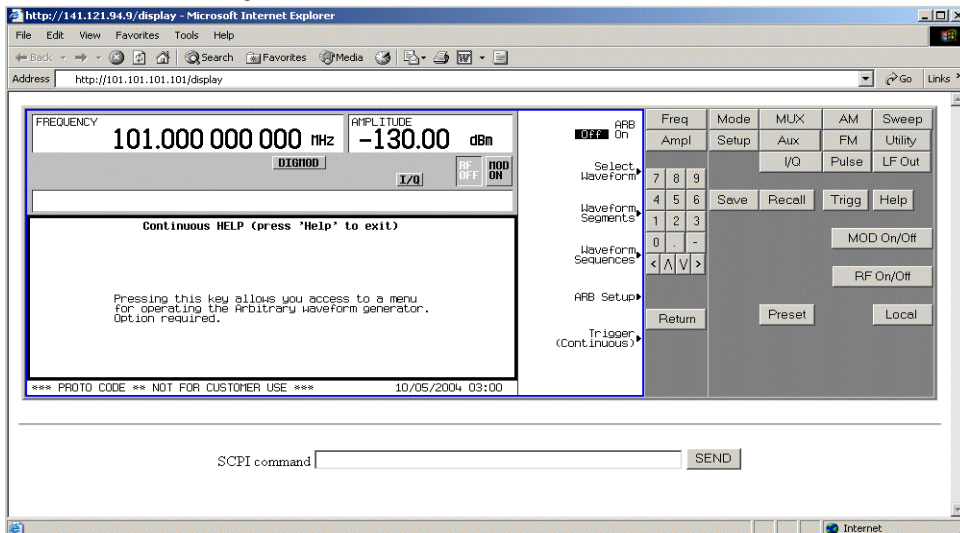

This web page remotely accesses all signal generator functions and operations. Use the mouse pointer to click on the signal generator’s hardkeys and softkeys. The results of each mouse click selection will be displayed on the web page. For example, click on the Frequency hardkey then use the front-panel key pad to enter a frequency. You can also use the up and down arrow keys to increase or decrease the frequency.

You can use the SCPI Command text box at the bottom of the front-panel display to send commands to the signal generator. Enter a valid SCPI command, then click the SEND button. The results of the command will be displayed on a separate web page titled, “SCPI Command Processed”. You can continue using this web page to enter SCPI commands or you can return to the front panel web page.

NOTE It may be necessary to use the web browser Refresh function if the web page does not update with new settings.

3 Basic Digital Operation

This chapter provides information on the functions and features available for the E8267D PSG vector signal generator with Option 601 or 602.

- [“Custom Modulation” on page 67](#)
- [“Arbitrary \(ARB\) Waveform File Headers” on page 68](#)
- [“Using the Dual ARB Waveform Player” on page 79](#)
- [“Using Waveform Markers” on page 84](#)
- [“Triggering Waveforms” on page 98](#)
- [“Using Waveform Clipping” on page 104](#)
- [“Using Waveform Scaling” on page 112](#)

See also:

- [“Custom Arb Waveform Generator” on page 137](#)
- [“Multitone Waveform Generator” on page 179](#)
- [“Two-Tone Waveform Generator” on page 189](#)

Custom Modulation

For creating custom modulation, the signal generator offers two modes of operation: the Arb Waveform Generator mode and the Real Time I/Q Baseband mode. The Arb Waveform Generator mode has built-in modulation formats such as NADC or GSM and pre-defined modulation types such as BPSK and 16QAM that can be used to create a signal. The Real Time I/Q Baseband mode can be used to create custom data formats using built-in PN sequences or custom-user files along with various modulation types and different built-in filters such as Gaussian or Nyquist.

Both modes of operation are used to build complex, digitally modulated signals that simulate communication standards with the flexibility to modify existing digital formats, define or create digitally modulated signals, and add signal impairments.

Custom Arb Waveform Generator

The signal generator's Arb Waveform Generator mode is designed for out-of-channel test applications. This mode can be used to generate data formats that simulate random communication traffic and can be used as a stimulus for component testing. Other capabilities of the Arb Waveform Generator mode include:

- configuring single or multicarrier signals. Up to 100 carriers can be configured.
- creating waveform files using the signal generator's front panel interface.

The waveform files, when created as random data, can be used as a stimulus for component testing where device performance such as adjacent channel power (ACP) can be measured. The AUTOGEN_WAVEFORM file that is automatically created when you turn the Arb Waveform Generator on can be renamed and stored in the signal generator's non-volatile memory. This file can later be loaded into volatile memory and played using the Dual ARB waveform player.

For more information, refer to the sections [“Using the Dual ARB Waveform Player” on page 79](#) and [“Modes of Operation” on page 5](#).

Custom Real Time I/Q Baseband

The real-time mode simulates single-channel communication using user-defined modulation types along with custom FIR filters, and symbol rates. Data can be downloaded from an external source into PRAM memory or supplied as real time data using an external input. The Real Time I/Q Baseband mode can also generate pre-defined data formats such as PN9 or FIX4. A continuous data stream generated in this mode can be used for receiver bit error analysis. This mode is limited to a single carrier. The Real Time I/Q Baseband mode:

- has more data and modulation types available than the Arb Waveform Generator mode.
- supports custom I/Q constellation formats.
- has the capability to generate continuous PN sequences for bit error rate testing (BERT).
- needs no waveform build time when signal parameters are changed.

For more information, refer to the custom arb section [“Overview” on page 137](#), the custom real time section [“Overview” on page 159](#) and the section on [“Digital Modulation” on page 6](#).

Arbitrary (ARB) Waveform File Headers

An ARB waveform file header enables you to save instrument setup information (key format settings) along with a waveform. When you retrieve a stored waveform, the header information is applied so that when the waveform starts playing, the dual ARB player is set up the same way each time.

Headers can also store a user-specified 32-character description of the waveform or sequence file.

A default header is automatically created whenever a waveform is generated, a waveform sequence is created, or a waveform file is downloaded to the PSG (for details on downloading files, see the *E8257D/67D PSG Signal Generators Programming Guide*).

The following signal generator settings are saved in a file header:

- ARB sample clock rate
- Runtime scaling (only in the dual ARB player)

Marker settings and routing functions (page 84)

- Polarity
- ALC hold
- RF blanking
- High crest mode (only in the dual ARB player)
- Modulator attenuation
- Modulator filter
- I/Q output filter (used when routing signals to the rear panel I/Q outputs)
- Other instrument optimization settings (for files generated by the PSG) that cannot be set by the user.

Creating a File Header for a Modulation Format Waveform

When you turn on a modulation format, the PSG generates a temporary waveform file (AUTOGEN_WAVEFORM), with a default file header. The default header has no signal generator settings saved to it.

This procedure, which is the same for all ARB formats, demonstrates how to create a file header for a Custom digital modulation format.

1. Preset the signal generator.
2. Turn on the Custom modulation format:
Press **Mode** > **Custom** > **ARB Waveform Generator** > **Digital Modulation Off On** to **On**

A default file header is created, and the temporary waveform file (AUTOGEN_WAVEFORM) plays. Figure 3-1 shows the PSG's display.

Figure 3-1 Custom Digital Modulation First-Level Softkey Menu

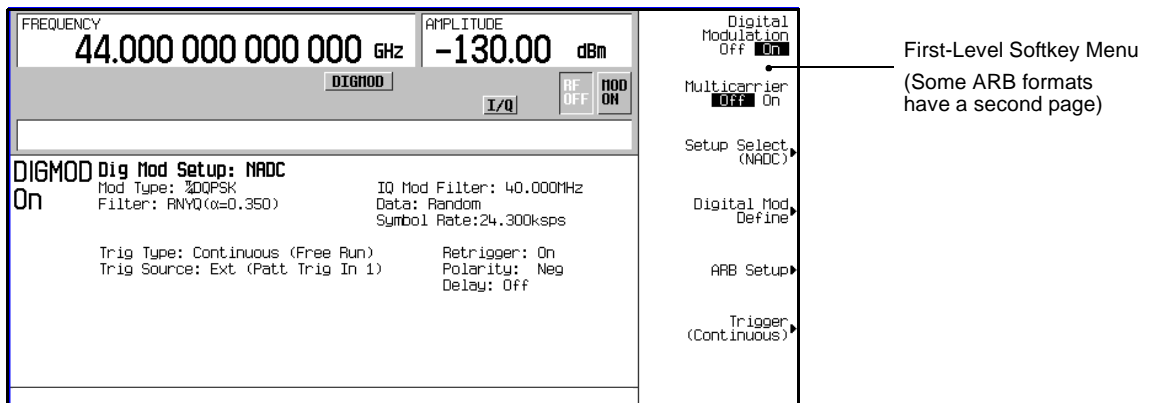

At this point, a default file header has been created, with default (unspecified) settings that do not reflect the current signal generator settings for the active modulation. To save the settings for

the active modulation, you must modify the default settings before you save the header information with the waveform file (see [“Modifying Header Information in a Modulation Format” on page 70](#)).

NOTE Each time an ARB modulation format is turned on, a new temporary waveform file (AUTOGEN_WAVEFORM) and file header are generated, overwriting the previous temporary file and file header. Because all ARB formats use the same file name, this happens even if the previous AUTOGEN_WAVEFORM file was created by a different ARB modulation format.

Modifying Header Information in a Modulation Format

This procedure builds on the previous procedure, explaining the different areas of a file header, and showing how to access, modify, and save changes to the information.

In a modulation format, you can access a file header only while the modulation format is active (on). This procedure uses the Custom digital modulation format. All ARB modulation formats and the dual ARB player access the file header the same way, except that in some modulation formats, you may have to go to page two of the first-level softkey menu.

1. From the first-level softkey menu (shown in [Figure 3-1 on page 69](#)), open the Header Utilities menu:
Press **ARB Setup > Header Utilities**

[Figure 3-2](#) shows the default header for the Custom digital modulation waveform. The **Saved Header Settings** column, shows that the signal generator settings for the active format are **Unspecified**, which means that no settings have been saved to the file header.

NOTE If a setting is unspecified in the file header, the signal generator’s current value for that setting does not change when you select and play the waveform in the future.

The **Current Inst. Settings** column shows the current signal generator settings for the active modulation. These settings become the saved header settings when they are saved to the file header (as demonstrated in [Step 2](#)).

Figure 3-2 Custom Digital Modulation Default Header Display

Let's you enter/edit the Description field

Clears the Saved Header Settings column to the default settings

Saves the Current Inst. Settings column to the Saved Header Settings column

Current signal generator settings

Note: Parameters that are inactive (such as Runtime Scaling) can be set only in the dual ARB player.

Description	Saved Header Settings	Current Inst. Settings
Sample Rate	Unspecified	97.2000 kHz
Runtime Scaling	Unspecified	92.00 %
Marker 1 Polarity	Unspecified	Pos
Marker 2 Polarity	Unspecified	Pos
Marker 3 Polarity	Unspecified	Pos
Marker 4 Polarity	Unspecified	Pos
ALC Hold Routing	Unspecified	None
Alt Ampl. Routing	Unspecified	None
RF Blank Routing	Unspecified	None
High Crest Mode	Unspecified	Off
Mod Attenuation	Unspecified	Auto
I/Q Mod Filter	Unspecified	Auto
I/Q Output Filter	Unspecified	Auto

- Save the information in the Current Inst. Settings column to the file header:
Press **Save Setup To Header**.

Both the Saved Header Settings column and the Current Inst. Settings column now display the same settings; the Saved Header Settings column lists the settings saved in the file header.

The file header contains the following signal generator settings:

32-Character Description:	A description entered for the header, such as a the waveform's function (saved/edited with the Edit Description key, see Figure 3-2 on page 71).
Sample Rate:	The ARB sample clock rate.
Runtime Scaling:	The Runtime scaling value. Runtime scaling is applied in real-time while the waveform is playing. This setting can be changed only for files in the dual ARB player.
Marker 1...4 Polarity:	The marker polarity, positive or negative (described on page 98).
ALC Hold Routing:	Which marker, if any, implements the PSG's ALC hold function (described on page 86).
RF Blank Routing:	Which marker, if any, implements the PSG's RF blanking function (described on page 96).
I/Q Mod Filter:	The I/Q modulator filter setting. The modulator filter affects the I/Q signal modulated onto the RF carrier.
I/Q Output Filter:	The I/Q output filter setting. The I/Q output filter is used for I/Q signals routed to the rear panel I and Q outputs.
Mod Attenuation:	The I/Q modulator attenuation setting.

3. Return to the ARB Setup menu: Press **Return**.

In the ARB Setup menu (shown in [Figure 3-3](#)), you can change the current instrument settings. [Figure 3-3](#) also shows the softkey paths used in steps four through nine.

4. Set the ARB sample clock to 5 MHz: Press **ARB Sample Clock > 5 > MHz**.
5. Set the modulator attenuation to 15 dB:
Press **More (1 of 2) > Modulator Atten n.nn dB Manual Auto to Manual > 15 > dB**.
6. Set the I/Q modulation filter to a through:
Press **I/Q Mod Filter Manual Auto to Manual > Through**.
7. Set marker one to blank the RF output at the set marker point(s):
Press **More (2 of 2) > Marker Utilities > Marker Routing > Pulse/RF Blank > Marker 1**.

For information on setting markers, see [“Using Waveform Markers” on page 84](#).

8. Set the polarity of Marker 1 negative:
Press **Return > Marker Polarity > Marker 1 Polarity Neg Pos to Neg**.
9. Return to the Header Utilities menu: Press **Return > Return > Header Utilities**.

Notice that the **Current Inst. Settings** column now reflects the changes made to the current signal generator setup in steps 4 through 8, but that the saved header values have not changed (as shown in [Figure 3-4 on page 74](#)).

10. Save the current settings to the file header: Press **Save Setup To Header** softkey.

The settings from the **Current Inst. Settings** column now appear in the **Saved Header Settings** column. The file header has been modified and the current instrument settings saved. This is shown in [Figure 3-5 on page 74](#).

While a modulation format is active (is on), the waveform file (AUTOGEN_WAVEFORM) plays and you can modify the header information within the active modulation format. Once you turn the modulation format off, the header information is available only through the dual ARB player.

NOTE If you turn the modulation format off and then on, you overwrite the previous AUTOGEN_WAVEFORM file and its file header. To avoid this, rename the file before you turn the modulation format back on (see [page 84](#)).

Storing a waveform file (see [page 83](#)) stores the *saved* header information with the waveform.

Figure 3-3 ARB Setup Softkey Menu and Marker Utilities

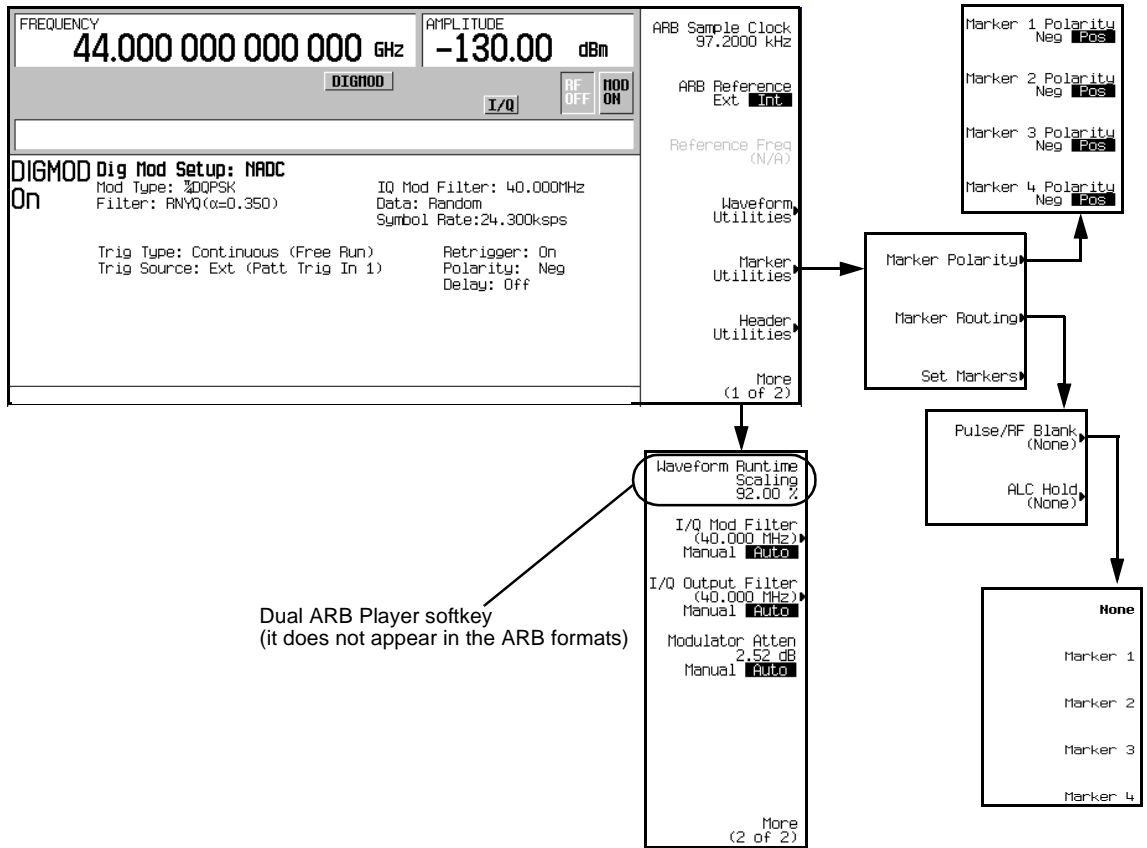

Figure 3-4 Differing Values between Header and Current Setting Columns

The screenshot shows a software interface with the following sections:

- Top Panel:** FREQUENCY: 44.000 000 000 000 GHz, AMPLITUDE: -130.00 dBm. Includes buttons for DIGMOD, ENULP, I/Q, RF OFF, and MOD ON.
- File Header Information:** UFM1:AUTOGEN_JIAVEFORM
- Table 1 (Page 1):**

Header Field	Saved Header Settings	Current Inst. Settings
Description		
Sample Rate	Unspecified	5.0000000 MHz
Runtime Scaling	Unspecified	92.00 %
Marker 1 Polarity	Unspecified	Neg
Marker 2 Polarity	Unspecified	Pos
Marker 3 Polarity	Unspecified	Pos
Marker 4 Polarity	Unspecified	Pos
ALC Hold Routing	Unspecified	None
Alt Ampl. Routing	Unspecified	None
- Table 2 (Page 2):**

RF Blank Routing	Unspecified	Marker 1
High Crest Mode	Unspecified	Off
Mod Attenuation	Unspecified	15.00 dB
I/Q Mod Filter	Unspecified	Through
I/Q Output Filter	Unspecified	Auto

Annotations indicate that values differ between the 'Saved Header Settings' and 'Current Inst. Settings' columns for several parameters, including Sample Rate, Runtime Scaling, Marker 1 Polarity, and Mod Attenuation.

Figure 3-5 Saved File Header Changes

The screenshot shows the same software interface as Figure 3-4, but with the 'Saved Header Settings' column updated to match the 'Current Inst. Settings' column:

- Table 1 (Page 1):**

Header Field	Saved Header Settings	Current Inst. Settings
Description		
Sample Rate	5.0000 MHz	5.0000000 MHz
Runtime Scaling	92.00 %	92.00 %
Marker 1 Polarity	Negative	Neg
Marker 2 Polarity	Positive	Pos
Marker 3 Polarity	Positive	Pos
Marker 4 Polarity	Positive	Pos
ALC Hold Routing	None	None
Alt Ampl. Routing	None	None
- Table 2 (Page 2):**

RF Blank Routing	Marker 1	Marker 1
High Crest Mode	Off	Off
Mod Attenuation	15.000 dB	15.00 dB
I/Q Mod Filter	Through	Through
I/Q Output Filter	Auto	Auto

Annotations indicate that the 'Saved Header Settings' column now matches the 'Current Inst. Settings' column for all parameters.

Storing Header Information for a Dual ARB Player Waveform Sequence

When you create a waveform sequence (described on [page 81](#)), the PSG automatically creates a default file header, which takes priority over the headers for the waveform segments that compose the waveform sequence. During a waveform sequence playback, the waveform segment headers are ignored (except to verify that all required options are installed). When you store the waveform sequence, its file header is stored with it.

Modifying and Viewing Header Information in the Dual ARB Player

Once a modulation format is turned off, the waveform file is available only to the dual ARB player. This is also true for downloaded waveform files. Because of this, future edits to a waveform's header information must be performed using the dual ARB player.

To modify header information in the dual ARB player, the waveform file must be playing in the dual ARB player (although you can *view* the header information in the dual ARB player without playing the file)

You can reapply saved header settings by reselecting the waveform file for playback. When you do this, the values from the *Saved Header Settings* column are applied to the PSG.

Modifying Header Information

All of the same header characteristics shown in “[Modifying Header Information in a Modulation Format](#)” on [page 70](#) are valid in the dual ARB player. This task guides you through selecting a waveform file and accessing the header for the selected file, then refers you back to the aforementioned procedure to perform the modifications.

1. Select a waveform:
 - a. Press **Mode > Dual ARB > Select Waveform**.
 - b. Using the arrow keys, highlight the desired waveform file.
 - c. Press the **Select Waveform** softkey.
2. Play the waveform: Press **ARB Off On** to On.
3. Access the header: Press **ARB Setup > Header Utilities**.
4. Refer to “[Modifying Header Information in a Modulation Format](#)” to edit the header information:
 - For a default header, read the information in step one on [page 70](#), then perform the remaining steps in the procedure.
 - To modify an existing file header, start with step three on [page 72](#).

The rest of this section focuses on the additional file header operations found in the dual ARB player.

Viewing Header Information with the Dual ARB Player Off

One of the differences between a modulation format and the dual ARB player is that even when the dual ARB player is off, you can view a file header. You cannot, however, modify the displayed file header unless the dual ARB player is on, *and* the displayed header is selected for playback. With the dual ARB player off, perform the following steps.

1. Select a waveform:
 - a. Press **Mode** > **Dual ARB** > **Select Waveform**.
 - b. Highlight the desired waveform file.
 - c. Press the **Select Waveform** softkey.
2. Access the file header: Press **ARB Setup** > **Header Utilities**.
The header information is now visible in the PSG display. As shown in [Figure 3-6](#), the header editing softkeys are grayed-out.

Figure 3-6 Viewing Header Information

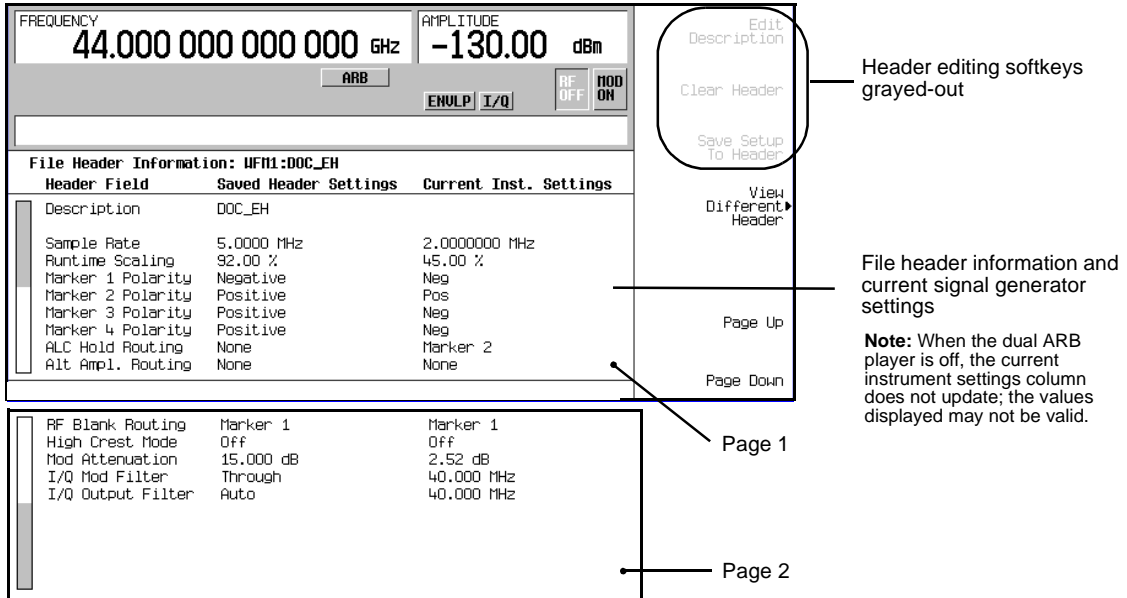

Viewing Header Information for a Different Waveform File

While a waveform is playing in the dual ARB player, you can view the header information of a different waveform file, but you can modify the header information only for the waveform that is currently playing. When you select another waveform file, the header editing softkeys are grayed-out (see Figure 3-6). This task guides you through the available viewing choices.

1. View the waveform file list: Press **Mode** > **Dual ARB** > **ARB Setup** > **Header Utilities** > **View Different Header**.

As shown in Figure 3-7, there is an alphabetical list of waveform files in the table.

Figure 3-7 Waveform File List for Viewing a Different Header

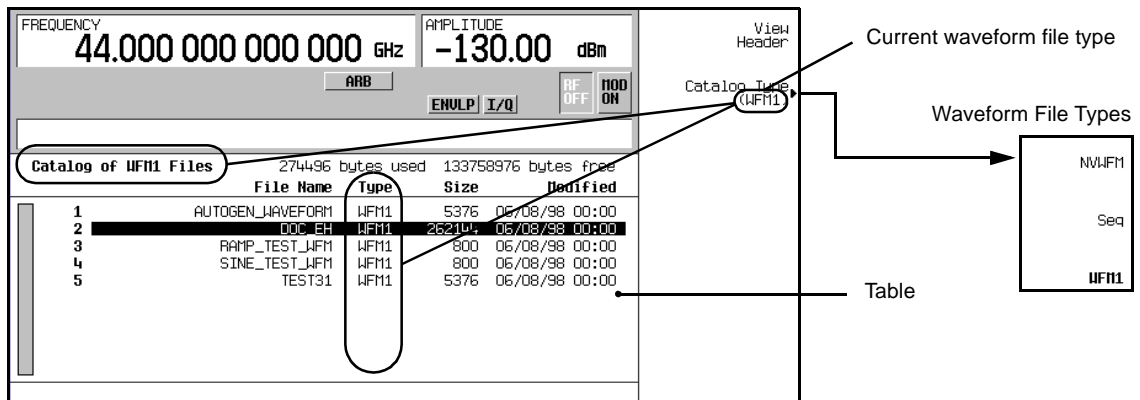

2. View all waveform segments in non-volatile memory:
 - a. Press the **Catalog Type** softkey. As shown in Figure 3-7, you have a choice of three waveform file types that can be displayed in the table accessed in step one.
 - NVWFM** displays all waveform segments stored in non-volatile memory
 - Seq** displays all waveform sequence files
 - WFM1** displays all waveform segments stored in volatile memory
 - b. Press the **NVWFM** softkey. The table displays the waveform files in non-volatile memory.
3. View a waveform file's header information: Highlight a file and press the **View Header** softkey.

The header information for the selected waveform file appears in the PSG display. If there is a waveform playing, its header information is replaced by this information, but the waveform settings used by the signal generator do *not* change. To return to the header information for the playing waveform, either press **View Different Header**, select the current playing waveform file, and press **View Header**, or press **Return** > **Header Utilities**.

Playing a Waveform File that Contains a Header

After a waveform file (AUTOGEN_WAVEFORM) is generated in a modulation format and the format is turned off, the file becomes accessible to and can only be played back by the dual ARB player. This is true for downloaded waveform files (downloading files is described in the *E8257D/67D PSG Signal Generators Programming Guide*). When the waveform is selected for playback, the saved header information is used by the signal generator. Some of these settings appear as part of the labels of the softkeys used to set the parameters, and also appear on the dual ARB summary display (see [Figure 3-8](#)).

NOTE The signal generator used to play back a stored waveform file must have the same options as are required to generate the file.

For details on applying file header settings and playing back a waveform, see [“Playing a Waveform” on page 82](#).

To properly set up the instrument:

1. Select the waveform.
2. Modify the signal generator settings as desired.
3. Turn on the dual ARB.

Figure 3-8 File Header Settings

The figure consists of two screenshots of the File Header Settings interface, illustrating the state of the instrument when a waveform is not selected versus when it is selected.

Top Screenshot (Waveform not selected):

- FREQUENCY:** 44.000 000 000 000 GHz
- AMPLITUDE:** -130.00 dBm
- RF OFF / MOD ON** buttons are visible.
- Selected Waveform:** #NONE*
- Sample Clock:** 100.000000MHz
- IQ Mod Filter:** Through
- Ref Freq:** 10.000000MHz (Int)
- Trig Type:** Continuous (Free Run)
- Trig Source:** Ext (Patt Trig In 1)
- Retrigger:** On
- Polarity:** Neg
- Delay:** Off
- Summary Display:** Shows the current settings.
- Annotations:**
 - Pulse/RF Blank (None):** Can change when a waveform is selected.
 - ALC Hold (None):** Header setting same as preset setting.

Bottom Screenshot (Waveform selected):

- FREQUENCY:** 44.000 000 000 000 GHz
- AMPLITUDE:** -130.00 dBm
- RF OFF / MOD ON** buttons are visible.
- Selected Waveform:** WFM1:TEST31
- Sample Clock:** 5.000000MHz
- IQ Mod Filter:** 40.000MHz
- Ref Freq:** 10.000000MHz (Int)
- Trig Type:** Continuous (Free Run)
- Trig Source:** Ext (Patt Trig In 1)
- Retrigger:** On
- Polarity:** Neg
- Delay:** Off
- Summary Display:** Shows the current settings.
- Annotations:**
 - Pulse/RF Blank (None):** Header setting same as preset setting.
 - ALC Hold (Marker 2):** Header setting applied.

Using the Dual ARB Waveform Player

The dual arbitrary (ARB) waveform player is used to create, edit, and play waveform files. There are two types of waveform files: segments and sequences. A segment is a waveform file that is created using one of the signal generator's pre-defined ARB formats. A sequence can be described as several segments strung together to create one waveform file. Waveform files can also be created remotely using another signal generator or using computer programs and downloaded to the PSG for playback by the Dual ARB waveform player. For information on downloading waveforms, refer to the *E8257D/67D PSG Signal Generators Programming Guide*.

A waveform file is automatically generated whenever an ARB modulation format is turned on. This automatically generated file is named AUTOGEN_WAVEFORM. Because this default file name is shared among all ARB formats, it must be renamed if you want to save the information. If the file is not renamed, it will be overwritten when another ARB format is turned on.

The Dual ARB waveform player provides markers ([page 84](#)), triggering ([page 98](#)), and clipping ([page 104](#)) capabilities.

Before you can work with any waveform file, it must reside in volatile memory. The signal generator has two types of memory, WFM1 (volatile waveform memory) and NVWFM (non-volatile waveform memory). A newly generated waveform file (AUTOGEN_WAVEFORM), created when the Arb Waveform Generator is turned on, initially resides in WFM1. If you want to save this file, rename it and store it in NVWFM. Load a stored waveform file from NVWFM into volatile memory (WFM1) where it can be edited or played by the ARB waveform player. Refer to “[Custom Modulation](#)” on [page 67](#) for more information.

Accessing the Dual ARB Player

Press **Mode > Dual ARB**.

his first-level softkey menu is shown in the following figure. Most procedures start from this menu.

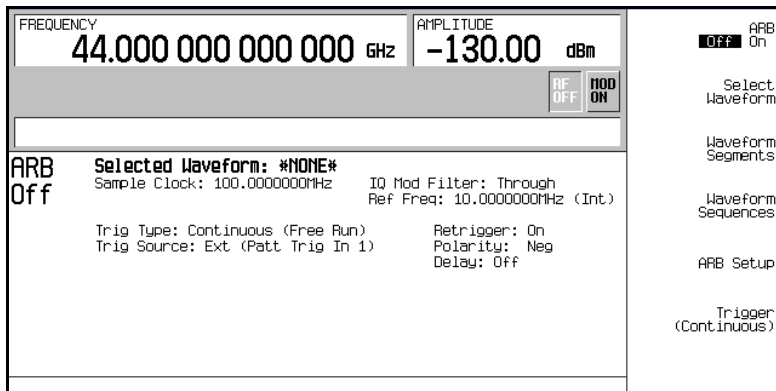

Creating Waveform Segments

There are two ways to provide waveform segments for use by the waveform sequencer. You can either download a waveform via the remote interface, or generate a waveform using one of the ARB modulation formats. For information on downloading waveforms via the remote interface, see the *E8257D/67D PSG Signal Generators Programming Guide*.

A waveform sequence is made up of segments but can also contain other sequences. Any number of segments, up to 32768, can be used to create a sequence. This limit count is determined by the number of segments in the waveform sequence. Segments and sequences can be repeated within a waveform sequence and the total of all segments and repeated segments cannot exceed the limit count. The following diagram shows a waveform sequence made up of two sequences and three segments. In this example the segment count is eleven.

Figure 3-9 Waveform Sequence Diagram

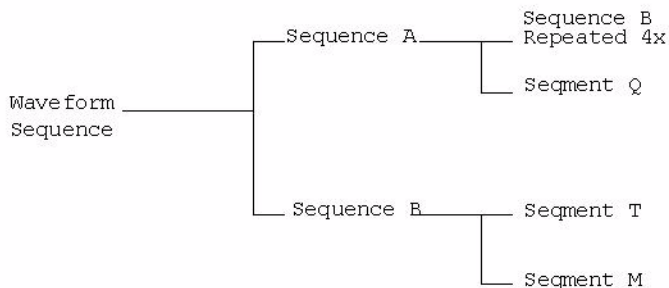

The following procedure describes how to create two waveform segments, then name and store them in ARB memory. After you name and store the two waveform segments in ARB memory, you can use them to build a waveform sequence, as described on [page 81](#).

1. Generate the first waveform:
 - a. Press **Preset > Mode > Two Tone > Alignment Left Cent Right** to **Right**.
 - b. Press **Two Tone Off On** to **On**, then to **Off**.
You turn off the Two Tone mode after generation because a waveform cannot be renamed as a segment while it is in use.

This generates a two tone waveform with the tone on the right placed at the carrier frequency. During waveform generation, the T-TONE and I/Q annunciators activate. The waveform is stored in volatile memory, with the default file name AUTOGEN_WAVEFORM.

NOTE Because there can be only one AUTOGEN_WAVEFORM waveform in memory at any given time, you must rename this file to clear the way for a second waveform.

2. Create the first waveform segment:
 - a. Press **Mode** > **Dual ARB** > **Waveform Segments** > **Load Store to Store**.
 - b. Highlight the default segment `AUTOGEN_WAVEFORM`.
 - c. Press **Rename Segment** > **Editing Keys** > **Clear Text**.
 - d. Enter a file name (for example, `TTONE`), and press **Enter** > **Store Segment To NVWFM Memory**.
This renames the waveform segment, and stores a copy in non volatile memory.
3. Generate the second waveform:
 - a. Press **Mode** > **Multitone** > **Initialize Table** > **Number Of Tones** > **9** > **Enter** > **Done**.
 - b. Press **Multitone Off On** to **On**, then **Off**.
Remember that a waveform cannot be renamed as a segment while it is in use.

This generates a multitone waveform with nine tones. During waveform generation, the M-TONE and I/Q annunciators activate. The waveform is stored in volatile memory with the default file name `AUTOGEN_WAVEFORM`.
4. Create the second waveform segment:

Repeat Step 2, giving this segment a descriptive name (for example, `MTONE`).

Building and Storing a Waveform Sequence

This example shows how to build and edit a waveform sequence using the two waveform segments created on [page 80](#). To use a segment in a sequence, the segment must reside in volatile memory; for information on loading waveform segments from non volatile to volatile memory, see [page 83](#).

1. Select the waveform segments:

Define a sequence as one repetition of the two-tone waveform segment followed by one repetition of the nine-tone multitone waveform segment.

 - a. Press **Mode** > **Dual ARB** > **Waveform Sequences** > **Build New Waveform Sequence** > **Insert Waveform**.
 - b. Highlight the a waveform segment (for example, `TTONE`) and press **Insert Selected Waveform**.
 - c. Highlight a second waveform segment (for example, `MTONE`) and press **Insert Selected Waveform**.
 - d. Press **Done Inserting**
2. **Optional:** Enable markers as desired for the segments in the new sequence: see [page 93](#).
3. Name and store the waveform sequence to the Catalog of Seq Files in the memory catalog:
 - a. Press **Name and Store**.
 - b. Enter a file name (for example, `TTONE+MTONE`).
 - c. Press **Enter**.

Playing a Waveform

This procedure applies to playing either a waveform segment or a waveform sequence. This example plays the waveform sequence created in the previous procedure.

1. Select a waveform sequence:
 - a. Press **Mode** > **Dual ARB** > **Select Waveform**.
 - b. Highlight a waveform sequence (for this example, TTONE+MTONE) from the Sequence column of the Select Waveform catalog, and press **Select Waveform**.

The display shows the currently selected waveform (for example, Selected Waveform: SEQ:TTONE+MTONE).

2. Generate the waveform:
Press **ARB Off On** to **On**.

This plays the selected waveform sequence.

During the waveform sequence generation, the ARB and I/Q annunciators activate.

Editing a Waveform Sequence

This example shows how to edit waveform segments within a waveform sequence, and then save the edited sequence under a new name. Within the editing display, you can change the number of times each segment plays (the repetitions), delete segments, add segments, toggle markers (described on [page 93](#)), and save changes.

NOTE If you do not store changes to the waveform sequence prior to exiting the waveform sequence editing display, the changes are removed.

1. Press **Waveform Sequences** > **Edit Selected Waveform Sequence**, and highlight the first entry.
2. Press **Edit Repetitions** > **100** > **Enter**. The second segment is automatically selected.
3. Press **Edit Repetitions** > **200** > **Enter**.
4. Save the edited file as a new waveform sequence:
 - a. Press **Name And Store**.
 - b. Press **Editing Keys** > **Clear Text**, then enter a new file name (for example, TTONE100+MTONE200).
 - c. Press **Enter**.

You have now changed the number of repetitions for each waveform segment entry from 1 to 100 and 200, respectively. The sequence has been stored under a new name to the Catalog of Seq Files in the signal generator's memory catalog.

For information on playing a waveform sequence, refer to [page 82](#).

Adding Real-Time Noise to a Dual ARB Waveform

The signal generator with option 403 can apply AWGN (additive white gaussian noise) to a carrier in real time while the modulating waveform file is being played by the Dual ARB waveform player. The AWGN can be configured using front-panel softkeys. The **Carrier to Noise Ratio** softkey allows you to specify the amount of noise power relative to carrier power that is applied to the signal. The **Carrier**

Bandwidth softkey sets the bandwidth over which the noise is integrated and the **Noise Bandwidth Factor** softkey allows you to select a flat noise bandwidth. These softkeys are described in the *E8257D/67D PSG Signal Generators Key Reference*.

The following procedure sets up a carrier and modulates it using the pre-defined SINE_TEST_WFM waveform file. AWGN is then applied to the carrier.

Configuring AWGN

1. Preset the signal generator. Press the **Preset** hardkey.
2. Press the **Frequency** hardkey and enter 15 GHz.
3. Press the **Amplitude** hardkey and enter -10 dBm.
4. Press **RF On Off** to **On**.
5. Press **Mode > Dual ARB > Select Waveform** and select the SINE_TEST_WFM waveform.
6. Press **Select Waveform**.
7. Press **ARB Off On** to **On**.
8. Press **ARB Setup > ARB Sample Clock** enter 50 MHz.
9. Press **Real-time Noise Setup > Carrier to Noise Ratio** and enter 30 dB.
10. Press **Carrier Bandwidth** and enter 40 MHz.
11. Press **Real-time Noise Off On** to **On**.

This procedure applies AWGN to the 15 GHz carrier. The displayed power level of the signal generator, -10 dBm, will include the noise power which is set as a carrier to noise ratio (C/N) of 30 dB. Noise power, for the purpose of C/N, is applied across a carrier bandwidth of 40 MHz. The default noise bandwidth factor is 1, which provides a flat noise signal bandwidth of a least 0.8 times the 50 MHz sample rate.

Storing and Loading Waveform Segments

Waveform segments can reside in volatile memory as WFM1 files, or they can be stored to non-volatile memory as NVWFM files, or both. To play or edit a waveform file, it must reside in volatile memory. Because files stored in volatile memory do not survive a power cycle, it is a good practice to store important files to non-volatile memory and load them to volatile memory whenever you want to use them.

Storing Waveform Segments to Non-volatile Memory

1. Press **Mode > Dual ARB > Waveform Segments**.
2. If necessary, press **Load Store** to **Store**.
3. Press **Store All To NVWFM Memory**.

Copies of all WFM1 waveform segment files have been stored in non-volatile memory as NVWFM files. To store files individually, highlight the file and press **Store Segment To NVWFM Memory**.

Loading Waveform Segments from Non-volatile Memory

1. Clear out the volatile memory and delete all WFM1 files: Power cycle the instrument.
2. Press **Mode > Dual ARB > Waveform Segments**.
3. If necessary, press **Load Store** to **Load**.
4. Press **Load All From NVWFM Memory**.

Copies of all NVWFM waveform segment files have been loaded into volatile memory as WFM1 files. To load files individually, highlight the file and press **Load Segment From NVWFM Memory**.

Renaming a Waveform Segment

1. Press **Mode > Dual ARB > Waveform Segments**.
2. Highlight the desired file and press **Rename Segment > Editing Keys > Clear Text**.
3. Enter the desired file name and then press **Enter**.

Using Waveform Markers

The signal generator provides four waveform markers to mark specific points on a waveform *segment*. When the signal generator encounters an enabled marker, an auxiliary output signal is routed to the rear panel event connector (described in [“Rear Panel” on page 18](#)) that corresponds to the marker number. You can use this auxiliary output signal to synchronize another instrument with the waveform, or as a trigger signal to start a measurement at a given point on a waveform.

You can also configure markers to initiate ALC hold, or RF Blanking (which includes ALC hold).

Creating a waveform segment ([page 80](#)) also creates a marker file that places a marker point on the first sample point of the segment for markers one and two. When a waveform file is downloaded that does not have a marker file associated with it, the signal generator creates a marker file without any marker points. Factory-supplied segments have a marker point on the first sample for all four markers.

The following procedures demonstrate how to use markers while working in the dual ARB player, but the process is the same when working in any ARB format.

These procedures also discuss two types of points: a *marker point* and a sample point. A marker point is a point at which a given marker is set on a waveform; you can set one or more marker points for each marker. A *sample point* is one of the many points that compose a waveform.

There are three basic steps to using waveform markers:

- “1. Clearing Marker Points from a Waveform Segment” on [page 90](#)
- “2. Setting Marker Points in a Waveform Segment” on [page 91](#)
- “3. Controlling Markers in a Waveform Sequence (Dual ARB Only)” on [page 93](#)

This section also provides the following information:

- [“Waveform Marker Concepts” on page 85](#)
- [“Accessing Marker Utilities” on page 88](#)
- [“Viewing Waveform Segment Markers” on page 89](#)
- [“Viewing a Marker Pulse” on page 95](#)

- “Using the RF Blanking Marker Function” on page 96
- “Setting Marker Polarity” on page 98

Waveform Marker Concepts

The signal generator’s ARB formats provide four waveform markers to mark specific points on a waveform segment. You can set each marker’s polarity and marker points (on a single sample point or over a range of sample points). Each marker can also perform ALC hold or RF Blanking and ALC hold.

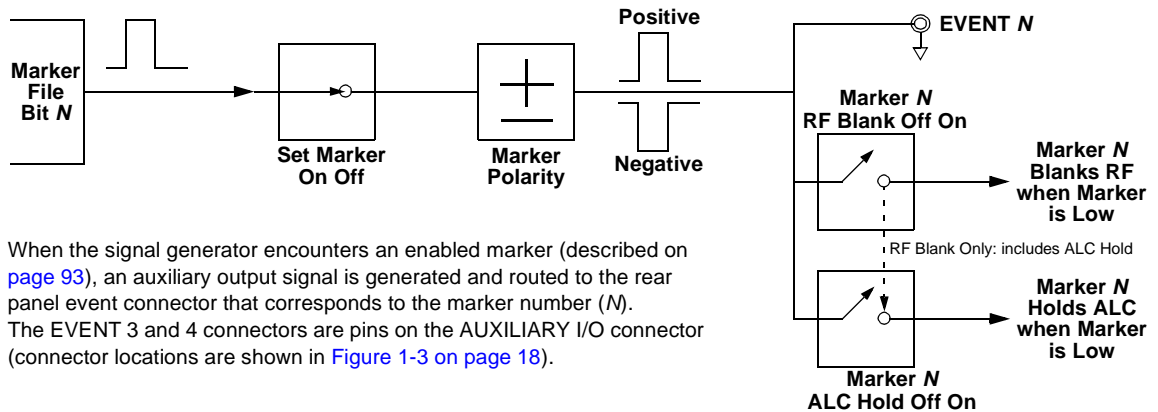

When the signal generator encounters an enabled marker (described on [page 93](#)), an auxiliary output signal is generated and routed to the rear panel event connector that corresponds to the marker number (N). The EVENT 3 and 4 connectors are pins on the AUXILIARY I/O connector (connector locations are shown in [Figure 1-3 on page 18](#)).

Marker File Generation

Generating a waveform segment (see [page 80](#)) automatically creates a marker file that places a marker point on the first sample point of the segment for markers one and two.

Downloading a waveform file (as described in the *E8257D/67D PSG Signal Generators Programming Guide*) that does not have a marker file associated with it creates a marker file that does *not* place any marker points.

Marker Point Edit Requirements

Before you can modify a waveform segment’s marker points, the segment must reside in volatile memory (see “[Loading Waveform Segments from Non-volatile Memory](#)” on [page 84](#)).

In the dual ARB player, you can modify a waveform segment’s marker points without playing the waveform, or while playing the waveform in an ARB modulation format.

In an ARB modulation format, you must play the waveform before you can modify a segment’s marker points.

Saving Marker Polarity and Routing Settings

Marker polarity and routing settings remain until you reconfigure them, preset the signal generator, or cycle the PSG power. To ensure that a waveform uses the correct settings when it is played, set the marker polarities or routing (RF Blanking and ALC Hold), and save the information to the file header (page 68). This is especially important when the segment plays as part of a sequence because the previously played segment could have different marker and routing settings.

ALC Hold Marker Function

While you can set a marker function (described as **Marker Routing** on the softkey label) either before or after you set marker points (page 91), setting a marker function before setting marker points may cause power spikes or loss of power at the RF output.

Use the ALC hold function by itself when you have a waveform signal that incorporates idle periods, or when the increased dynamic range encountered with RF blanking (page 96) is not desired.

The ALC hold marker function holds the ALC circuitry at the *average* (RMS) value of the sampled points set by the marker(s). For both positive and negative marker polarity, the ALC samples the RF output signal (the carrier plus any modulating signal) when the marker signal goes high:

- Positive: The signal is sampled during the on marker points.
- Negative: The signal is sampled during the off marker points.

The marker signal has a minimum of a two sample point delay in its response relative to the waveform signal response. To compensate for the marker signal delay, offset marker points from the waveform sample at which you want the ALC sampling to begin.

NOTE Because it can affect the waveform's output amplitude, do not use the ALC hold for longer than 100 ms. For longer time intervals, refer to "Setting Power Search Mode" on page 241.

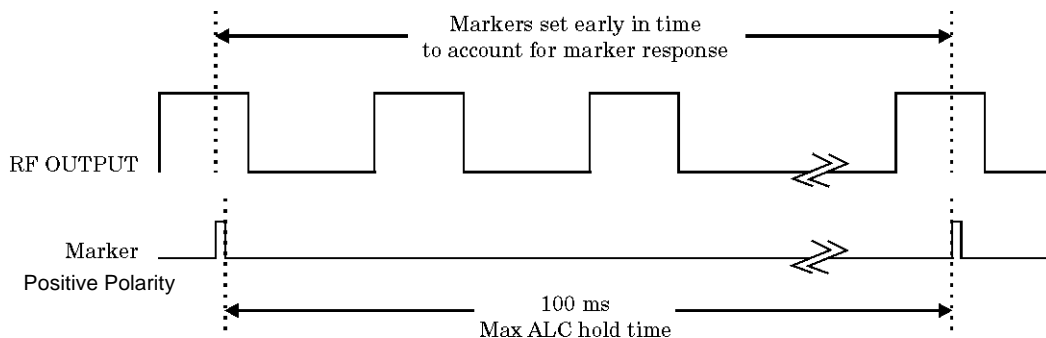

CAUTION Incorrect ALC sampling can create a sudden unlevelled condition that may create a spike in the RF output, potentially damaging a DUT or connected instrument. To prevent this condition, ensure that you set markers to let the ALC sample over an amplitude that accounts for the higher power levels encountered within the signal.

Example of Correct Use

Waveform: 1022 points
Marker range: 95-97
Marker polarity: Positive

This example shows a marker set to sample the waveform's area of highest amplitude. Note that the marker is set well before the waveform's area of lowest amplitude. This takes into account the response difference between the marker and the waveform signal.

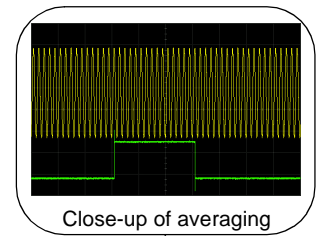
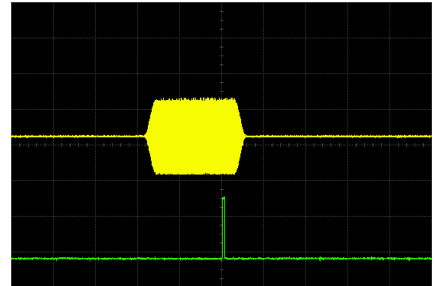

Close-up of averaging

The ALC samples the waveform when the marker signal goes high, and uses the average of the sampled waveform to set the ALC circuitry.

Here the ALC samples during the *on* marker points (positive polarity).

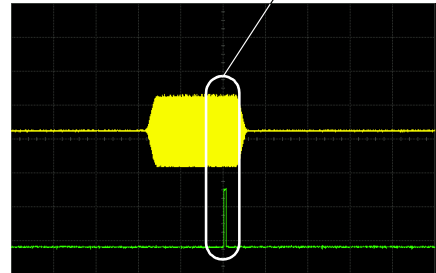

Example of Incorrect Use

Waveform: 1022 points
Marker range: 110-1022
Marker polarity: Positive

This example shows a marker set to sample the low part of the same waveform, which sets the ALC modulator circuitry for that level; this usually results in an unlevelled condition for the signal generator when it encounters the high amplitude of the pulse.

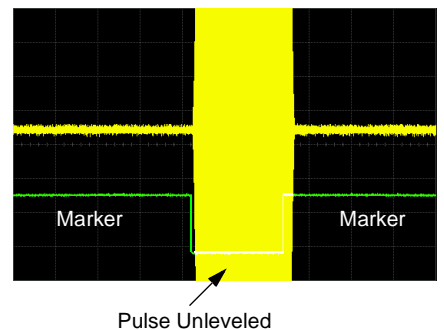

Example of Incorrect Use

Waveform: 1022 points
Marker range: 110-1022
Marker polarity: Negative

This figure shows that a negative polarity marker goes low during the marker *on* points; the marker signal goes high during the *off* points. The ALC samples the waveform during the *off* marker points.

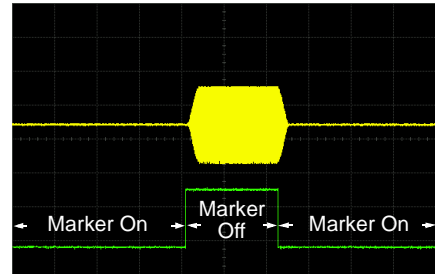

Sample range begins on first point of signal

Sampling both on and off time sets the modulator circuitry incorrectly for higher signal levels. Note the increased amplitude at the beginning of the pulse.

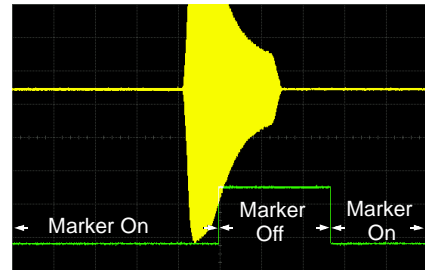

Negative range set between signal and off time

Accessing Marker Utilities

Use the following procedure to display the marker parameters. This procedure uses the Dual ARB player, but you can access the marker utilities through the **ARB Setup** softkey in all ARB formats.

1. Select the ARB waveform player:
press **Mode** > **Dual ARB**
2. Press **ARB Setup** > **Marker Utilities**.

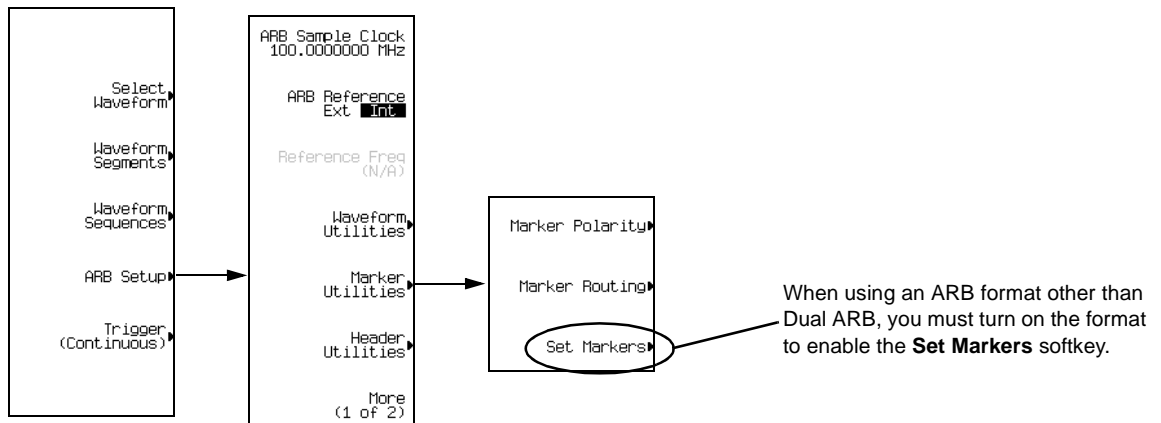

NOTE Most of the procedures in this section begin at the **Marker Utilities** softkey menu.

Viewing Waveform Segment Markers

Markers are applied to waveform segments. Use the following steps to view the markers set for a segment (this example uses the factory-supplied segment, SINE_TEST_WFM).

1. In the Marker Utilities menu ([page 88](#)), press **Set Markers**.
2. Highlight the desired waveform segment.
In an ARB format, there is only one file (AUTOGEN_WAVEFORM) and it is already highlighted.
3. Press **Display Markers > Zoom in Max**. The maximum zoom in range is 28 points.

Experiment with the Zoom functions to see how they display the markers.

The display can show a maximum of 460 points; displayed waveforms with a sample point range greater than 460 points may not show the marker locations.

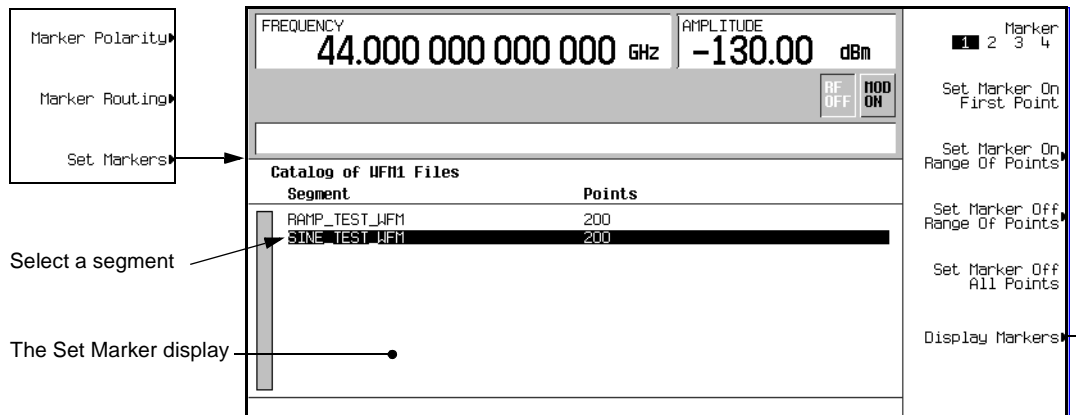

The display below shows the I and Q components of the waveform, and the marker points set in a factory-supplied segment.

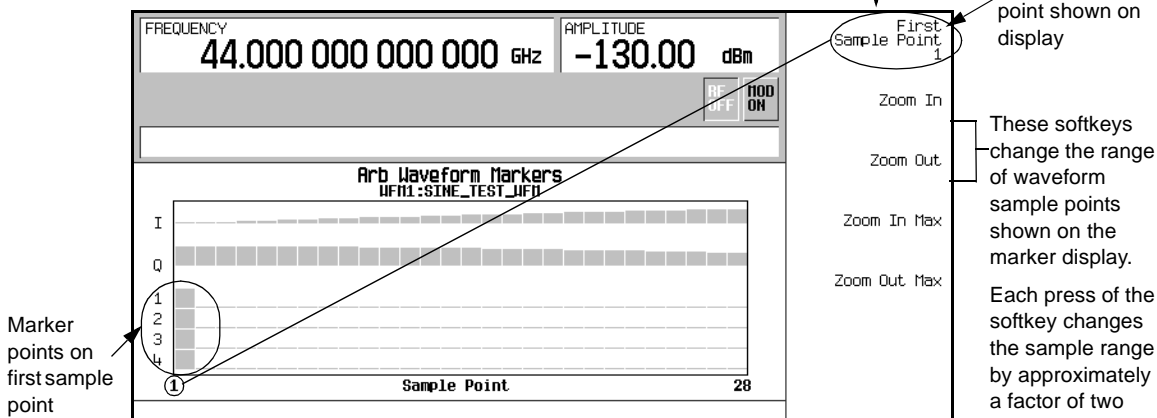

1. Clearing Marker Points from a Waveform Segment

When you set marker points they do not replace points that already exist, but are set *in addition* to existing points. Because markers are cumulative, before you set points, view the segment (page 89) and remove any unwanted points. With all markers cleared, the level of the event output signal is 0V.

Clearing All Marker Points

1. In the Marker Utilities menu (page 88), press Set Markers.
2. Highlight the desired waveform segment.
In an ARB format, there is only one file (AUTOGEN_WAVEFORM) and it is already highlighted.
3. Highlight the desired marker number:
Press Marker 1 2 3 4.

4. For the selected marker number, remove all marker points in the selected segment:
Press **Set Marker Off All Points**.
5. Repeat from [Step 3](#) for any remaining marker points that you want to remove.

Clearing a Range of Marker Points

The following example uses a waveform with marker points (Marker 1) set across points 10–20. This makes it easy to see the affected marker points. The same process applies whether the existing points are set over a range ([page 91](#)) or as individual points ([page 92](#)).

1. In the Marker Utilities menu ([page 88](#)), select the desired marker (for this example, Marker 1).
2. Set the first sample point that you want off (for this example, 13):
Press **Set Marker Off Range Of Points > First Mkr Point > 13 > Enter**.
3. Set the last marker point in the range that you want off to a value less than or equal to the number of points in the waveform, *and* greater than or equal to the value set in [Step 2](#) (for this example, 17):
Press **Last Mkr Point > 17 > Enter > Apply To Waveform > Return**.

This turns off all marker points for the active marker within the range set in [Steps 2](#) and [3](#), as shown in the following figure.

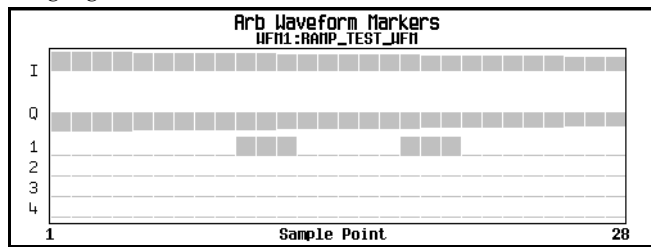

Viewing markers is described on [page 89](#)

Clearing a Single Marker Point

Use the steps described in [“Clearing a Range of Marker Points” on page 91](#), but set both the first and last marker point to the value of the point you want to clear. For example, if you want to clear a marker on point 5, set both the first and last value to 5.

2. Setting Marker Points in a Waveform Segment

To set marker points on a segment, the segment must reside in volatile memory ([page 84](#)).

When you set marker points, they do not replace points that already exist, but are set *in addition* to existing points. Because markers are cumulative, before you set marker points within a segment, view the segment ([page 89](#)) and remove any unwanted points ([page 90](#)).

Placing a Marker Across a Range of Points

1. In the Marker Utilities menu ([page 88](#)), press **Set Markers**.
2. Highlight the desired waveform segment.
In an ARB format, there is only one file (AUTOGEN_WAVEFORM) and it is already highlighted.

3. Highlight the desired marker number:

Press **Marker 1 2 3 4**

4. Set the first sample point in the range (in this example, 10):

Press **Set Marker On Range Of Points > First Mkr Point > 10 > Enter.**

5. Set the last marker point in the range to a value less than or equal to the number of points in the waveform, *and* greater than or equal to the first marker point (in this example, 20):

Press **Last Mkr Point > 20 > Enter.**

6. Press **Apply To Waveform > Return.**

This sets a range of waveform marker points. The marker signal starts on sample point 10, and ends on sample point 20, as shown in the following figure.

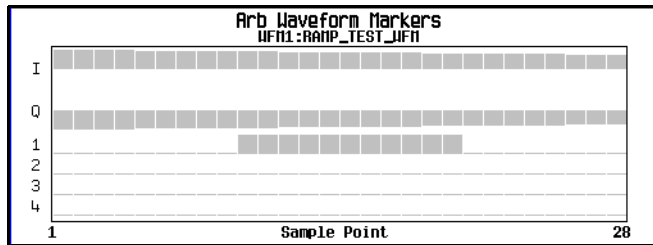

Viewing markers is described on [page 89](#)

Placing a Marker on a Single Point

On the First Point

1. In the Marker Utilities menu ([page 88](#)), press **Set Markers**.
2. Highlight the desired waveform segment.
In an ARB format, there is only one file (AUTOGEN_WAVEFORM) and it is already highlighted.
3. Highlight the desired marker number:

Press **Marker 1 2 3 4**

4. Press **Set Marker On First Point**.

This sets a marker on the first point in the segment for the marker number selected in [Step 3](#).

On Any Point

Use the steps described in “[Placing a Marker Across a Range of Points](#)” on [page 91](#), but set both the first and last marker point to the value of the point you want to set. For example, if you want to set a marker on point 5, set both the first and last value to 5.

Placing Repetitively Spaced Markers

The following example sets markers across a range of points and specifies the spacing (skipped points) between each marker. You must set the spacing *before* you apply the marker settings; you cannot apply skipped points to a previously set range of points.

1. Remove any existing marker points ([page 90](#)).
2. In the Marker Utilities menu ([page 88](#)), press Set Markers.
3. Highlight the desired waveform segment.
In ARB formats there is only one file (AUTOGEN_WAVEFORM) and it is already highlighted.
4. Highlight the desired marker number: Press Marker 1 2 3 4
5. Set the first sample point in the range (in this example, 5):
Press Set Marker On Range Of Points > First Mkr Point > 5 > Enter.
6. Set the last marker point in the range to a value less than the number of points in the waveform, *and* greater than or equal to the first marker point (in this example, 25):
Press Last Mkr Point > 25 > Enter.
7. Enter the number of sample points that you want skipped (in this example, 1):
Press # Skipped Points > 1 > Enter.
8. Press Apply To Waveform > Return.

This causes the marker to occur on every other point (one sample point is skipped) within the marker point range, as shown below.

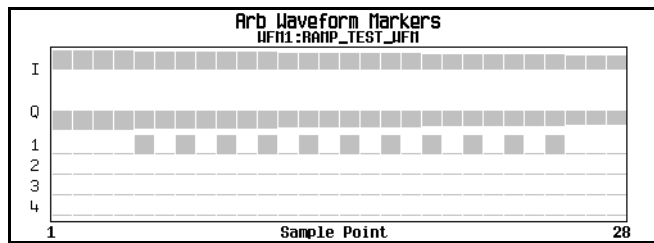

Viewing markers is described on [page 89](#)

One application of the skipped point feature is the creation of a clock signal as the auxiliary output.

3. Controlling Markers in a Waveform Sequence (Dual ARB Only)

In a waveform segment, an enabled marker point generates an auxiliary output signal that is routed to the rear panel event connector (described in [“Rear Panel” on page 18](#)) corresponding to that marker number. For a waveform sequence, you enable or disable markers on a segment-by-segment basis; this enables you to output markers for some segments in a sequence, but not for others. Unless you change the marker settings or cycle the power, the setting remains the same for the next loaded sequence.

As You Create a Waveform Sequence

After you select the waveform segments to create a waveform sequence, and *before* you name and save the sequence, you can enable or disable each segment’s markers independently. Enabling a marker that has no marker points ([page 91](#)) has no effect on the auxiliary outputs.

1. Select the waveform segments ([Step 1 on page 81](#)).

2. Toggle the markers as desired:
 - a. Highlight the first waveform segment.
 - b. Press **Enable/Disable Markers**.
 - c. As desired, press **Toggle Marker 1**, **Toggle Marker 2**, **Toggle Marker 3**, and **Toggle Marker 4**.
Toggling a marker that has no marker points (page 91) has no effect on the auxiliary outputs.
An entry in the **Mkr** column (see figure below) indicates that the marker is enabled for that segment; no entry in the column means that all markers are disabled for that segment
 - d. In turn, highlight each of the remaining segments and repeat **Step c**.
3. Press **Return**.
4. Name and store the waveform sequence (**Step 3** on page 81).

The following figure shows a sequence built reusing the same factory-supplied waveform segment; a factory-supplied segment has a marker point on the first sample for all four markers. In this example, Marker 1 is enabled for the first segment, Marker 2 is enable for the second segment, and markers 3 and 4 are enabled for the third segment.

(1/2)	Segment	SINE_TEST_WFM Sequence	(UNSTORED) (1/1)	Waveform	Reps	Mkr	UNTITLED
	AUTOGEN_PPRM_1	2KKL2KKM		WFM1:SINE_TEST_WFM	1	1	
	RAMP_TEST_WFM	A		WFM1:SINE_TEST_WFM	1	2	
	SINE_TEST_WFM	AR2		WFM1:SINE_TEST_WFM	1	3,4	
		B					
		COMPLEX					

Toggle Marker 3

Toggle Marker 4

Sequence Marker Column

This entry shows that markers 3 and 4 are enabled for this segment.

For each segment, only the markers enabled for that segment produce a rear-panel auxiliary output signal. In this example, the Marker 1 auxiliary signal appears only for the first segment, because it is disabled for the remaining segments. The Marker 2 auxiliary signal appears only for the second segment, and the marker 3 and 4 auxiliary signals appear only for the third segment.

In an Existing Waveform Sequence

If you have not already done so, create and store a waveform sequence that contains at least three segments (page 81). Ensure that the segment or segments are available in volatile memory (page 84).

1. Press **Mode > Dual ARB > Waveform Sequences**, and highlight the desired waveform sequence.
2. Press **Edit Selected Waveform Sequence**, and highlight the first waveform segment.
3. Press **Enable/Disable Markers > Toggle Marker 1**, **Toggle Marker 2**, **Toggle Marker 3**, and **Toggle Marker 4**.
Toggling a marker that has no marker points (page 91) has no effect on the auxiliary outputs.
An entry in the **Mkr** column indicates that the marker is enabled for that segment; no entry in the column means that all markers are disabled for that segment
4. Highlight the next waveform segment and toggle the desired markers (in this example, markers 1 and 4).
5. Repeat **Step 4** as desired (for this example, select the third segment and toggle marker 3).
6. Press **Return > Name And Store > Enter**.

The markers are enabled or disabled per your selections, and the changes have been saved to the selected sequence file.

(1/1)	Segment	Sequence	(UNSTORED) (1/1)	Waveform	Reps#	Filter
	RAMP_TEST_WFM	EXAMPLE	WF11:	SINE_TEST_WFM	1	1234
	SINE_TEST_WFM	EXAMPLE2	WF11:	RAMP_TEST_WFM	1	1 4
		GW_SEQ	WF11:	SINE_TEST_WFM	1	3
		G_64+9CH_CDMA				
		ULTRATONE_SEQUENCE				
		SINE_X_20_SEG				
		T1				
		WCDMA+GSM_X1EA				

Viewing a Marker Pulse

When a waveform plays (page 82), you can detect a set and enabled marker's pulse at the rear panel event connector that corresponds to that marker number. This example demonstrates how to view a marker pulse generated by a waveform segment that has at least one marker point set (page 91). The process is the same for a waveform sequence.

This example uses the factory-supplied segment, SINE_TEST_WFM in the Dual ARB Player. Factory-supplied segments have a marker point on the first sample point for all four markers, as shown.

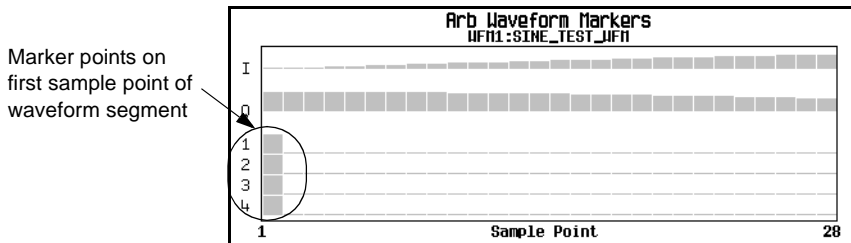

Viewing markers is described on page 89

1. Press **Mode** > **Dual ARB** > **Select Waveform**, and highlight the desired segment (in this example, SINE_TEST_WFM).
2. Press **ARB Off On** to **On**.
3. Connect an oscilloscope input to the **EVENT 1** connector, and trigger on the **Event 1** signal. When a marker is present, the oscilloscope displays a marker pulse, as shown in the following example.

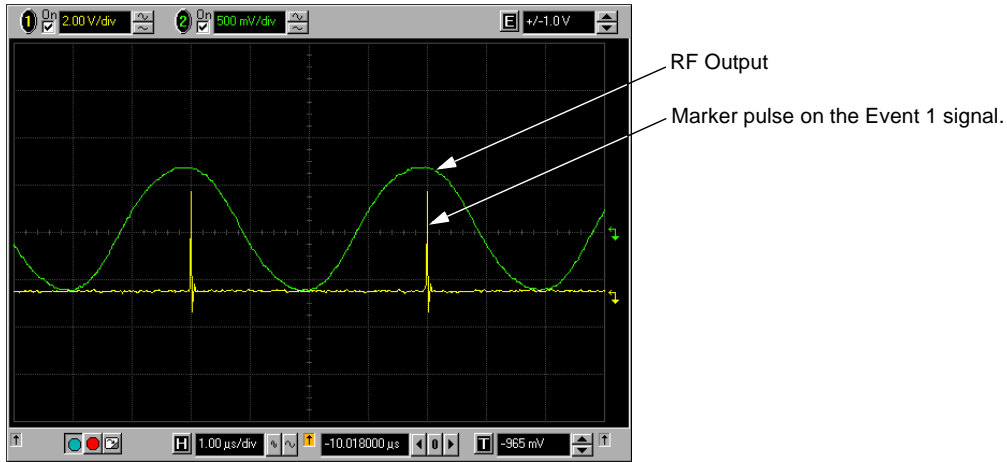

Using the RF Blanking Marker Function

While you can set a marker function (described as **Marker Routing** on the softkey label) either before or after setting the marker points ([page 91](#)), setting a marker function before you set marker points may change the RF output. RF Blanking includes ALC hold (described on [page 86](#), note **Caution** regarding unlevelled power). The signal generator blanks the RF output when the marker signal goes low.

1. Using the factory-supplied segment SINE_TEST_WFM, set Marker 1 across points 1–180 ([page 91](#)).
2. From the **Marker Utilities** menu ([page 88](#)), assign RF Blanking to Marker 1:
Press **Marker Routing > Pulse/RF Blank > Marker 1**.

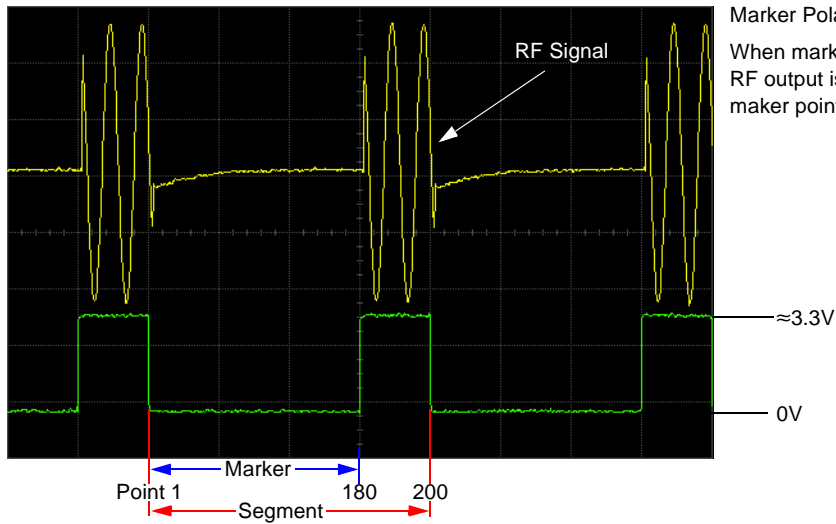
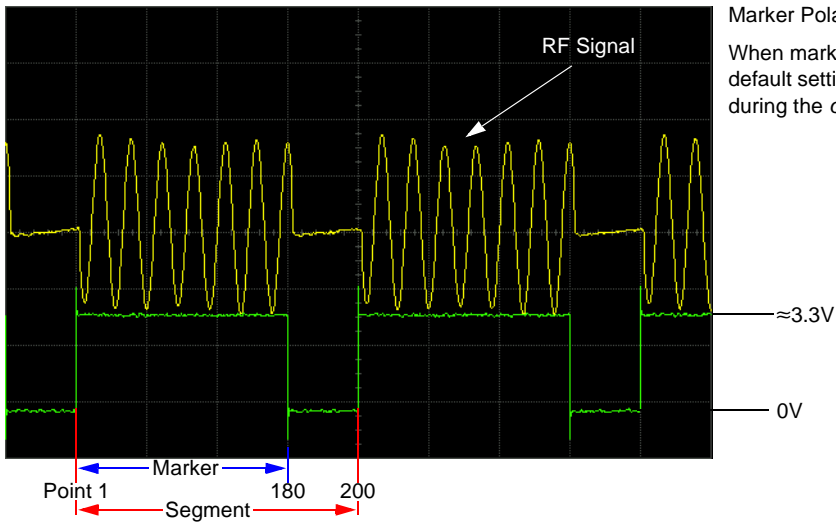

Setting Marker Polarity

Setting a negative marker polarity inverts the marker signal.

1. In the **Marker Utilities** menu ([page 88](#)), press **Marker Polarity**.
2. Select the marker polarity as desired for each marker number.

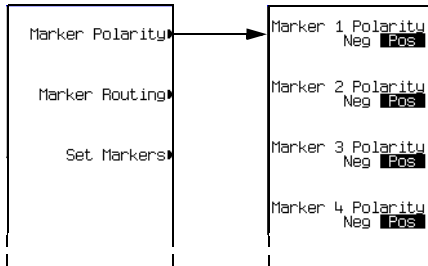

Default Marker Polarity = Positive

Set each marker polarity independently.

See Also: [“Saving Marker Polarity and Routing Settings” on page 86.](#)

As shown on [page 96](#):

Positive Polarity: *On* marker points are high ($\approx 3.3V$).

Negative Polarity: *On* marker points are low (0V).

Triggering Waveforms

Triggering is available in both ARB and real-time formats. ARB triggering controls the playback of a waveform file; real-time custom triggering controls the transmission of a data pattern. The examples and discussions in this section use the Dual ARB Player, but the functionality and method of access (described on [page 100](#)) are similar in all (ARB and real-time) formats.

Triggers control data transmission by telling the PSG when to transmit the modulating signal. Depending on the trigger settings, the data transmission may occur once, continuously, or the PSG may start and stop the transmission repeatedly (Gated mode).

A trigger signal comprises both positive and negative signal transitions (states), which are also called high and low periods; you can configure the PSG to trigger on either state. It is common to have multiple triggers, also referred to as trigger occurrences or trigger events, occur when the signal generator requires only a single trigger. In this situation, the PSG recognizes the first trigger event and ignores the rest.

When you select a trigger mode, you may lose the signal (carrier plus modulation) from the RF output until you trigger the modulating signal. This is because the PSG sets the I and Q signals to zero volts prior to the first trigger event, which suppresses the carrier. If you create a data pattern with the initial I and Q voltages set to values other than zero, this does not occur. After the first trigger event, the signal's final I and Q levels determine whether you see the carrier signal or not (zero = no carrier, other values = visible carrier). At the end of most data patterns, the final I and Q points are set to a value other than zero.

There are four parts to configuring a waveform trigger:

- *Source* determines how the PSG receives the trigger that initiates waveform play.
- *Mode* determines the waveform's overall behavior when it plays.
- *Response* determines the specifics of how the waveform responds to a trigger.

- *Polarity* determines the state of the trigger to which the waveform responds (used only with an external trigger source); you can set either negative, or positive.

Source

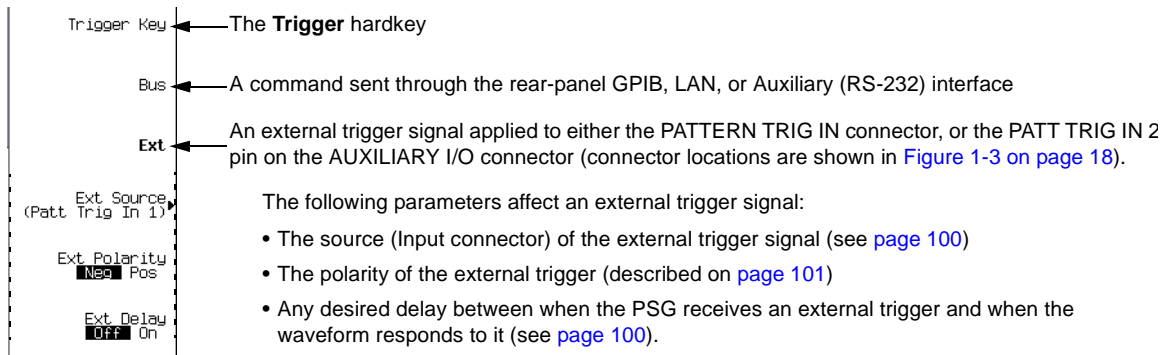

Mode and Response

The arbitrary waveform player provides four trigger *modes*; each mode has one or more possible *responses*:

- **Single** plays the waveform once. *Arb formats* have the following retriggering options:
 - **Off** ignores triggers received during play; a trigger received after playback completes restarts the playback.
 - **On** causes a trigger received during play to repeat the waveform after the current play completes.
 - **Immediate** causes a trigger received during play to immediately restart the waveform.
- **Gated** causes the waveform to wait for the first active trigger signal state to begin transmission, then repeatedly start and stop in response to an externally applied gating signal (example on [page 101](#)). You select the active state with the **Gate Active Low High** softkey (see [page 101](#)).

In an ARB format, the waveform plays during the *inactive* state, and stops during the *active* state.

In real-time Custom, behavior depends on whether the signal incorporates framed or unframed data.

Because the PSG provides only unframed data, to transmit a framed data signal you must create an external file that incorporates the framing and download it to the PSG (see the *E8257D/67D PSG Signal Generators Programming Guide*).

- *Unframed data* transmits during active states, and stops during inactive states. The signal stops at the last transmitted symbol and restarts at the next symbol.
- *Framed data* starts transmitting at the beginning of a frame during active states, and stops at the end of a frame when the end occurs during inactive states. If the end of the frame extends into the next active state, the signal transmits continuously.

- **Segment Advance** (Dual ARB only) causes a segment in a sequence to require a trigger to play. The *trigger source* controls how play moves from segment to segment (example on [page 103](#)). A trigger received during the last segment loops play to the *first* segment in the sequence. You have two choices as to how the segments play:
 - **Single** causes a segment in a sequence to play once, then to stop and wait for a trigger before advancing to the next segment, which plays to completion. Triggers received during play cause the current segment to finish, then play advances to the next segment, which plays to completion.
 - **Continuous** causes a segment in a sequence to play continuously until the waveform receives another trigger. Triggers received during play cause the current segment to finish, then play advances to the next segment, which plays continuously.
- **Continuous** repeats the waveform until you turn the signal off or select another waveform, trigger mode, or response. Continuous has the following options:
 - **Free Run** immediately triggers and plays the waveform; triggers received during play are ignored.
 - **Trigger & Run** plays the waveform when a trigger is received; subsequent triggers are ignored.
 - **Reset & Run** (not available in real-time Custom) plays the waveform when a trigger is received; subsequent triggers restart the waveform.

Accessing Trigger Utilities

The following figures show the menus for the trigger parameters. These figures show the Dual ARB player, but you can access the trigger utilities through the **Trigger** softkey in all ARB formats, and the **Pattern Trigger** softkey in the Real Time I/Q Baseband (Custom) format.

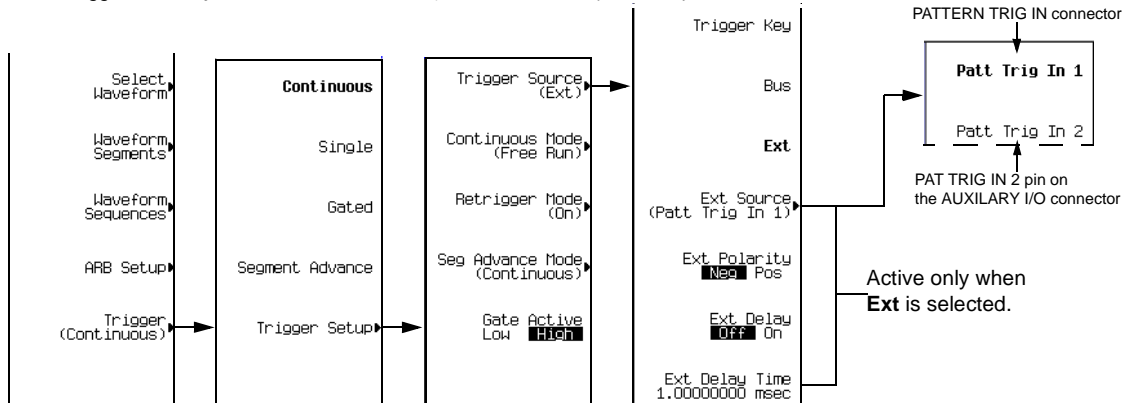

- To display the trigger modes, press **Mode > Dual ARB > Trigger**.
- To display the response selections available for a given trigger mode, press **Trigger Setup**, then select the desired trigger mode. To see the selections for Single mode in an ARB format, select **Retrigger Mode**; in real-time Custom, selecting Single mode causes the data pattern to play once when triggered.
- To display the trigger source options, press **Trigger Setup > Trigger Source**.

Setting the Polarity of an External Trigger

Gated Mode

The selections available with the gate active parameter refer to the low and high states of an external trigger signal. For example, when you select High, the active state occurs during the high of the trigger signal.

ARB Formats When the active state occurs, the PSG *stops* the waveform file playback at the last played sample point, and restarts the playback at the next sample point when the inactive state occurs.

Real-Time Custom When the active state occurs, the PSG *transmits* the data pattern. When the inactive state occurs, the transmission stops at the last transmitted symbol, and restarts at the next symbol when the active state occurs.

Continuous, Single, or Segment Advance Modes

The Ext Polarity Neg Pos softkey selections refer to the low (negative) and high (positive) states of an external trigger. With Neg selected (the default), the PSG responds during the low state of the trigger signal.

Using Gated Triggering

Gated triggering enables you to define the on (playback) and off states of a modulating waveform. This example uses the factory supplied segment, SINE_TEST_WFM.

1. Connect the output of a function generator to the signal generator's rear-panel PATTERN TRIG IN, as shown in the following figure.

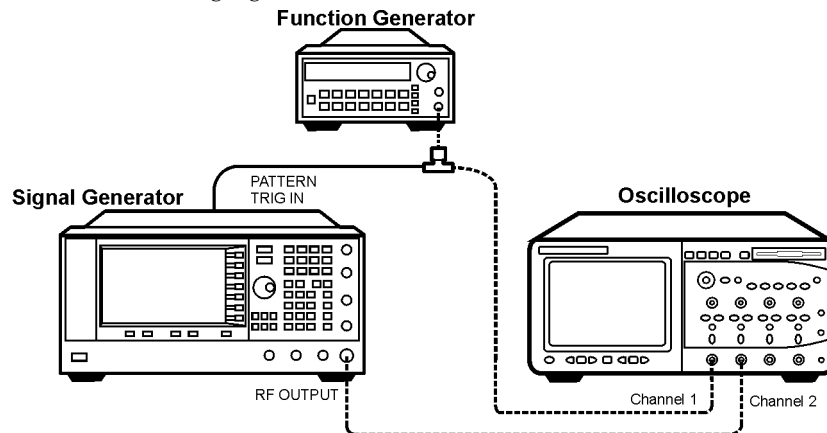

This connection is applicable to all external triggering methods. The optional oscilloscope connection enables you to see the effect that the trigger signal has on the RF output.

2. Preset the signal generator.

3. Configure the carrier signal output:
 - Set the desired frequency.
 - Set the desired amplitude.
 - Turn on the RF output.
4. Select a waveform for playback (sequence or segment):
 - a. Preset the signal generator.
 - b. Press **Mode** > **Dual ARB** > **Select Waveform**.
 - c. Highlight a waveform file (for this example, `SINE_TEST_WFM`).
 - d. Press **Select Waveform**.
5. Select the waveform trigger method:
 - a. Press **Trigger** > **Gated**.
 - b. Press **Trigger** > **Trigger Setup** and note that for the **Gate Active Low High** softkey, the default selection is **High**, which is the selection used in this example.
6. Select the trigger source and rear panel input:
 - a. For the **Trigger Source** softkey, the default selection is **Ext**, which is the selection used in this example (gated triggering requires an external trigger).
 - b. Press **Trigger Source** and note that for the **Ext Source** softkey, the default selection is **Patt Trig In 1**, which is the selection used in this example.
7. Generate the waveform:

Press **ARB Off On** to **On**.
8. On the function generator, configure a TTL signal for the external gating trigger.
9. (Optional) Monitor the current waveform:

Configure the oscilloscope to display both the output of the signal generator, and the external triggering signal. You will see the waveform modulating the output during the gate *inactive* periods (low).

The following figure shows an example display.

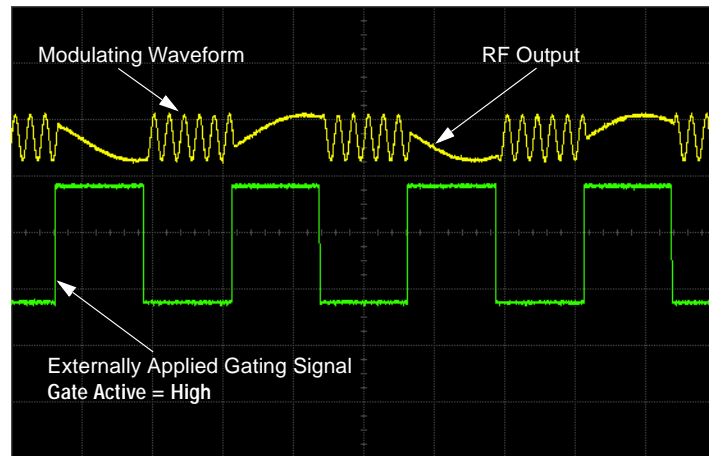

NOTE In the real-time Custom mode, the behavior is reversed: when the gating signal is *high*, you see the modulated waveform.

Using Segment Advance Triggering

Segment advance triggering enables you to control the segment playback within a waveform sequence. The following example uses a waveform sequence that has two segments.

If you have not created and stored a waveform sequence, complete the steps in the sections, [“Creating Waveform Segments”](#) on page 80, and [“Building and Storing a Waveform Sequence”](#) on page 81.

1. Preset the signal generator.
2. Configure the RF output:
 - Set the desired frequency.
 - Set the desired amplitude.
 - Turn on the RF output.
3. Select a waveform sequence for playback:
 - a. Press **Mode** > **Dual ARB** > **Select Waveform**.
 - b. Highlight a waveform sequence file.
 - c. Press **Select Waveform**.
4. Select the waveform trigger method and trigger source:
 - a. Press **Trigger** > **Segment Advance**.
 - b. Press **Trigger** > **Trigger Setup** and note that the **Seg Advance Mode** softkey displays the default selection (Continuous), which is the selection used in this example.
 - c. Press **Trigger Source** > **Trigger Key**.

5. Generate the waveform sequence:
Press **Return** > **Return** > **ARB Off On** to On.
6. Trigger the first waveform segment to begin playing repeatedly:
Press the **Trigger** hardkey.
7. (Optional) Monitor the current waveform:
Connect the output of the signal generator to the input of an oscilloscope, and configure the oscilloscope so that you can see the output of the signal generator.
8. Trigger the second segment:
Press the **Trigger** hardkey.

The second segment in the sequence now plays. Pressing the **Trigger** hardkey causes the current playback to finish and the next segment to start; when the last segment plays, pressing the **Trigger** hardkey causes the *first* segment in the waveform sequence to start when the current segment finishes.

Using Waveform Clipping

Waveforms with high power peaks can cause intermodulation distortion, which generates spectral regrowth (a condition that interferes with signals in adjacent frequency bands). The clipping function enables you to reduce high power peaks by clipping the I and Q data to a selected percentage of its highest peak.

The clipping feature is available only with the Dual ARB mode.

How Power Peaks Develop

To understand how clipping reduces high power peaks, it is important to know how the peaks develop as the signal is constructed.

I/Q waveforms can be the summation of multiple channels (see [Figure 3-10](#)). Whenever most or all of the individual channel waveforms simultaneously contain a bit in the same state (high or low), an unusually high power peak (negative or positive) occurs in the summed waveform. This does *not* happen frequently because the high and low states of the bits on these channel waveforms are random, which causes a cancelling effect.

Figure 3-10

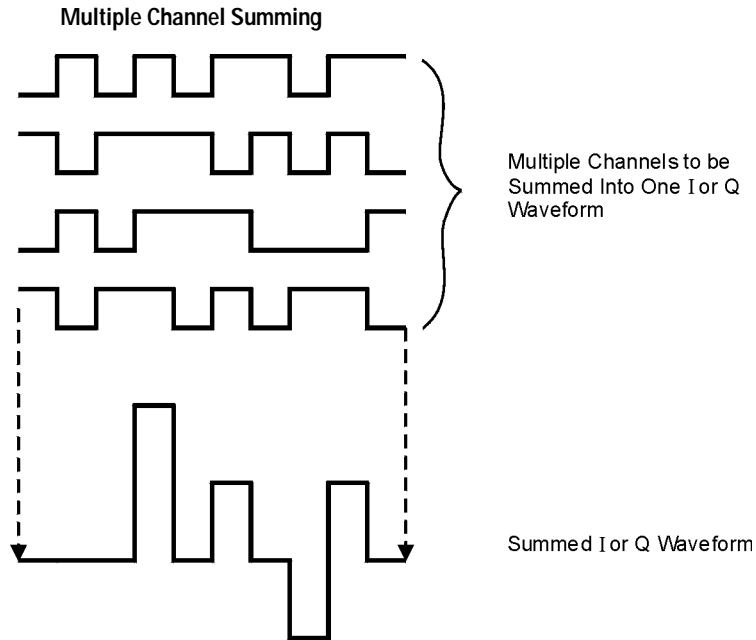

The I and Q waveforms combine in the I/Q modulator to create an RF waveform. The magnitude of the RF envelope is determined by the equation $\sqrt{I^2 + Q^2}$, where the squaring of I and Q always results in a positive value.

As shown in [Figure 3-11](#), simultaneous positive and negative peaks in the I and Q waveforms do not cancel each other, but combine to create an even greater peak.

Figure 3-11 Combining the I and Q Waveforms

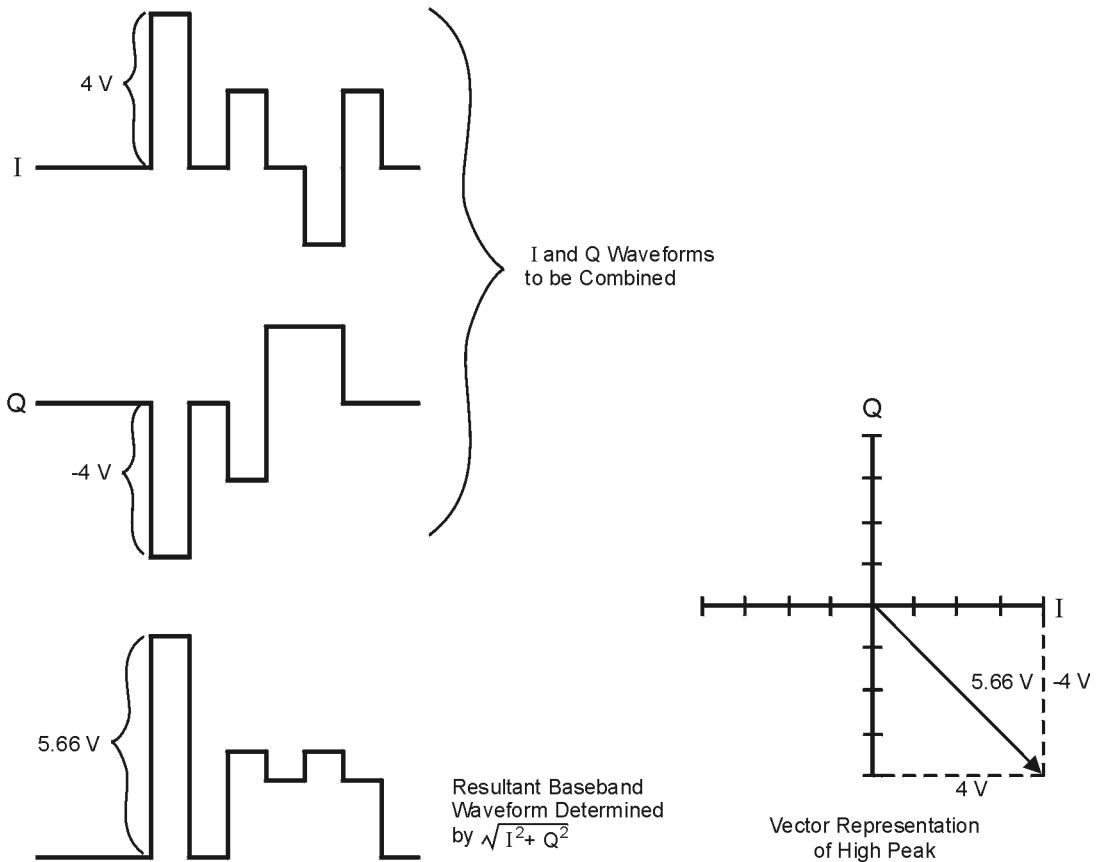

How Peaks Cause Spectral Regrowth

Because of the relative infrequency of high power peaks, a waveform will have a high peak-to-average power ratio (see Figure 3-12). Because a transmitter's power amplifier gain is set to provide a specific average power, high peaks can cause the power amplifier to move toward saturation. This causes intermodulation distortion, which generates spectral regrowth.

Figure 3-12

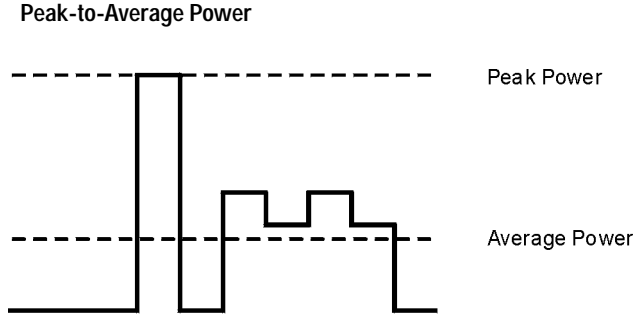

Spectral regrowth is a range of frequencies that develops on each side of the carrier (similar to sidebands) and extends into the adjacent frequency bands (see [Figure 3-13](#)). Consequently, spectral regrowth interferes with communication in the adjacent bands. Clipping can provide a solution to this problem.

Figure 3-13

Spectral Regrowth Interfering with Adjacent Band

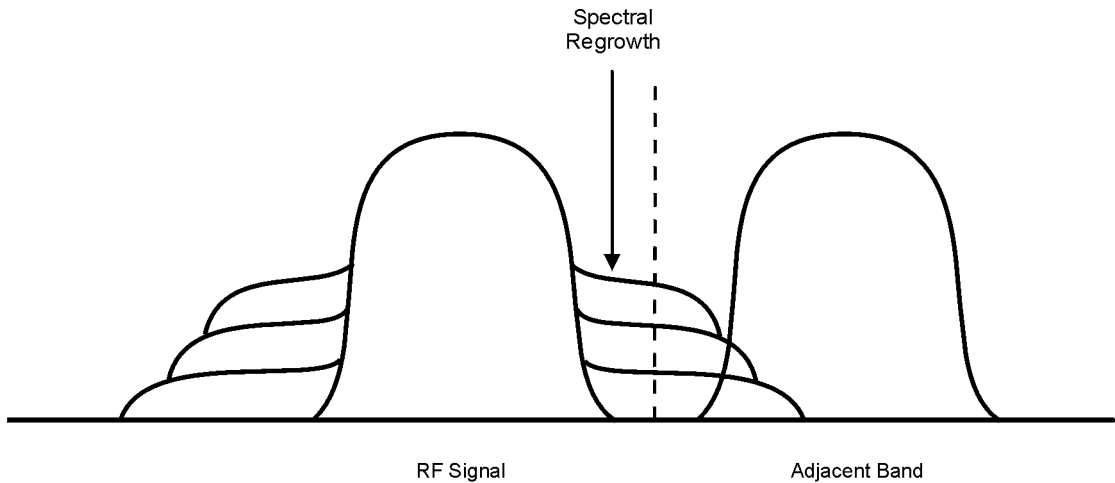

How Clipping Reduces Peak-to-Average Power

You can reduce peak-to-average power, and consequently spectral regrowth, by clipping the waveform to a selected percentage of its peak power. The PSG vector signal generator provides two different methods of clipping: circular and rectangular.

During *circular* clipping, clipping is applied to the combined I and Q waveform ($|I + jQ|$). Notice in [Figure 3-14](#) that the clipping level is constant for all phases of the vector representation and appears as a circle. During *rectangular* clipping, clipping is applied to the I and Q waveforms separately ($|I|$, $|Q|$). Notice in [Figure 3-15](#) on page 109 that the clipping level is different for I and Q; therefore, it

appears as a rectangle in the vector representation. With either method, the objective is to clip the waveform to a level that effectively reduces spectral regrowth, but does *not* compromise the integrity of the signal. [Figure 3-16 on page 110](#) uses two complementary cumulative distribution plots to show the reduction in peak-to-average power that occurs after applying circular clipping to a waveform.

The lower you set the clipping value, the lower the peak power that is passed (or the more the signal is clipped). Often, the peaks can be clipped successfully without substantially interfering with the rest of the waveform. Data that might be lost in the clipping process is salvaged because of the error correction inherent in the coded systems. If you clip too much of the waveform, however, lost data is irrecoverable. You may have to try several clipping settings to find a percentage that works well.

Figure 3-14 Circular Clipping

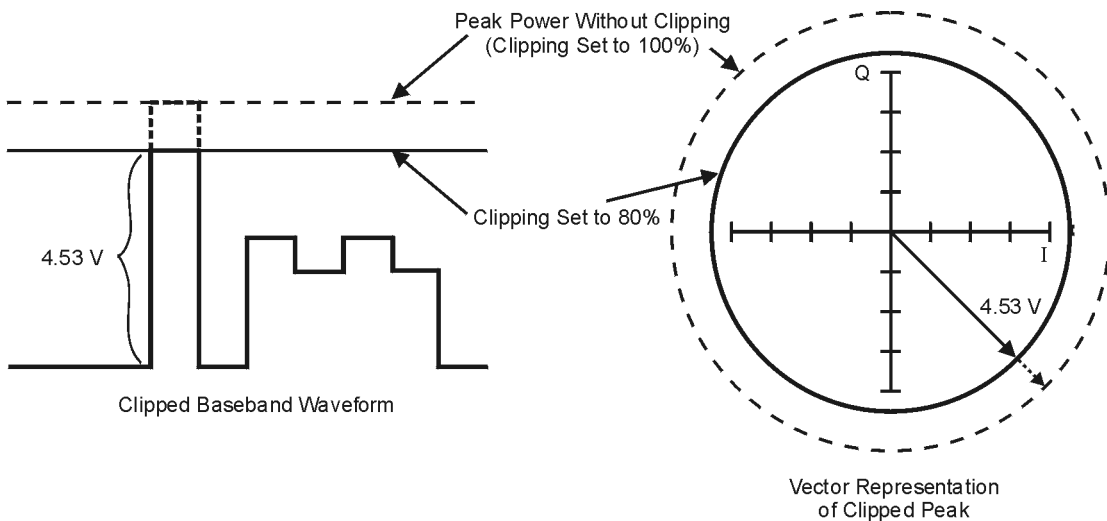

Figure 3-15 Rectangular Clipping

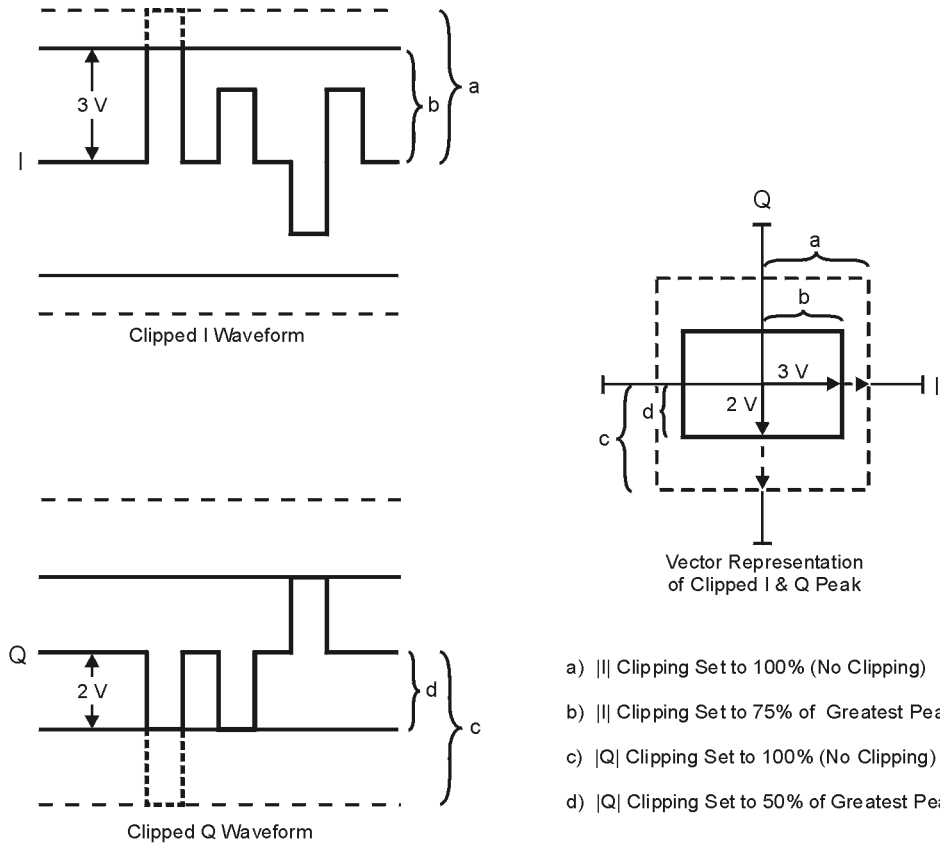
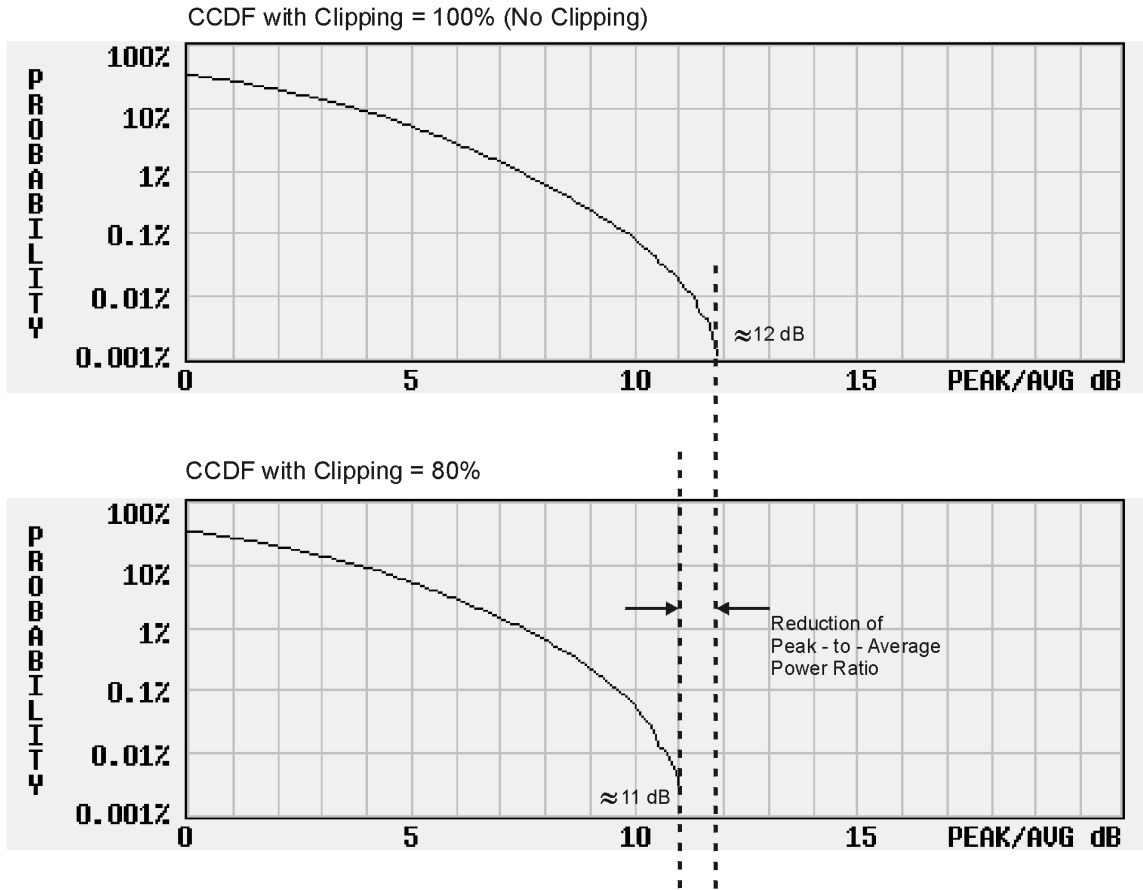

Figure 3-16 Reduction of Peak-to-Average Power

Complementary Cumulative Distribution



Configuring Circular Clipping

This procedure shows you how to configure circular clipping. The circular setting clips the composite I/Q data (I and Q data are clipped equally). For more information about circular clipping, refer to “How Clipping Reduces Peak-to-Average Power” on page 107.

1. Press **Preset > Mode > Custom > Arb Waveform Generator > Digital Modulation Off On** to On. This generates a custom arbitrary waveform for use in this procedure. You can also use a previously stored or downloaded waveform.

2. Press **Mode > Dual ARB > Select Waveform** and ensure that `AUTOGEN_WAVEFORM` is highlighted on the display. `AUTOGEN_WAVEFORM` is the default name assigned to the waveform you generated in the previous step.
3. Press **Select Waveform**. This selects the waveform and returns you to the previous softkey menu.
4. Press **ARB Off On to On**. The Dual Arb player must be turned on to display the CCDF plot in the following steps.
5. Press **ARB Setup > Waveform Utilities > Waveform Statistics** and ensure that `AUTOGEN_WAVEFORM` is highlighted on the display.
6. Press **CCDF Plot** and observe the position of the waveform's curve, which is the darkest line.
7. Press **Return > Return > Clipping**.
8. Ensure that the **Clipping Type $|I+jQ|$ $|I|,|Q|$** softkey is set to $|I+jQ|$, which is circular clipping.
9. Press **Clip $|I+jQ|$ To > 80 > % > Apply to Waveform**. The I and Q data are both clipped by 80%. Once clipping is applied to the waveform it cannot be undone. Repeated use of the clipping function has a cumulative effect on the waveform.
10. Press **Waveform Statistics > CCDF Plot** and observe the waveform's curve. Notice the reduction in peak-to-average power, relative to the previous plot, after applying clipping.

Configuring Rectangular Clipping

This procedure shows you how to configure rectangular clipping. The rectangular setting clips the I and Q data independently. For more information about rectangular clipping, refer to [“How Clipping Reduces Peak-to-Average Power” on page 107](#).

1. Press **Preset > Mode > Custom > Arb Waveform Generator > Digital Modulation Off On to On**. This generates a custom arbitrary waveform for use in this procedure. You can also use a previously stored or downloaded waveform.
2. Press **Mode > Dual ARB > Select Waveform** and ensure that `AUTOGEN_WAVEFORM` is highlighted on the display. `AUTOGEN_WAVEFORM` is the default name assigned to the waveform you generated in the previous step.
3. Press **Select Waveform**. This selects the waveform and returns you to the previous softkey menu.
4. Press **ARB Off On to On**. The Dual Arb player must be turned on to display the CCDF plot in the following steps.
5. Press **ARB Setup > Waveform Utilities > Waveform Statistics** and ensure that `AUTOGEN_WAVEFORM` is highlighted on the display.
6. Press **CCDF Plot** and observe the position of the waveform's curve, which is the darkest line.
7. Press **Return > Return > Clipping**.
8. Ensure that the **Clipping Type $|I+jQ|$ $|I|,|Q|$** softkey is set to $|I|,|Q|$. This activates the **Clip $|I|$ To** and **Clip $|Q|$ To** softkeys that enable you to configure rectangular (independent) I and Q data clipping.
9. Press **Clip $|I|$ To > 80 > %**.
10. Press **Clip $|Q|$ To > 40 > % > Apply to Waveform**. The I and Q data are individually clipped by 80% and 40%, respectively. Once clipping is applied to the waveform it cannot be undone. Repeated use of the clipping function has a cumulative effect on the waveform.

11. Press **Waveform Statistics > CCDF Plot** and observe the waveform's curve. Notice the reduction in peak-to-average power, relative to the previous plot, after applying clipping.

Using Waveform Scaling

Waveform scaling is used to eliminate DAC over-range errors. The PSG provides two methods of waveform scaling. You can perform runtime scaling, which enables you to make real-time scaling adjustments of a currently playing waveform, or you can permanently scale a non-playing waveform file residing in volatile memory. This section describes how DAC over-range errors occur and how you can use waveform scaling to eliminate these errors effectively.

The scaling feature is available only with the Dual ARB mode.

How DAC Over-Range Errors Occur

The PSG utilizes an interpolator filter in the conversion of the digital I and Q baseband waveforms into analog waveforms. The clock rate of the interpolator is four times that of the baseband clock. The interpolator therefore calculates sample points between the incoming baseband samples to equal the faster clock rate and smooth out the waveform, giving it a more curve-like appearance (see [Figure 3-17](#)).

Figure 3-17

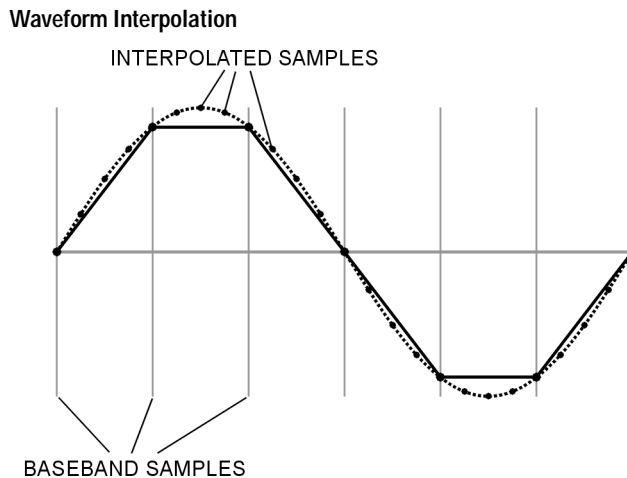

The interpolation filters in the DAC's have overshoot. If a baseband waveform has a fast-rising edge, the interpolator filter's overshoot or frequency response becomes a component of the interpolated baseband waveform. This response causes a ripple or ringing effect at the peak of the rising edge. If this ripple exceeds (or overshoots) the upper limit of the DAC's range, the interpolator calculates erroneous sample points and is unable to replicate the true form of the ripple (see [Figure 3-18](#)). As a result, the PSG reports a DAC over-range error.

Figure 3-18 Waveform Overshoot

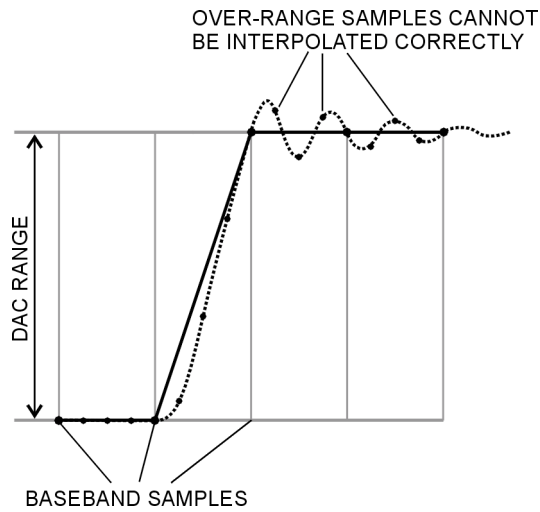

How Scaling Eliminates DAC Over-Range Errors

Scaling reduces or shrinks a baseband waveform's amplitude while maintaining its basic shape and characteristics, such as peak-to-average power ratio. If the fast-rising baseband waveform is scaled enough to allow an adequate margin for the overshoot, the interpolator filter is then able to calculate sample points that include the ripple effect, thereby eliminating the over-range error (see [Figure 3-19](#)).

Figure 3-19 Waveform Scaling

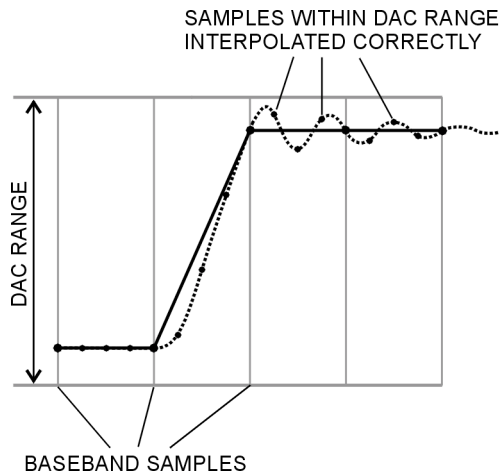

Although scaling maintains the basic shape of the waveform, too much scaling can compromise its integrity because the bit resolution can be so low that the waveform becomes corrupted with quantization noise. Maximum accuracy and optimum dynamic range are achieved by scaling the waveform just enough to remove the DAC over-range error. Optimum scaling varies with waveform content.

Scaling a Currently Playing Waveform (Runtime Scaling)

This procedure enables you to make real-time scaling adjustments to a currently playing waveform. This type of scaling does not affect the waveform file and is well suited for eliminating DAC over-range errors.

1. Press **Preset > Mode > Custom > Arb Waveform Generator > Digital Modulation Off On** to **On**. This generates a custom arbitrary waveform for use in this procedure. You can also use a previously stored or downloaded waveform.
2. Press **Mode > Dual ARB > Select Waveform** and ensure that **AUTOGEN_WAVEFORM** is highlighted on the display. **AUTOGEN_WAVEFORM** is the default name assigned to the waveform you generated in the previous step.
3. Press **Select Waveform**. This selects the waveform and returns you to the previous softkey menu.
4. Press **ARB Off On** to **On**. This plays the selected waveform.
5. Press **ARB Setup > More (1 of 2) > Waveform Runtime Scaling** and adjust the front panel knob or use the number keys to enter a new value. The new scaling value is instantly applied to the playing waveform. Runtime scaling adjustments are not cumulative, as the values are always relative to original amplitude of the waveform file.

Scaling a Waveform File in Volatile Memory

This procedure enables you to permanently scale a waveform file. You can then store the scaled waveform segment to non-volatile memory for future use. Scaling is cumulative and non-reversible.

1. Press **Preset > Mode > Custom > Arb Waveform Generator > Digital Modulation Off On** to **On**. This generates a custom arbitrary waveform for use in this procedure. You can also use a previously stored or downloaded waveform.
2. Press **Mode > Dual ARB > Select Waveform** and ensure that **AUTOGEN_WAVEFORM** is highlighted on the display. **AUTOGEN_WAVEFORM** is the default name assigned to the waveform you generated in the previous step.
3. Press **Select Waveform**. This selects the waveform and returns you to the previous softkey menu.
4. Press **ARB Setup > Waveform Utilities** and ensure that **AUTOGEN_WAVEFORM** is highlighted on the display.
5. Press **Scale Waveform Data > Scaling > 70 > % > Apply to Waveform**. The waveform is now reduced to 70 percent of its original amplitude. Once this type of scaling is applied to the waveform it cannot be undone. Repeated scaling applications have a cumulative effect on the waveform.

4 Optimizing Performance

In the following sections, this chapter describes procedures that improve the performance of the Agilent PSG signal generator.

- “Using the ALC” on page 115
- “Using External Leveling” on page 116
- “Creating and Applying User Flatness Correction” on page 119
- “Adjusting Reference Oscillator Bandwidth (Option UNR/UNX)” on page 130

Using the ALC

Selecting ALC Bandwidth

For internal leveling, the signal generator uses automatic leveling control (ALC) circuitry prior to the RF output. ALC bandwidth has five selections: automatic, 100 Hz, 1 kHz, 10 kHz, and 100 kHz. In automatic mode (the preset selection), the signal generator automatically selects the ALC bandwidth depending on the configuration and settings (see [Figure 4-1](#)).

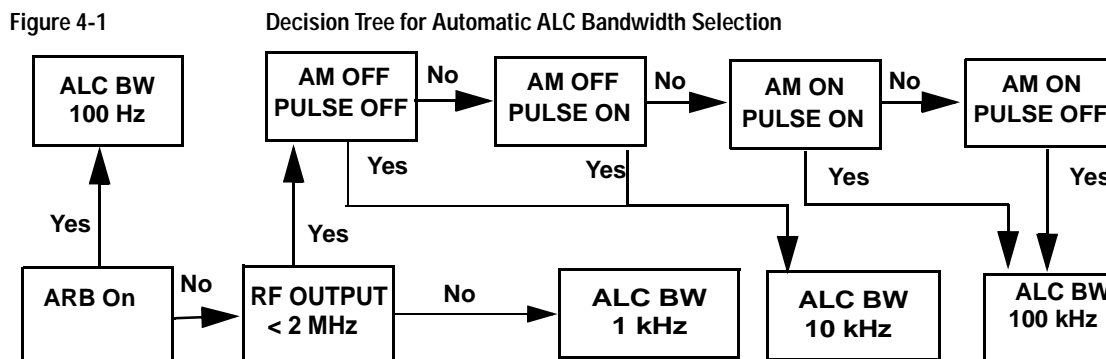

To Select an ALC Bandwidth

Press **Amplitude > ALC BW > 100 Hz, 1 kHz, 10 kHz, or 100 kHz**.

This overrides the signal generator’s automatic ALC bandwidth selection with your specific selection.

For waveforms with varying amplitudes, high crest factors, or both, the recommended ALC loop bandwidth is 100 Hz. Limiting the loop bandwidth of the ALC circuit will prevent the ALC from

sampling the fast rising edges of pulsed waveforms with high crest factors found in formats such as 802.11b, CDMA, and OFDM. A limited, or narrow bandwidth will result in a longer ALC sample time and a more accurate representation of the signal's level.

NOTE Do not use the 10 kHz ALC bandwidth for any I/Q modulated signal, as the ALC integration time is too short. For CW signals, you can use higher ALC bandwidths.

Using External Leveling

The PSG signal generator can be externally leveled by connecting an external sensor at the point where leveled RF output power is desired. This sensor detects changes in RF output power and returns a compensating voltage to the signal generator's ALC input. The ALC circuitry raises or lowers (levels) the RF output power based on the voltage received from the external sensor, ensuring constant power at the point of detection.

There are two types of external leveling available on the PSG. You can use external leveling with a detector and coupler/power splitter setup, or a millimeter-wave source module.

To Level with Detectors and Couplers/Splitters

Figure 4-2 illustrates a typical external leveling setup. The power level feedback to the ALC circuitry is taken from the external negative detector, rather than the internal signal generator detector. This feedback voltage controls the ALC system, leveling the RF output power at the point of detection.

To use detectors and couplers/splitters for external leveling at an RF output frequency of 10 GHz and an amplitude of 0 dBm, follow the instructions in this section.

Required Equipment

- Agilent 8474E negative detector
- Agilent 87301D directional coupler
- cables and adapters, as required

Connect the Equipment

Set up the equipment as shown in Figure 4-2.

Figure 4-2 External Detector Leveling with a Directional Coupler

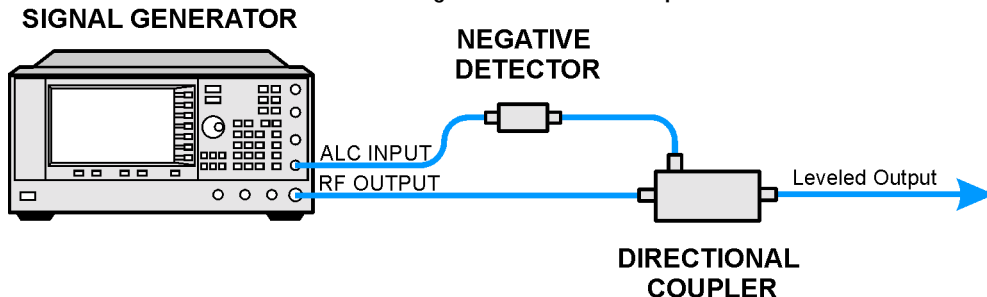

Configure the Signal Generator

1. Press **Preset**.
2. Press **Frequency > 10 > GHz**.
3. Press **Amplitude > 0 > dBm**.
4. Press **RF On/Off**.
5. Press **Leveling Mode > Ext Detector**.

This deactivates the internal ALC detector and switches the ALC input path to the front panel ALC INPUT connector. The EXT indicator is activated in the AMPLITUDE area of the display.

NOTE For signal generators with Option 1E1, notice that the ATTN HOLD (attenuator hold) annunciator is displayed. During external leveling, the signal generator automatically uncouples the attenuator from the ALC system for *all* external leveling points. While in this mode, the RF output amplitude adjustment is limited to -20 to +25 dBm, the adjustment range of the ALC circuitry. For more information, see [“External Leveling with Option 1E1 Signal Generators” on page 118](#).

6. Observe the coupling factor printed on the directional coupler at the detector port. Typically, this value is -10 to -20 dB.

Enter the *positive* dB value of this coupling factor into the signal generator.

7. Press **More (1 of 2) > Ext Detector Coupling Factor > 16** (or the positive representation of the value listed at the detector port of the directional coupler) > **dB**.

Leveled output power is now available at the output of the directional coupler.

NOTE While operating in external leveling mode, the signal generator’s displayed RF output amplitude is affected by the coupling factor value, resulting in a calculated approximation of the actual RF output amplitude. To determine the actual RF output amplitude at the point of detection, measure the voltage at the external detector output and refer to [Figure 4-3](#) or measure the power directly with a power meter.

Determining the Leveled Output Power

[Figure 4-3](#) shows the input power versus output voltage characteristics for typical Agilent Technologies diode detectors. Using this chart, you can determine the leveled power at the diode detector input by measuring the external detector output voltage. You must then add the coupling factor to determine the leveled output power. The range of power adjustment is approximately -20 to +25 dBm.

Figure 4-3 Typical Diode Detector Response at 25° C

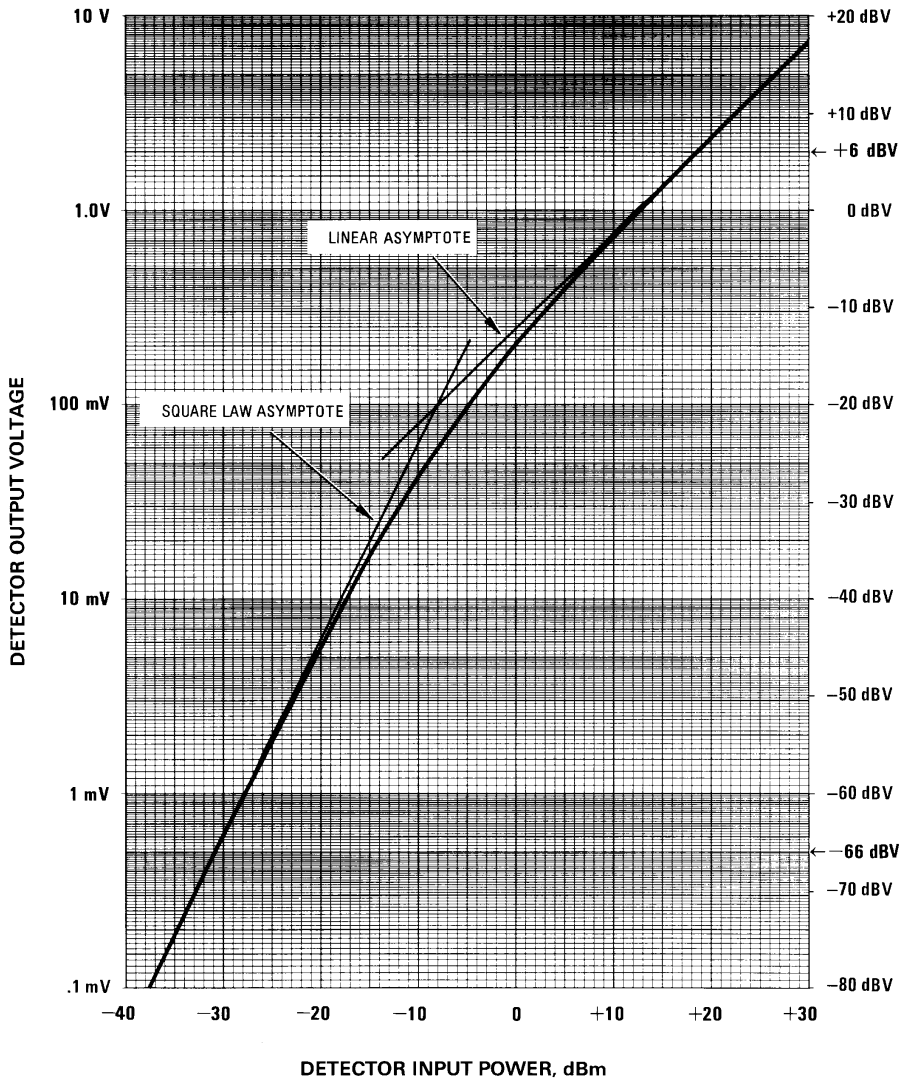

External Leveling with Option 1E1 Signal Generators

Signal generators with Option 1E1 contain a step attenuator prior to the RF output connector. During external leveling, the signal generator automatically holds the present attenuator setting (to avoid power transients that may occur during attenuator switching) as the RF amplitude is changed. A balance must be maintained between the amount of attenuation and the optimum ALC level to achieve the required RF output amplitude. For optimum accuracy and minimum noise, the ALC level should be greater than -10 dBm.

For example, leveling the CW output of a 30 dB gain amplifier to a level of -10 dBm requires the output of the signal generator to be approximately -40 dBm when leveled. This is beyond the amplitude limits of the ALC modulator alone, resulting in an unleveled RF output. Inserting 45 dB of attenuation results in an ALC level of +5 dBm, well within the range of the ALC modulator.

NOTE In the example above, 55 dB is the preferred attenuation choice, resulting in an ALC level of +15 dBm. This provides adequate dynamic range for AM or other functions that vary the RF output amplitude.

To achieve the optimum ALC level at the signal generator RF output of -40 dBm for an unmodulated carrier, follow these steps:

1. Press **Amplitude > Set Atten > 45 > dB**.
2. Press **Set ALC Level > 5 > dBm**.

This sets the attenuator to 45 dB and the ALC level to +5 dBm, resulting in an RF output amplitude of -40 dBm, as shown in the **AMPLITUDE** area of the display.

To obtain flatness-corrected power, refer to [“Creating and Applying User Flatness Correction” on page 119](#).

To Level with a mm-Wave Source Module

Millimeter-wave source module leveling is similar to external detector leveling. The power level feedback signal to the ALC circuitry is taken from the millimeter-wave source module, rather than the internal signal generator detector. This feedback signal levels the RF output power at the mm-wave source module output through the signal generator’s rear panel **SOURCE MODULE** interface connector.

For instructions and setups, see [Chapter 11, “Peripheral Devices,” on page 197](#).

Creating and Applying User Flatness Correction

User flatness correction allows the digital adjustment of RF output amplitude for up to 1601 frequency points in any frequency or sweep mode. Using an Agilent E4416A/17A or E4418B/19B power meter (controlled by the signal generator through GPIB) to calibrate the measurement system, a table of power level corrections is created for frequencies where power level variations or losses occur. These frequencies may be defined in sequential linear steps or arbitrarily spaced.

To allow different correction arrays for different test setups or different frequency ranges, you may save individual user flatness correction tables to the signal generator’s memory catalog and recall them on demand.

Use the steps in the next sections to create and apply user flatness correction to the signal generator’s RF output.

Afterward, use the steps in [“Recalling and Applying a User Flatness Correction Array” on page 123](#) to recall a user flatness file from the memory catalog and apply it to the signal generator’s RF output.

Creating a User Flatness Correction Array

In this example, you create a user flatness correction array. The flatness correction array contains ten frequency correction pairs (amplitude correction values for specified frequencies), from 1 to 10 GHz in 1 GHz intervals.

An Agilent E4416A/17A/18B/19B power meter (controlled by the signal generator via GPIB) and E4413A power sensor are used to measure the RF output amplitude at the specified correction frequencies and transfer the results to the signal generator. The signal generator reads the power level data from the power meter, calculates the correction values, and stores the correction pairs in a user flatness correction array.

If you do not have the required Agilent power meter, or if your power meter does not have a GPIB interface, you can enter correction values manually.

Required Equipment

- Agilent E4416A/17A/18B/19B power meter
- Agilent E4413A E Series CW power sensor
- GPIB interface cable
- adapters and cables, as required

NOTE If the setup has an external leveling configuration, the equipment setup in [Figure 4-4](#) assumes that the steps necessary to correctly level the RF output have been followed. If you have questions about external leveling, refer to [“Using External Leveling” on page 116](#).

Configure the Power Meter

1. Select SCPI as the remote language for the power meter.
2. Zero and calibrate the power sensor to the power meter.
3. Enter the appropriate power sensor calibration factors into the power meter as appropriate.
4. Enable the power meter's cal factor array.

NOTE For operating information on a particular power meter/sensor, refer to its operating guide.

Connect the Equipment

Connect the equipment as shown in [Figure 4-4](#).

NOTE During the process of creating the user flatness correction array, the power meter is slaved to the signal generator via GPIB. No other controllers are allowed on the GPIB interface.

Figure 4-4

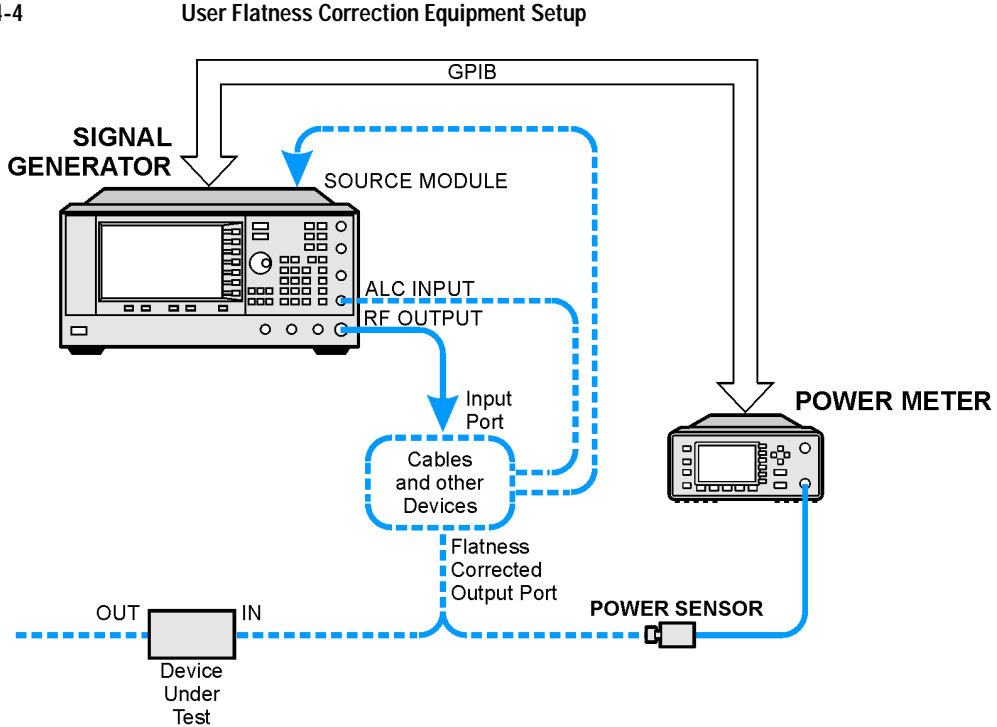

Configure the Signal Generator

1. Press **Preset**.
2. Configure the signal generator to interface with the power meter.
 - a. Press **Amplitude > More (1 of 2) > User Flatness > More (1 of 2) > Power Meter > E4416A, E4417A, E4418B, or E4419B**.
 - b. Press **Meter Address > enter the power meter's GPIB address > Enter**.
 - c. For E4417A and E4419B models, press **Meter Channel A B** to select the power meter's active channel.
 - d. Press **Meter Timeout** to adjust the length of time before the instrument generates a timeout error if unsuccessfully attempting to communicate with the power meter.
3. Press **More (2 of 2) > Configure Cal Array > More (1 of 2) > Preset List > Confirm Preset**.
This opens the User Flatness table editor and presets the cal array frequency/correction list.
4. Press **Configure Step Array**.
This opens a menu for entering the user flatness step array data.
5. Press **Freq Start > 1 > GHz**.
6. Press **Freq Stop > 10 > GHz**.

7. Press **# of Points > 10 > Enter**.

Steps 4, 5, and 6 enter the desired flatness-corrected frequencies into the step array.

8. Press **Return > Load Cal Array From Step Array > Confirm Load From Step Data**.

This populates the user flatness correction array with the frequency settings defined in the step array.

9. Press **Amplitude > More (1 of 2) > Ampl Offset**.

Enter a nominal (average) value for the gain or loss of any cables or other devices connected between the signal generator's RF output and the power sensor. Refer to figure [Figure 4-4 on page 121](#). Gain is entered as a positive number while loss is entered as a negative number.

10. Press **RF On/Off**.

This activates the RF output and the RF ON annunciator is displayed on the signal generator.

Perform the User Flatness Correction

NOTE If you are not using an Agilent E4416A/17A/18B/19B power meter, or if your power meter does not have a GPIB interface, you can perform the user flatness correction manually. For instructions, see [“Performing the User Flatness Correction Manually” on page 122](#).

1. Press **More (1 of 2) > User Flatness > Do Cal**.

Pressing the **Do Cal** softkey causes the signal generator to perform the user flatness correction routine. A progress bar is shown on the front panel display as the routine runs. The routine generates a table of correction points with each correction point consisting of a frequency and amplitude correction value for that frequency. The correction value at each point is the difference between the power level, as measured by the power meter, and the output power of the signal generator.

NOTE A power meter timeout may occur at low power levels. If a power meter timeout error message appears, increase the timeout value by pressing **Amplitude > More (1 of 2) > User Flatness > More (1 of 2) > Meter Timeout**.

2. Press **Done**.

Pressing the **Done** softkey loads the amplitude correction values into the user flatness correction array.

If desired, press **Configure Cal Array**.

This opens the user flatness correction array, where you can view the stored amplitude correction values. The user flatness correction array title displays **User Flatness: (UNSTORED)** indicating that the current user flatness correction array data has not been saved to the memory catalog.

Performing the User Flatness Correction Manually

If you are not using an Agilent E4416A/17A/18B/19B power meter, or if your power meter does not have a GPIB interface, complete the steps in this section and then continue with the user flatness correction tutorial.

1. Press **More (1 of 2) > User Flatness > Configure Cal Array**.

This opens the User Flatness table editor and places the cursor over the frequency value (1 GHz) for row 1. The RF output changes to the frequency value of the table row containing the cursor and 1.000 000 000 00 is displayed in the AMPLITUDE area of the display.

2. Observe and record the measured value from the power meter.
3. Subtract the measured value from 0 dBm.
4. Move the table cursor over the correction value in row 1.
5. Press **Edit Item >** enter the difference value from step 3 **> dB**.

The signal generator adjusts the RF output amplitude based on the correction value entered.

6. Repeat steps 2 through 5 until the power meter reads 0 dBm.
7. Use the down arrow key to place the cursor over the frequency value for the next row. The RF output changes to the frequency value of the table row containing the cursor, as shown in the AMPLITUDE area of the display.
8. Repeat steps 2 through 7 for every entry in the User Flatness table.

Save the User Flatness Correction Data to the Memory Catalog

This process allows you to save the user flatness correction data as in the signal generator's memory catalog. With several user flatness correction files saved to the memory catalog, any file can be recalled, loaded into the correction array, and applied to the RF output to satisfy specific RF output flatness requirements.

1. Press **Load/Store**.
2. Press **Store to File**.
3. Enter the file name **FLATCAL1** using the alphanumeric softkeys, numeric keypad, or the knob.
4. Press **Enter**.

The user flatness correction array file **FLATCAL1** is now stored in the memory catalog as a **UFLT** file.

Applying a User Flatness Correction Array

Press **Return > Return > Flatness Off On** to **On**.

This applies the user flatness correction array to the RF output. The **UF** indicator is activated in the **AMPLITUDE** section of the signal generator's display and the frequency correction data contained in the correction array is applied to the RF output amplitude.

Recalling and Applying a User Flatness Correction Array

Before performing the steps in this section, complete [“Creating a User Flatness Correction Array” on page 120](#).

1. Press **Preset**.
2. Press **Amplitude > More (1 of 2) > User Flatness > Configure Cal Array > More (1 of 2) > Preset List > Confirm Preset**.
3. Press **More (2 of 2) > Load/Store**.

4. Ensure that the file `FLATCAL1` is highlighted.
5. Press **Load From Selected File** > **Confirm Load From File**.

This populates the user flatness correction array with the data contained in the file `FLATCAL1`. The user flatness correction array title displays `User Flatness: FLATCAL1`.

6. Press **Return** > **Flatness Off On** to **On**.

This applies the user flatness correction data contained in `FLATCAL1`.

Returning the Signal Generator to GPIB Listener Mode

During the user flatness correction process, the power meter is slaved to the signal generator via GPIB, and no other controllers are allowed on the GPIB interface. The signal generator operates in GPIB talker mode, as a device controller for the power meter. In this operating mode, it cannot receive SCPI commands via GPIB.

If the signal generator is to be interfaced to a remote controller after performing the user flatness correction, its GPIB controller mode must be changed from GPIB talker to GPIB listener.

If an RF carrier has been previously configured, you must save the present instrument state before returning the signal generator to GPIB listener mode.

1. Save your instrument state to the instrument state register.

For instructions, see [“Saving an Instrument State” on page 53](#).

2. Press **Amplitude** > **More (1 of 2)** > **User Flatness** > **GPIB Listener Mode**.

This presets the signal generator and returns it to GPIB listener mode. The signal generator can now receive remote commands executed by a remote controller connected to the GPIB interface.

3. Recall your instrument state from the instrument state register.

For instructions, see [“Saving an Instrument State” on page 53](#).

Creating a User Flatness Correction Array with a mm-Wave Source Module

In this example, a user flatness correction array is created to provide flatness-corrected power at the output of an Agilent 83554A millimeter-wave source module driven by an E8257D signal generator.

The flatness correction array contains 28 frequency correction pairs (amplitude correction values for specified frequencies), from 26.5 to 40 GHz in 500 MHz intervals. This will result in 28 evenly spaced flatness corrected frequencies between 26.5 GHz and 40 GHz at the output of the 83554A millimeter-wave source module.

An Agilent E4416A/17A/18B/19B power meter (controlled by the signal generator via GPIB) and R8486A power sensor are used to measure the RF output amplitude of the millimeter-wave source module at the specified correction frequencies and transfer the results to the signal generator. The signal generator reads the power level data from the power meter, calculates the correction values, and stores the correction pairs in the user flatness correction array.

If you do not have the required Agilent power meter, or if your power meter does not have a GPIB interface, you can enter correction values manually.

NOTE User Flatness correction is only applicable for Agilent 83550 series mm-wave source modules and does not function with other mm-wave modules such as OML modules.

Required Equipment

- Agilent 83554A millimeter-wave source module
- Agilent E4416A/17A/18B/19B power meter
- Agilent R8486A power sensor
- Agilent 8349B microwave amplifier (required for signal generators without Option 1EA)
- GPIB interface cable
- adapters and cables as required

NOTE The equipment setups in [Figure 4-5](#) and [Figure 4-6](#) assume that the steps necessary to correctly level the RF output have been followed. If you have questions about leveling with a millimeter-wave source module, refer to [“To Level with a mm-Wave Source Module” on page 119](#).

Configure the Power Meter

1. Select SCPI as the remote language for the power meter.
2. Zero and calibrate the power sensor to the power meter.
3. Enter the appropriate power sensor calibration factors into the power meter as appropriate.
4. Enable the power meter’s cal factor array.

NOTE For operating information on your particular power meter/sensor, refer to their operating guides.

Connect the Equipment

CAUTION To prevent damage to the signal generator, turn off the line power to the signal generator before connecting the source module interface cable to the rear panel SOURCE MODULE interface connector.

1. Turn off the line power to the signal generator.
2. Connect the equipment. For standard signal generators, use the setup in [Figure 4-5](#). For Option 1EA signal generators, use the setup in [Figure 4-6](#).

NOTE During the process of creating the user flatness correction array, the power meter is slaved to the signal generator via GPIB. No other controllers are allowed on the GPIB interface.

Figure 4-5 User Flatness with mm-Wave Source Module for a Signal Generator without Option 1EA

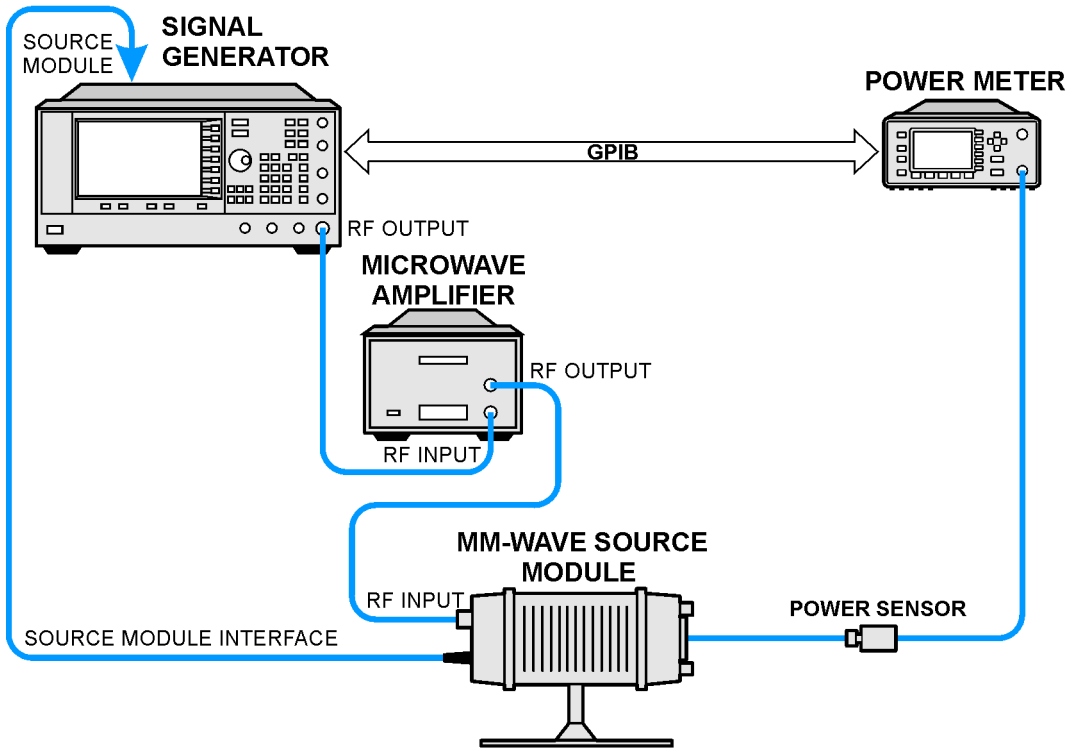
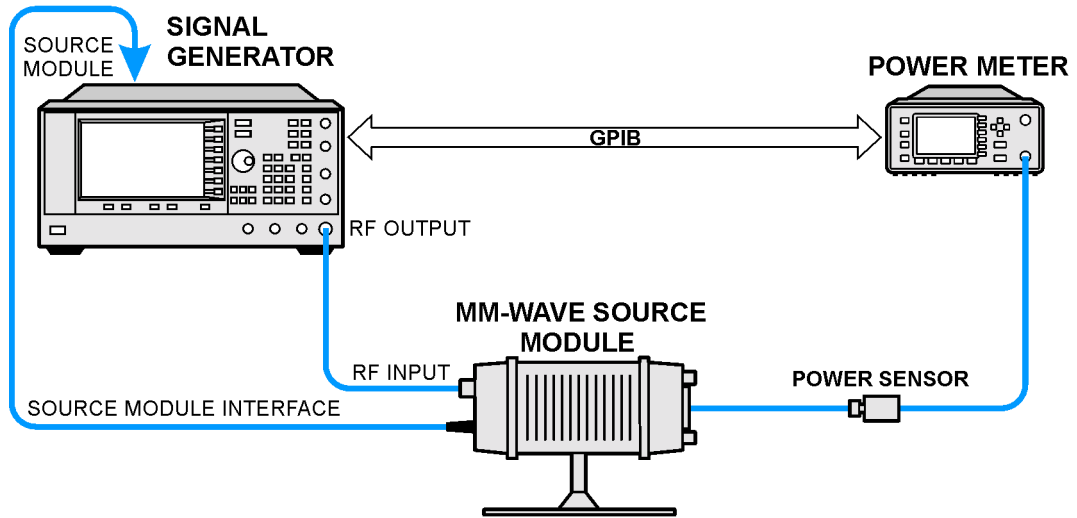

Figure 4-6 User Flatness with mm-Wave Source Module and Option 1EA Signal Generator



pe920a

NOTE To ensure adequate RF amplitude at the mm-wave source module RF input when using Option 1EA signal generators, maximum amplitude loss through the adapters and cables connected between the signal generator's RF output and the mm-wave source module's RF input should be less than 1.5 dB.

Configure the Signal Generator

1. Turn on the signal generator's line power. At power-up, the signal generator automatically does the following:
 - senses the mm-wave source module
 - switches the signal generator's leveling mode to external/source module
 - sets the mm-wave source module frequency and amplitude to the source module's preset values
 - displays the RF output frequency and amplitude available at the mm-wave source module output

The **MMOD** indicator in the **FREQUENCY** area and the **MM** indicator in the **AMPLITUDE** area of the signal generator's display indicate that the mm-wave source module is active

NOTE For specific frequency/amplitude ranges, see the mm-wave source module specifications.

2. Configure the signal generator to interface with the power meter.
 - a. Press **Amplitude > More (1 of 2) > User Flatness > More (1 of 2) > Power Meter > E4416A, E4417A, E4418B, or E4419B**.
 - b. Press **Meter Address >** enter the power meter's GPIB address **> Enter**.
 - c. For E4417A and E4419B models, press **Meter Channel A B** to select the power meter's active channel.
 - d. Press **Meter Timeout** to adjust the length of time before the instrument generates a timeout error if unsuccessfully attempting to communicate with the power meter.
3. Press **More (2 of 2) > Configure Cal Array > More (1 of 2) > Preset List > Confirm Preset**.

This opens the User Flatness table editor and resets the cal array frequency/correction list.
4. Press **Configure Step Array**.

This opens a menu for entering the user flatness step array data.
5. Press **Freq Start > 26.5 > GHz**.
6. Press **Freq Stop > 40 > GHz**.
7. Press **# of Points > 28 > Enter**.

This enters the desired flatness-corrected frequencies (26.5 GHz to 40 GHz in 500 MHz intervals) into the step array.
8. Press **Return > Load Cal Array From Step Array > Confirm Load From Step Data**.

This populates the user flatness correction array with the frequency settings defined in the step array.
9. Press **Amplitude > 0 > dBm**.
10. Press **RF On/Off**.

This activates the RF output and the RF ON annunciator is displayed on the signal generator.

Perform the User Flatness Correction

NOTE If you are not using an Agilent E4416A/17A/18B/19B power meter, or if your power meter does not have a GPIB interface, you can perform the user flatness correction manually. For instructions, see [Performing the User Flatness Correction Manually](#) below.

1. Press **More (1 of 2) > User Flatness > Do Cal**.

This creates the user flatness amplitude correction value table entries. The signal generator begins the user flatness correction routine and a progress bar is shown on the display.
2. When prompted, press **Done**.

This loads the amplitude correction values into the user flatness correction array.

If desired, press **Configure Cal Array**.

This opens the user flatness correction array, where you can view the list of defined frequencies and their calculated amplitude correction values. The user flatness correction array title displays

User Flatness: (UNSTORED) indicating that the current user flatness correction array data has not been saved to the memory catalog.

Performing the User Flatness Correction Manually

If you are not using an Agilent E4416A/17A/18B/19B power meter, or if your power meter does not have a GPIB interface, complete the steps in this section and then continue with the user flatness correction tutorial.

1. Press **More (1 of 2) > User Flatness > Configure Cal Array**.

This opens the User Flatness table editor and places the cursor over the frequency value (26.5 GHz) for row 1. The RF output changes to the frequency value of the table row containing the cursor and 26.500 000 000 00 is displayed in the **AMPLITUDE** area of the display.

2. Observe and record the measured value from the power meter.
3. Subtract the measured value from 0 dBm.
4. Move the table cursor over the correction value in row 1.
5. Press **Edit Item >** enter the difference value from step 3 **> dB**.
The signal generator adjusts the RF output amplitude based on the correction value entered.
6. Repeat steps 2 through 5 until the power meter reads 0 dBm.
7. Use the down arrow key to place the cursor over the frequency value for the next row. The RF output changes to the frequency value highlighted by the cursor, as shown in the **AMPLITUDE** area of the display.
8. Repeat steps 2 through 7 for each entry in the User Flatness table.

Save the User Flatness Correction Data to the Memory Catalog

This process allows you to save the user flatness correction data as a file in the signal generator's memory catalog. With several user flatness correction files saved to the memory catalog, specific files can be recalled, loaded into the correction array, and applied to the RF output to satisfy various RF output flatness requirements.

1. Press **Load/Store**.
2. Press **Store to File**.
3. Enter the file name **FLATCAL2** using the alphanumeric softkeys and the numeric keypad.
4. Press **Enter**.

The user flatness correction array file **FLATCAL2** is now stored in the memory catalog as a **UFLT** file.

Applying the User Flatness Correction Array

1. Press **Return > Return > Flatness Off On**.

This applies the user flatness correction array to the RF output. The **UF** indicator is activated in the **AMPLITUDE** section of the signal generator's display and the frequency correction data contained in the correction array is applied to the RF output amplitude of the mm-wave source module.

Recalling and Applying a User Flatness Correction Array

Before performing the steps in this section, complete the section “[Creating a User Flatness Correction Array with a mm-Wave Source Module](#)” on page 124.

1. Press **Preset**.
2. Press **Amplitude > More (1 of 2) > User Flatness > Configure Cal Array > More (1 of 2) > Preset List > Confirm Preset**.
3. Press **More (2 of 2) > Load/Store**.
4. Ensure that the file `FLATCAL2` is highlighted.
5. Press **Load From Selected File > Confirm Load From File**.

This populates the user flatness correction array with the data contained in the file `FLATCAL2`. The user flatness correction array title displays `User Flatness: FLATCAL2`.

6. Press **Return > Flatness Off On**.

This activates flatness correction using the data contained in the file `FLATCAL2`.

Adjusting Reference Oscillator Bandwidth (Option UNR/UNX)

The reference oscillator bandwidth (sometimes referred to as loop bandwidth) in signal generators with Option UNR/UNX (improved close-in phase noise < 1 kHz) is adjustable in fixed steps for either an internal or external 10 MHz frequency reference. The reference oscillator bandwidth can be set to 25, 55, 125, 300, or 650 Hz; models without Option UNR/UNX have a fixed reference oscillator bandwidth of about 15 Hz.

At frequency offsets below approximately 1 kHz, the stability and phase noise are determined by the internal or external frequency reference. At frequency offsets above 1 kHz, stability and phase noise are determined by the synthesizer hardware.

To optimize the overall phase noise performance of the signal generator for your particular application, make this adjustment depending on your confidence in the stability and phase noise of the external or internal reference versus the synthesizer hardware for various frequency offsets from the carrier.

To Select the Reference Oscillator Bandwidth

When using the internal timebase reference:

1. Press **Utility > Instrument Adjustments > Reference Oscillator Adjustment > Internal Ref Bandwidth**.
2. Select the desired bandwidth.

When using an external timebase reference:

1. Press **Utility > Instrument Adjustments > Reference Oscillator Adjustment > External Ref Bandwidth**.
2. Select the desired bandwidth.

To Restore Factory Default Settings:

Internal Timebase: 125 Hz
External Timebase: 25 Hz

Press **Utility** > **Instrument Adjustments** > **Reference Oscillator Adjustment** > **Restore Factory Defaults**.

5 Analog Modulation

In the following sections, this chapter describes the standard continuous waveform and optional analog modulation capability in Agilent E8257D PSG Analog and E8267D PSG Vector signal generators.

- [“Analog Modulation Waveforms” on page 131](#)
- [“Configuring AM \(Option UNT\)” on page 132](#)
- [“Configuring FM \(Option UNT\)” on page 132](#)
- [“Configuring \$\Phi\$ M \(Option UNT\)” on page 133](#)
- [“Configuring Pulse Modulation \(Option UNU/UNW\)” on page 134](#)
- [“Configuring the LF Output \(Option UNT\)” on page 135](#)

Analog Modulation Waveforms

Available standard internal waveforms include:

Sine	sine wave with adjustable amplitude and frequency
Dual-Sine	dual-sine waves with individually adjustable frequencies and a percent-of-peak-amplitude setting for the second tone (available from function generator only)
Swept-Sine	swept-sine wave with adjustable start and stop frequencies, sweep rate, and sweep trigger settings (available from function generator only)
Triangle	triangle wave with adjustable amplitude and frequency
Ramp	ramp with adjustable amplitude and frequency
Square	square wave with adjustable amplitude and frequency
Noise	noise with adjustable amplitude generated as a peak-to-peak value (RMS value is approximately 80% of the displayed value)

With Option UNT, the signal generator can modulate the RF carrier with amplitude, frequency, or phase modulation. Option UNT also provides low-frequency output capability.

With Option UNU, the signal generator can modulate the RF carrier with standard pulse modulation (150 ns minimum pulse width).

With Option UNW, the signal generator can modulate the RF carrier with narrow pulse modulation (20 ns minimum pulse width).

Configuring AM (Option UNT)

In this example, you will learn how to generate an amplitude-modulated RF carrier.

To Set the Carrier Frequency

1. Press **Preset**.
2. Press **Frequency > 1340 > kHz**.

To Set the RF Output Amplitude

Press **Amplitude > 0 > dBm**.

To Set the AM Depth and Rate

1. Press the **AM** hardkey.
2. Press **AM Depth > 90 > %**.
3. Press **AM Rate > 10 > kHz**.

The signal generator is now configured to output a 0 dBm, amplitude-modulated carrier at 1340 kHz with the AM depth set to 90% and the AM rate set to 10 kHz. The shape of the waveform is a sine wave. Notice that sine is the default selection for the **AM Waveform** softkey, which can be viewed by pressing **(More 1 of 2)**.

To Turn on Amplitude Modulation

Follow these remaining steps to output the amplitude-modulated signal.

1. Press the **AM Off On** softkey to **On**.
2. Press the front panel **RF On Off** key.

The **AM** and **RF ON** annunciators are now displayed. This indicates that you have enabled amplitude modulation and the signal is now being transmitted from the **RF OUTPUT** connector.

Configuring FM (Option UNT)

In this example, you will learn how to create a frequency-modulated RF carrier.

To Set the RF Output Frequency

1. Press **Preset**.
2. Press **Frequency > 1 > GHz**.

To Set the RF Output Amplitude

Press **Amplitude > 0 > dBm**.

To Set the FM Deviation and Rate

1. Press the FM/ Φ M hardkey.
2. Press FM Dev > 75 > kHz.
3. Press FM Rate > 10 > kHz.

The signal generator is now configured to output a 0 dBm, frequency-modulated carrier at 1 GHz with a 75 kHz deviation and a 10 kHz rate. The shape of the waveform is a sine wave. (Notice that sine is the default for the FM Waveform softkey. Press More (1 of 2) to see the softkey.)

To Activate FM

1. Press FM Off On to On.
2. Press RF On/Off.

The FM and RF ON annunciators are now displayed. This indicates that you have enabled frequency modulation and the signal is now being transmitted from the RF OUTPUT connector.

DC Offset and External FM

Applying a DC offset to an external FM signal will shift the frequency of the FM signal above or below the carrier frequency, depending on the polarity of the DC level. The amount frequency shift is directly related to the amplitude of the DC level. A DC offset of +1.0 volt or greater will shift the external FM frequency by an amount equal to the maximum deviation setting. For example, if the signal generator CW frequency is 1 GHz and the maximum deviation setting is set to 100 kHz, an external DC-coupled signal with a +1.0 volt DC level used as the modulating source will center the FM signal at 1 GHz + 100 kHz. Keeping the same setup and settings and changing the DC level to +0.5 volts will center the FM signal at 1 GHz + 50 kHz.

Configuring Φ M (Option UNT)

In this example, you will learn how to create a phase-modulated RF carrier.

To Set the RF Output Frequency

1. Press Preset.
2. Press Frequency > 3 > GHz.

To Set the RF Output Amplitude

Press Amplitude > 0 > dBm.

To Set the Φ M Deviation and Rate

1. Press the FM/ Φ M hardkey.
2. Press the FM Φ M softkey.
3. Press Φ M Dev > .25 > pi rad.
4. Press Φ M Rate > 10 > kHz.

The signal generator is now configured to output a 0 dBm, phase-modulated carrier at 3 GHz with a 0.25 p radian deviation and 10 kHz rate. The shape of the waveform is a sine wave. (Notice that sine is the default for the Φ M Waveform softkey. Press **More (1 of 2)** to see the softkey.)

To Activate Φ M

1. Press Φ M Off On.
2. Press RF On/Off.

The Φ M and RF ON annunciators are now displayed. This indicates that you have enabled phase modulation and the signal is now being transmitted from the RF OUTPUT connector.

Configuring Pulse Modulation (Option UNU/UNW)

In this example, you will learn how to create a gated, pulse-modulated RF carrier with an external trigger.

To Set the RF Output Frequency

1. Press Preset.
2. Press Frequency > 2 > GHz.

To Set the RF Output Amplitude

Press Amplitude > 0 > dBm.

To Set the Pulse Period, Width, and Triggering

1. Press Pulse > Pulse Period > 100 > usec.
2. Press Pulse > Pulse Width > 24 > usec.
3. Press Pulse > Pulse Source > Int Gated.
4. Connect a TTL signal to the Trigger In connector on the rear panel of the signal generator. To configure the trigger signal polarity, Press Utility > Instrument Adjustments > Signal Polarity Setup > Trigger In Polarity.

The signal generator is now configured to output a 0 dBm, pulse-modulated carrier at 2 GHz with a 100-microsecond pulse period and 24-microsecond pulse width. The pulse source is set to internal gated. (Notice that Internal Free Run is the default for the Pulse Source softkey.)

To Activate Pulse Modulation

Follow these remaining steps to output the pulse-modulated signal.

1. Press Pulse Off On to On.
2. Press RF On/Off.

The Pulse and RF ON annunciators are now displayed. This indicates that you have enabled pulse modulation and the signal is now being transmitted from the RF OUTPUT connector. The TTL trigger signal state will control pulse modulation output.

Configuring the LF Output (Option UNT)

With Option UNT, the signal generator has a low frequency (LF) output (described on [page 10](#)). The LF output's source can be switched between **Internal 1 Monitor**, **Internal 2 Monitor**, **Function Generator 1**, or **Function Generator 2**.

Using **Internal 1 Monitor** or **Internal 2 Monitor** as the LF output source, the LF output provides a replica of the signal from the internal source that is being used to modulate the RF output. The specific modulation parameters for this signal are configured through the AM, FM, or FM menus.

Using **Function Generator 1** or **Function Generator 2** as the LF output source, the function generator section of the internal modulation source drives the LF output directly. Frequency and waveform are configured from the LF output menu, not through the AM, FM, or FM menus. You can select the waveform shape from the following choices:

Sine	sine wave with adjustable amplitude and frequency
Dual-Sine	dual-sine waves with individually adjustable frequencies and a percent-of-peak-amplitude setting for the second tone (available from function generator 1 only)
Swept-Sine	a swept-sine wave with adjustable start and stop frequencies, sweep rate, and sweep trigger settings (available from function generator 1 only)
Triangle	triangle wave with adjustable amplitude and frequency
Ramp	ramp with adjustable amplitude and frequency
Square	square wave with adjustable amplitude and frequency
Noise	noise with adjustable amplitude generated as a peak-to-peak value (RMS value is approximately 80% of the displayed value)
DC	direct current with adjustable amplitude

NOTE The **LF Out Off On** softkey controls the operating state of the LF output. However, when the LF output source selection is **Internal Monitor**, you have three ways of controlling the output. You can use the modulation source (AM, FM, or FM) on/off key, the LF output on/off key, or the **Mod On/Off** softkey.

The **RF On/Off** hardkey does not apply to the LF OUTPUT connector.

To Configure the LF Output with an Internal Modulation Source

In this example, the internal FM modulation is the LF output source.

NOTE Internal modulation (**Internal Monitor**) is the default LF output source.

Configuring the Internal Modulation as the LF Output Source

1. Press **Preset**.
2. Press the **FM/ΦM** hardkey.
3. Press **FM Dev > 75 > kHz**.
4. Press **FM Rate > 10 > kHz**.

5. Press **FM Off On**.

You have set up the FM signal with a rate of 10 kHz and 75 kHz of deviation. The FM annunciator is activated indicating that you have enabled frequency modulation.

Configuring the Low Frequency Output

1. Press the **LF Out** hardkey.
2. Press **LF Out Amplitude > 3 > Vp**.
3. Press **LF Out Off On**.

You have configured the LF output signal for a 3 volt sine wave (default wave form) output which is frequency modulated using the **Internal 1 Monitor** source selection (default source).

To Configure the LF Output with a Function Generator Source

In this example, the function generator is the LF output source.

Configuring the Function Generator as the LF Output Source

1. Press **Preset**.
2. Press the **LF Out** hardkey.
3. Press **LF Out Source > Function Generator 1**.

Configuring the Waveform

1. Press **LF Out Waveform > Swept-Sine**.
2. Press **LF Out Start Freq > 100 > Hz**.
3. Press **LF Out Stop Freq > 1 > kHz**.
4. Press **Return > Return**.

This returns you to the top LF Output menu.

Configuring the Low Frequency Output

1. Press **LF Out Amplitude > 3 > Vp**.

This sets the LF output amplitude to 3 Vp.

2. Press **LF Out Off On**.

The LF output is now transmitting a signal using Function Generator 1 that is providing a 3 Vp swept-sine waveform. The waveform is sweeping from 100 Hz to 1 kHz.

6 Custom Arb Waveform Generator

In the following sections, this chapter describes the custom arbitrary waveform generator mode, which is available only in E8267D PSG vector signal generators with Option 601 or 602:

- [“Overview” on page 137](#)
- [“Working with Predefined Setups \(Modes\)” on page 137](#)
- [“Working with Filters” on page 140](#)
- [“Working with Symbol Rates” on page 147](#)
- [“Working with Modulation Types” on page 149](#)
- [“Configuring Hardware” on page 155](#)

See also: [Chapter 3, “Basic Digital Operation,” on page 67](#)

Overview

Custom Arb Waveform Generator mode can produce a single modulated carrier or multiple modulated carriers. Each modulated carrier waveform must be calculated and generated before it can be output; this signal generation occurs on the internal baseband generator (Option 601 or 602). Once a waveform has been created, it can be stored and recalled which enables repeatable playback of test signals.

To begin using the Custom Arb Waveform Generator mode, select whether to create a single modulated carrier or a multiple modulated carrier waveform:

- If you want to create a single modulated carrier waveform, start by selecting a Digital Modulation Setup from a set of predefined modes (setups). Once a predefined mode is selected, you can modify the Modulation Type, the Filter being used, the Symbol Rate, and the type of Triggering; the Data Pattern is random by default. This modified setup can then be stored and reused.
- If you want to create a multiple modulated carrier waveform, start by selecting a Multicarrier Setup from a set of predefined modes (setups). Once a predefined mode is selected, you can modify the number of carriers to be created, the frequency spacing between each carrier, whether the phase offset between each carrier is to be fixed or random, and the type of Triggering; the Data Pattern is random by default, the Filter is set to 40 MHz by default, and the Symbol Rate is automatically specified by the selected Modulation Type being used.

Working with Predefined Setups (Modes)

When you select a predefined mode, default values for components of the setup (including the filter, symbol rate, and modulation type) are automatically specified.

Selecting a Custom ARB Setup or a Custom Digital Modulation State

1. Preset the signal generator: press **Preset**.
2. Press **Mode > Custom > Arb Waveform Generator > Setup Select**.
3. Select either:
 - one of the predefined modulation setups: **NADC, PDC, PHS, GSM, DECT, EDGE, APCO 25 w/C4FM, APCO 25 w/CQPSK, CDPD, PWT, or TETRA**
This selects a predefined setup where filtering, symbol rate, and modulation type are defined by the predefined modulation setup (mode) that you selected and returns you to the top-level custom modulation menu; it does not include bursting or channel coding.
or
 - **Custom Digital Mod State**
This selects a custom setup stored in the Catalog of DMOD Files (see [page 138](#) for information on creating a custom digital modulation setup).

Working with User-Defined Setups (Modes)–Custom Arb Only

Modifying a Single-Carrier NADC Setup

In this procedure, you learn how to start with a single-carrier NADC digital modulation and modify it to a custom waveform with customized modulation type, symbol rate, and filtering.

1. Press **Preset**.
2. Press **Mode > Custom > ARB Waveform Generator > Setup Select > NADC**.
3. Press **Digital Mod Define > Modulation Type > PSK > QPSK and OQPSK > QPSK**.
4. Press **Symbol Rate > 56 > ksp**.
5. Press **Filter > Select > Nyquist**.
6. Press **Return > Return > Digital Modulation Off On**.

This generates a waveform with the custom single-carrier NADC digital modulation state. The display changes to **Dig Mod Setup: NADC (Modified)**. During waveform generation, the **DIGMOD** and **I/Q** annunciators appear and the custom single-carrier digital modulation state is stored in volatile memory.

7. Set the RF output frequency to 835 MHz.
8. Set the output amplitude to 0 dBm.
9. Press **RF On/Off**.

The user-defined NADC signal is now available at the RF OUTPUT connector.

10. Press **Return > Return**.

This returns to the top-level Digital Modulation menu, where **Digital Modulation Off On** is the first softkey.

11. Press **Digital Mod Define > Store Custom Dig Mod State > Store To File.**

If there is already a file name from the Catalog of DMOD Files occupying the active entry area, press: **Edit Keys > Clear Text**

12. Enter a file name (for example, NADCQPSK) using the alpha keys and the numeric keypad.
13. Press **Enter.**

The user-defined single-carrier digital modulation state should now be stored in non-volatile memory. The RF output amplitude, frequency, and operating state settings are not stored as part of a user-defined digital modulation state file.

Customizing a Multicarrier Setup

In this procedure, you learn how to customize a predefined multicarrier digital modulation setup by creating a custom 3-carrier EDGE digital modulation state.

1. Press **Preset.**
2. Press **Mode > Custom > Arb Waveform Generator > Multicarrier Off On.**
3. Press **Multicarrier Define > Initialize Table > Carrier Setup > EDGE > Done.**
4. Highlight the **Freq Offset** value (500.000 kHz) for the carrier in row 2, and press **Edit Item > -625 > kHz.**
5. Highlight the **Power** value (0.00 dB) for the carrier in row 2, and press **Edit Item > -10 > dB.**

You have a custom 2-carrier EDGE waveform with a carrier at a frequency offset of -625 kHz and a power level of -10.00 dBm.

6. Press **Return > Digital Modulation Off On.**

This generates a waveform with the custom multicarrier EDGE state. The display changes to **Dig Mod Setup: Multicarrier (Modified)**. During waveform generation, the **DIGMOD** and **I/Q** annunciators appear and the new custom multicarrier EDGE state is stored in volatile memory.

7. Set the RF output frequency to 890.01 MHz.
8. Set the output amplitude to -10 dBm.
9. Press **RF On/Off.**

The custom multicarrier EDGE waveform is available at the RF OUTPUT connector; it does not include bursting or channel coding.

10. Press **Mode > Custom > Arb Waveform Generator**, where **Digital Modulation Off On** is the first softkey.
11. Press **Multicarrier Off On > Multicarrier Define > More (1 of 2) > Load/ Store > Store To File.**

If there is already a file name from the Catalog of MDMOD Files occupying the active entry area, press **Edit Keys > Clear Text.**

12. Enter a file name (for example, EDGEM1) using the alpha keys and the numeric keypad, and press Enter.

The user-defined multicarrier digital modulation state is now stored in non-volatile memory.

NOTE The RF output amplitude, frequency, and operating state settings (such as RF On/Off) are not stored as part of a user-defined digital modulation state file. For more information, refer to [“Using Data Storage Functions” on page 51](#).

Recalling a User-Defined Custom Digital Modulation State

In this procedure, you learn how to select (recall) a previously stored custom digital modulation state from the Memory Catalog (the Catalog of DMOD Files).

1. Press **Preset**.
2. Press **Mode > Custom > ARB Waveform Generator > Setup Select**.
3. Press **More (1 of 2) > Custom Digital Mod State**.
4. Press **Select File** to select a custom modulation state from the Catalog of DMOD Files.

The user-defined custom digital modulation state should now be recalled from non-volatile memory. Because the RF output amplitude, frequency, and operating state settings are not stored as part of a user-defined digital modulation state file, they must still be set or recalled separately. For more information, refer to [“Using Data Storage Functions” on page 51](#).

Working with Filters

This section provides information on using predefined ([page 141](#)) and user-defined ([page 142](#)) FIR filters.

NOTE The procedures in this section apply only to filters created in either the Custom Arb Waveform Generator or Custom Real Time I/Q Baseband mode; they do not work with downloaded files, such as those created in Matlab.

The **Filter** menu selections enable you to apply a filter to the generated signal, define a finite impulse response (FIR) filter, change a Root Nyquist or Nyquist filter alpha, change a Gaussian filter BbT, or restore all filter parameters to their default state. In Custom Real Time I/Q mode, you can also optimize a FIR filter for Error Vector Magnitude (EVM) or Adjacent Channel Power (ACP)

Predefined Filters (Filter > Select)

- **Root Nyquist** is a root-raised cosine pre-modulation FIR filter. Use a Root Nyquist filter when you want to place half of the filtering in the transmitter and the other half in the receiver. The ideal root-raised cosine filter frequency response has unity gain at low frequencies, the square root of raised cosine function in the middle, and total attenuation at high frequencies. The width of the middle frequencies is defined by the roll off factor or Filter Alpha ($0 < \text{Filter Alpha} < 1$).
- **Nyquist** is a raised cosine pre-modulation FIR filter. You can use a Nyquist filter to reduce the bandwidth required by a signal without losing information. The ideal raised cosine filter frequency response comprises unity gain at low frequencies, a raised cosine function in the

middle, and total attenuation at high frequencies. The width of the middle frequencies is defined by the roll off factor or Filter Alpha ($0 < \text{Filter Alpha} < 1$).

- **Gaussian** is a Gaussian pre-modulation FIR filter.
- **User FIR** enables you to select from a Catalog of FIR filters; use this selection if the other predefined FIR filters do not meet your needs. For more information, see **Define User FIR**, below.
- **Rectangle** is a rectangular pre-modulation FIR filter.
- **APCO 25 C4FM** is an APCO 25-specified C4FM filter; this is a Nyquist filter with an alpha of 0.200 that is combined with a shaping filter.

Filter Parameters

- **Define User FIR** is available for when the predefined FIR filters do not meet your needs. You can define FIR coefficients and set the oversample ratio (number of filter coefficients per symbol) to be applied to a custom FIR filter.
- **Filter Alpha** enables you to adjust the filter alpha for a Nyquist or root Nyquist filter. If a Gaussian filter is used, you will see Filter BbT; this softkey is grayed out when any other filter is selected.
- (*Custom Realtime I/Q Baseband Only*) **Optimize FIR for EVM ACP** enables you to optimize a Nyquist or root Nyquist filter for minimized error vector magnitude (EVM) or for minimized adjacent channel power (ACP); the softkey is grayed out when any other filter is selected.
- **Restore Default Filters** replaces the current FIR filter with the default FIR filter for the selected format.

Using a Predefined FIR Filter

Selecting a Predefined FIR Filter

1. Preset the instrument: Press **Preset**.
2. Press **Mode > Custom > ARB Waveform Generator > Digital Mod Define > Filter > Select**
or
Mode > Custom > Real Time I/Q Baseband > Filter > Select >
3. Select the desired filter. If the filter you want is not in the first list, press **More (1 of 2)**.

Adjusting the Filter Alpha of a Predefined Root Nyquist or Nyquist Filter

1. Preset the instrument: Press **Preset**.
2. Press **Mode > Custom > ARB Waveform Generator > Digital Mod Define > Filter > Filter Alpha**
or
Mode > Custom > Real Time I/Q Baseband > Filter > Filter Alpha
3. Enter a new Filter Alpha value and press **Enter**.

Adjusting the Bandwidth-Bit-Time (BbT) Product of a Predefined Gaussian Filter

1. Press **Mode > Custom > ARB Waveform Generator > Digital Mod Define > Filter > Select > Gaussian**
or
Mode > Custom > Real Time I/Q Baseband > Filter > Select > Gaussian
2. Press **Filter BbT**.
3. Enter a new Bandwidth-Bit-Time (BbT) product filter parameter and press **Enter**.

Optimizing a Nyquist or Root Nyquist FIR Filter for EVM or ACP (Custom Realtime I/Q Baseband only)

1. Preset the instrument: Press Preset.
2. Press **Mode > Custom > Real Time I/Q Baseband > Filter > Optimize FIR For EVM or ACP.**
The FIR filter is now optimized for minimum error vector magnitude (EVM) or for minimum adjacent channel power (ACP). This feature applies only to Nyquist and root Nyquist filters; the softkey is grayed out when any other filter is selected.

Restoring Default FIR Filter Parameters

1. Preset the instrument: Press Preset.
2. Press **Mode > Custom > ARB Waveform Generator > Digital Mod Define > Filter > Restore Default Filter.**
This replaces the current FIR filter with the default filter for the selected modulation format.

Using a User-Defined FIR Filter

FIR filters can be created and modified by defining the FIR coefficients or by defining the oversample ratio (number of filter coefficients per symbol) to be applied to your own custom FIR filter.

To Modify Predefined FIR Coefficients for a Gaussian Filter Using the FIR Values Editor

You can define from 1 to 32 FIR coefficients, where the maximum combination of symbols and oversample ratio is 1024 coefficients. While the FIR Values editor allows a maximum filter length of 1024 coefficients, the PSG hardware is limited to 64 symbols for real-time and 512 symbols for arbitrary waveform generation (the number of symbols equals the number of coefficients divided by the oversample ratio).

If you enter more than 64 symbols for real-time or 512 symbols for arbitrary waveform generation, the PSG cannot use the filter; it will decimate the filter (throw away coefficients) until the required condition is met and then use the filter, but fine resolution may be lost from the impulse response.

FIR filters stored in signal generator memory can easily be modified using the FIR Values editor. In this example, you will load the FIR Values editor with coefficient values from a default FIR filter (or, if one has been defined, a user-defined FIR file that has been stored in the Memory Catalog), modify the coefficient values, and store the new file to the Memory Catalog.

1. Press Preset.
2. Press **Mode > Custom > Arb Waveform Generator > Digital Mod Define > Filter**
or **Mode > Custom > Real Time I/Q Baseband > Filter**
3. Press **Define User FIR > More (1 of 2) > Load Default FIR > Gaussian.**
4. Press **Filter BbT > 0.300 > Enter.**
5. Press **Filter Symbols > 8 > Enter.**
6. Press Generate.

NOTE The actual oversample ratio during modulation is automatically selected by the instrument. A value between 4 and 16 is chosen dependent on the symbol rate, the number of bits per symbol of the modulation type, and the number of symbols.

- Press **Display Impulse Response**. A graph displays the impulse response of the current FIR coefficients.

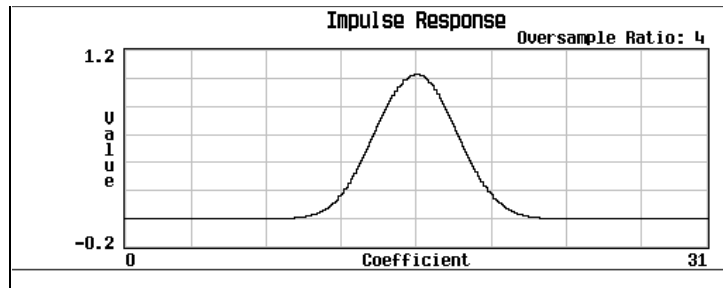

- Press **Return**.
- Highlight coefficient 15.
- Press **0 > Enter**.
- Press **Display Impulse Response**.

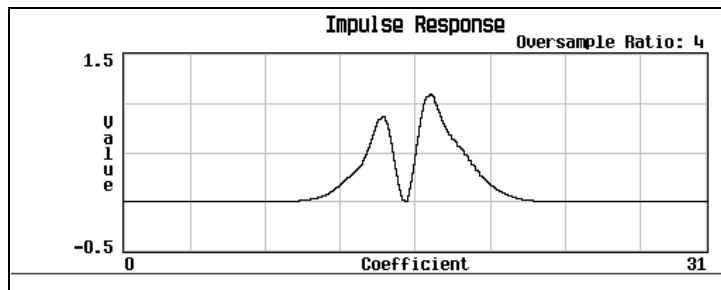

The graphic display can provide a useful troubleshooting tool (in this case, it indicates that a coefficient value is set incorrectly, resulting in an improper Gaussian response).

- Press **Return**.
- Highlight coefficient 15.
- Press **1 > Enter**.
- Press **Load/Store > Store To File**.
- Name the file **NEWFIR2**, and press **Enter**.

The contents of the current FIR Values editor are stored to a file in the Memory Catalog and the Catalog of FIR Files is updated to show the new file.

To Create a User-Defined FIR Filter with the FIR Values Editor

In this procedure, you use the FIR Values editor to create and store an 8-symbol, windowed, sinc function filter with an oversample ratio of 4. The Oversample Ratio (OSR) is the number of filter coefficients per symbol.

You can define from 1 to 32 FIR coefficients, where the maximum combination of symbols and oversample ratio is 1024 coefficients.

The FIR Values editor allows a maximum filter length of 1024 coefficients, but the PSG hardware is limited to 512 symbols for arbitrary waveform generation, and 64 symbols for real-time waveform generation. The number of symbols equals the number of coefficients divided by the oversample ratio. If you enter more than the maximum number of symbols, the PSG cannot use the filter; it decimates the filter (throws away coefficients) until the required condition is met and then uses the filter, but fine resolution may be lost from the impulse response.

1. Press **Preset**.
2. Press **Mode > Custom > Arb Waveform Generator > Digital Mod Define > Filter**
or
Mode > Custom > Real Time I/Q Baseband > Filter
3. Press **Define User FIR > More (1 of 2)**.
4. Press **Delete All Rows > Confirm Delete Of All Rows > More (2 of 2)**.

This brings up the FIR Values editor and clears the table of existing values.

FREQUENCY 44.000 000 000 000 GHz		AMPLITUDE -130.00 dBm	Edit Item
		RF OFF	MOD ON
		Insert Row	
		Delete Row	
FIR Values		Oversample Ratio: 4	
Coeff.	Value	Goto Row	
0	<input type="text"/>	Mirror Table	
		Oversample Ratio 4	
		More (1 of 2)	

5. Press **Edit Item**. The Value field for coefficient 0 should be highlighted.
6. Use the numeric keypad to type the first value (-0.000076) from the following table and press **Enter**. As you press the numeric keys, the numbers are displayed in the active entry area. (If you make a mistake, you can correct it using the backspace key.) Continue entering the coefficient values from the table until all 16 values have been entered.

Coefficient	Value
0	-0.000076
1	-0.001747
2	-0.005144
3	-0.004424
4	0.007745
5	0.029610

Coefficient	Value
6	0.043940
7	0.025852
8	-0.035667
9	-0.116753
10	-0.157348
11	-0.088484

Coefficient	Value
12	0.123414
13	0.442748
14	0.767329
15	0.972149

7. Press **Mirror Table**.

In a windowed sinc function filter, the second half of the coefficients are identical to the first half, but in reverse order. The signal generator provides a mirror table function that automatically duplicates the existing coefficient values in the reverse order; coefficients 16 through 31 are automatically generated and the first of these coefficients (number 16) highlights, as shown in the following figure.

The screenshot shows the 'FIR Values (UNSTORED)' editor. At the top, it displays 'FREQUENCY 44.000 000 000 000 GHz' and 'AMPLITUDE -130.00 dBm'. There are 'RF OFF' and 'MOD ON' buttons. Below the title bar, the 'Oversample Ratio' is set to 4. The main table lists coefficients from 10 to 19. Coefficient 16 is highlighted. To the right of the table are several control buttons: 'Edit Item', 'Insert Row', 'Delete Row', 'Goto Row', 'Mirror Table', and 'Oversample Ratio 4'. At the bottom right, it says 'More (1 of 2)'.

Coeff.	Value
10	-0.157348
11	-0.088484
12	0.123414
13	0.442748
14	0.767329
15	0.972149
16	0.972149
17	0.767329
18	0.442748
19	0.123414

8. For this example, the desired OSR is 4, which is the default, so no action is necessary.

The Oversample Ratio (OSR) is the number of filter coefficients per symbol. Acceptable values range from 1 through 32; the maximum combination of symbols and oversampling ratio allowed by the FIR Values editor is 1024. Remember, however, that the instrument hardware is limited to 64 symbols for real-time waveform generation, and 512 symbols for arbitrary waveform generation. The number of symbols equals the number of coefficients divided by the oversample ratio.

9. Press **More (1 of 2)** > **Display FFT** (fast Fourier transform).

A graph displays the fast Fourier transform of the current set of FIR coefficients. The signal generator has the capability of graphically displaying the filter in both time and frequency dimensions.

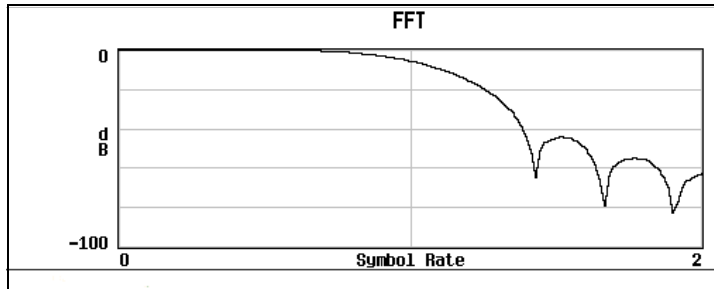

10. Press **Return** > **Display Impulse Response**.

A graph shows the impulse response of the current set of FIR coefficients.

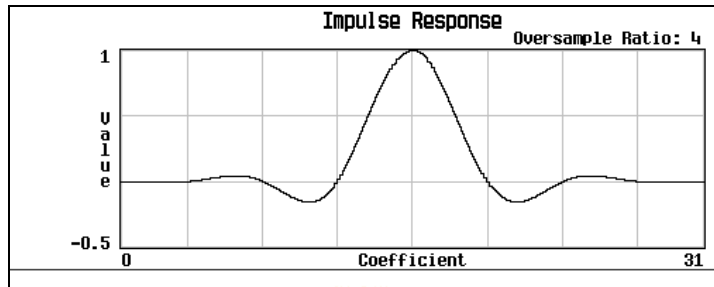

11. Press **Return** > **Load/Store** > **Store To File**.

The Catalog of FIR Files appears along with the amount of memory available.

12. If there is already a file name occupying the active entry area, press: **Edit Keys** > **Clear Text**
13. Using the alphabetic menu and the numeric keypad, enter **NEWFIR1** as the file name.
14. Press **Enter**.

The **NEWFIR1** file is the first file name listed. (If you have previously stored other FIR files, additional file names are listed below **NEWFIR1**.) The file type is **FIR** and the size of the file is 260 bytes. The amount of memory used is also displayed. The number of files that can be saved depends on the size of the files and the amount of memory used.

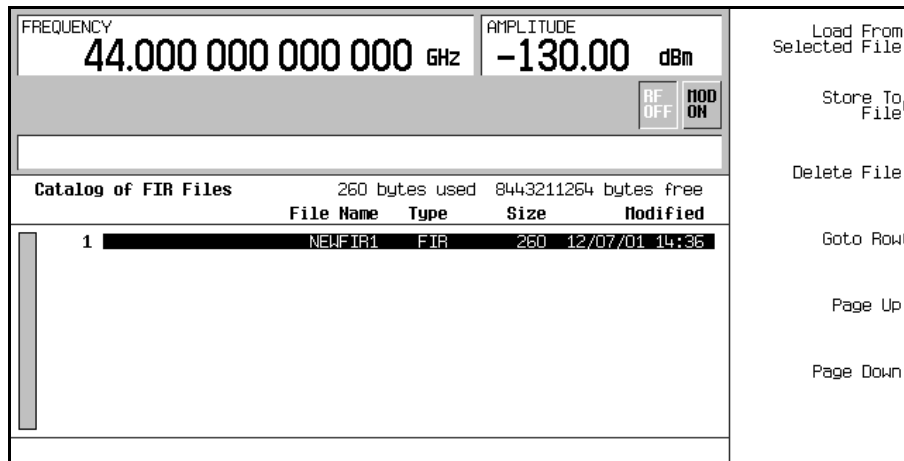

Working with Symbol Rates

The Symbol Rate menu enables you to set the rate at which I/Q symbols are fed to the I/Q modulator. The default transmission symbol rate can also be restored in this menu.

- Symbol Rate (displayed as Sym Rate) is the number of symbols per second that are transmitted using the modulation (displayed as Mod Type) along with the filter and filter alpha (displayed as Filter). Symbol rate directly influences the occupied signal bandwidth.

Symbol Rate is the Bit Rate divided by the number of bits that can be transmitted with each symbol; this is also known as the Baud Rate.

- Bit Rate is the frequency of the system bit stream. The internal baseband generator (Option 602) automatically streams the selected Data Pattern at the appropriate rate to accommodate the symbol rate setting (Bit Rate = Symbols/s x Number of Bits/Symbol).
- Occupied Signal Bandwidth = Symbol Rate x (1 + Filter Alpha); therefore, the occupied signal bandwidth is dependent on the filter alpha of the Nyquist or Root Nyquist filter being used. (To change the filter alpha, refer to the procedure, [“Adjusting the Filter Alpha of a Predefined Root Nyquist or Nyquist Filter”](#) on page 141.)

To Set a Symbol Rate

1. Press Preset.
2. Press Mode > Custom > ARB Waveform Generator > Digital Mod Define > Symbol Rate
or
Mode > Custom > Real Time I/Q Baseband > Symbol Rate
3. Enter a new symbol rate and press Msps, ksps, or sps.

To Restore the Default Symbol Rate (Custom Real Time I/Q Only)

- Press **Mode** > **Custom** > **Real Time I/Q Baseband** > **Symbol Rate** > **Restore Default Symbol Rate**.

This replaces the current symbol rate with the default symbol rate for the selected modulation format.

Modulation Type		Bits Per Symbol	Bit Rate = Symbols/s x Number of Bits/Symbol	Internal Symbol Rate (Minimum Maximum)	Custom Real Time Only External Symbol Rate (Minimum Maximum)
PSK Phase Shift Keying	QPSK and OQPSK (quadrature phase shift keying and offset quadrature phase shift keying) Includes: QPSK, IS95 QPSK, Gray Coded QPSK, OQPSK, IS95 OQPSK	2	90 bps – 100 Mbps	45 sps – 50 Msps	45 sps – 25 Msps
	BPSK (binary phase shift keying)	1	45 bps – 50 Mbps	45 sps – 50 Msps	45 sps – 50 Msps
	$\pi/4$ DQPSK	2	90 bps – 100 Mbps	45 sps – 50 Msps	45 sps – 25 Msps
	8PSK (eight phase state shift keying)	3	135 bps – 150 Mbps	45 sps – 50 Msps	45 sps – 16.67 Msps
	16PSK (sixteen phase state shift keying)	4	180 sps – 200 Mbps	45 sps – 50 Msps	45 sps – 12.5 Msps
	D8PSK (eight phase state shift keying)	3	135 bps – 150 Mbps	45 sps – 50 Msps	45 sps – 16.67 Msps
MSK Minimum Shift Keying	MSK (GSM - Global System for Mobile Communications)	1	45 bps – 50 Mbps	45 sps – 50 Msps	45 sps – 50 Msps
FSK Frequency Shift Keying	2-Lvl FSK	1	45 bps – 50 Mbps	45 sps – 50 Msps	45 sps – 50 Msps
	4-Lvl FSK	2	90 bps – 100 Mbps	45 sps – 50 Msps	45 sps – 25 Msps
	8-Lvl FSK	3	135 bps – 150 Mbps	45 sps – 50 Msps	45 sps – 16.67 Msps
	16-Lvl FSK	4	180 bps – 200 Mbps	45 sps – 50 Msps	45 sps – 12.5 Msps
	C4FM	2	90 bps – 100 Mbps	45 sps – 50 Msps	45 sps – 25 Msps

Modulation Type		Bits Per Symbol	Bit Rate = Symbols/s x Number of Bits/Symbol	Internal Symbol Rate (Minimum Maximum)	Custom Real Time Only External Symbol Rate (Minimum Maximum)
QAM	4QAM	2	90 bps – 100 Mbps	45 sps – 50 Msps	45 sps – 25 Msps
Quadrature Amplitude Modulation	16QAM	4	180 bps – 200 Mbps	45 sps – 50 Msps	45 sps – 12.5 Msps
	32QAM	5	225 bps – 250 Mbps	45 sps – 50 Msps	45 sps – 10 Msps
	64QAM	6	270 bps – 300 Mbps	45 sps – 50 Msps	45 sps – 8.33 Msps
	128QAM There is no preset value for this modulation, it must be user defined.	7	315 bps – 350 Mbps	45 sps – 50 Msps	45 sps – 7.14 Msps
	256QAM	8	360 bps – 400 Mbps	45 sps – 50 Msps	45 sps – 6.25 Msps

Working with Modulation Types

The Modulation Type menu enables you to specify the type of modulation applied to the carrier signal when the **Mod On Off** hardkey is on.

When the **Custom Off On** softkey is on:

- For Custom Arb, the BBG (baseband generator) creates a sampled version of the I/Q waveform based on a random data pattern and the modulation type that has been selected.
- For Custom Real Time I/Q, the real-time custom I/Q symbol builder creates I/Q symbols based on the data pattern and modulation type that has been selected (see [“Working with Data Patterns” on page 160](#) for information on selecting a data pattern).

In Custom Real Time I/Q, you can also:

- Create user-defined modulation type (see [page 150](#)) that can be used immediately or saved to the Memory Catalog.
- Restore all modulation parameters to their default state.

To Select a Predefined Modulation Type

1. Press **Preset**.
2. Press **Mode > Custom > ARB Waveform Generator > Digital Mod Define > Modulation Type > Select**
or
Mode > Custom > Real Time I/Q Baseband > Modulation Type > Select
3. Select one of the available modulation types.

NOTE If you select **QPSK** and **OQPSK**, you must make a specific selection from the menu that displays.

To Use a User-Defined Modulation Type (Real Time I/Q Only)

Creating a 128QAM I/Q Modulation Type User File with the I/Q Values Editor

In I/Q modulation schemes, symbols appear in default positions in the I/Q plane. Using the I/Q Values editor, you can define your own symbol map by changing the position of one or more symbols. Use the following procedure to create and store a 128-symbol QAM modulation.

NOTE Although this procedure provides a quick way to implement a 128QAM modulation format, it does not take full advantage of the I/Q modulator's dynamic range. This is because you begin with a 256QAM constellation, and delete unwanted points. The remaining points that make up the 128QAM constellation are closer together than if you had mapped each point specifically. Additionally, this approach does not enable you to define the bit pattern associated with each symbol point, as you could if the 128QAM constellation had been defined one point at a time.

1. Press **Preset**.
2. Press **Mode > Custom > Real Time I/Q Baseband > Modulation Type > Define User I/Q > More (1 of 2) > Load Default I/Q Map > QAM > 256QAM**.

This loads a default 256QAM I/Q modulation into the I/Q Values editor.

3. Press **More (2 of 2) > Display I/Q Map**.

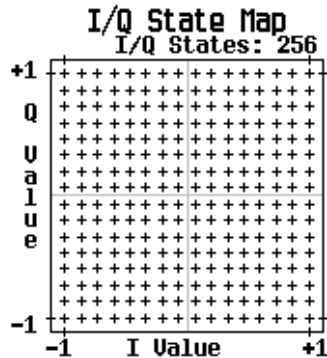

In the next steps, you will delete specific portions of this I/Q constellation and change it into a 128QAM with 128 I/Q states.

4. Press **Return > Goto Row > 0011 0000 > Enter**; this is row 48.

- Press the **Delete Row** softkey 16 times.

Repeat this pattern of steps using the following table:

Goto Row...	Press the Delete Row softkey...
0110 0000 (96)	16 times
1001 0000 (144)	16 times
1100 0000 (192)	16 times
0001 0000 (16)	4 times
0001 0100 (20)	4 times
0001 1000 (24)	8 times
0011 0000 (48)	4 times
0011 0100 (52)	4 times
0011 1000 (56)	4 times
0101 1000 (88)	8 times
0111 0000 (112)	4 times
0111 0100 (116)	4 times
0111 1000 (120)	8 times

- Press **Display I/Q Map** to view the new constellation that has been created. The I/Q State Map in this example has 128 symbols.
- Press **Return**. When the contents of an I/Q Values table have not been stored, I/Q Values (UNSTORED) appears on the display.
- Press **More (1 of 2) > Load/Store > Store To File**.

If there is already a file name from the Catalog of IQ Files occupying the active entry area, press the following keys:

Editing Keys > Clear Text

- Enter a file name (for example, 128QAM) using the alpha keys and the numeric keypad.
- Press **Enter**.

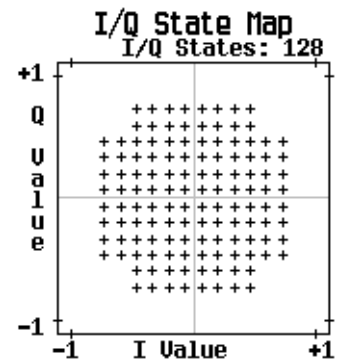

The user-defined I/Q State Map should now be stored in the Catalog of IQ Files.

Creating a QPSK I/Q Modulation Type User File with the I/Q Values Editor

In I/Q modulation schemes, symbols appear in default positions in the I/Q plane. Using the I/Q Values editor, you can define your own symbol map by changing the position of one or more symbols. Use the following procedure to create and store a 4-symbol unbalanced QPSK modulation.

- Press **Preset**.

2. Press **Mode > Custom > Real Time I/Q Baseband > Modulation Type > Define User I/Q > More (1 of 2) > Delete All Rows > Confirm Delete All Rows**.

This loads a default 4QAM I/Q modulation and clears the I/Q Values editor.

3. Enter the I and Q values listed in the following table:

Symbol	Data	I Value	Q Value
0	0000	0.500000	1.000000
1	0001	-0.500000	1.000000
2	0010	0.500000	-1.000000
3	0011	-0.500000	-1.000000

- a. Press **0.5 > Enter**.
- b. Press **1 > Enter**.
- c. Enter the remaining I and Q values.

As the I value updates, the highlight moves to the first Q entry (and provides a default value of 0) and an empty row of data appears below the first row. As the Q value updates, the highlight moves to the next I value. As you press the numeric keys, the numbers display in the active entry area. If you make a mistake, use the backspace key and retype.

Also note that 0.000000 appears as the first entry in the list of Distinct Values, and that 0.500000 and 1.000000 are listed as the distinct values.

4. Press **More (2 of 2) > Display I/Q Map**.

An I/Q State Map is displayed from the current values in the I/Q Values table.

The I/Q State Map in this example has four symbols. The I/Q State Map uses the following *four* unique values: 0.5, 1.0, -0.5, and -1.0 to create the four symbols. It is not the number of values that defines how many symbols a map has, but how those values are combined.

5. Press **Return**.

When the contents of an I/Q Values table have not been stored, I/Q Values (UNSTORED) appears on the display.

6. Press **More (1 of 2) > Load/Store > Store To File**.

If there is already a file name from the Catalog of IQ Files occupying the active entry area, press the following keys: **Editing Keys > Clear Text**

7. Enter a file name (for example, NEW4QAM) using the alpha keys and the numeric keypad.
8. Press **Enter**. The user-defined I/Q State Map should now be stored in the Catalog of IQ Files and can be recalled even after the signal generator has been turned off.

Modifying a Predefined I/Q Modulation Type (I/Q Symbols) & Simulating Magnitude Errors & Phase Errors

Use the following procedure to manipulate symbol locations which simulate magnitude and phase errors. In this example, you edit a 4QAM constellation to move one symbol closer to the origin.

1. Press **Preset**.
2. Press **Mode > Custom > Real Time I/Q Baseband > Modulation Type > Define User I/Q > More (1 of 2) > Load Default I/Q Map > QAM > 4QAM**.

This loads a default 4QAM I/Q modulation into the I/Q Values editor.

3. Press **More (2 of 2)**.
4. In the I/Q Values editor, navigate to Data 00000000 and press **Edit Item**.
5. Press **.235702 > Enter**, then **.235702 > Enter**.

When you press **Enter** the first time, the I value updates and the highlight moves to the first Q entry. The second time, the Q value updates and the highlight moves to the following I entry.

6. Press **Display I/Q Map**. Note that one symbol has moved, as shown.

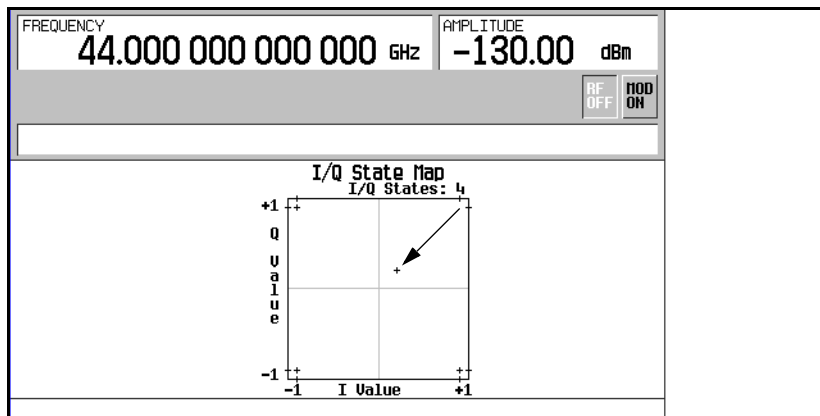

Creating an FSK Modulation Type User File with the Frequency Values Editor

Use this procedure to set the frequency deviation for data 00, 01, 10, and 11 to configure a user-defined FSK modulation.

1. Press **Preset**.
2. Press **Mode > Custom > Real Time I/Q Baseband > Modulation Type > Define User FSK > More (1 of 2) > Delete All Rows > Confirm Delete All Rows**.

This accesses the Frequency Values editor and clears the previous values.

3. Press **600 > Hz**.
4. Press **1.8 > kHz**.
5. Press **-600 > Hz**.

6. Press **-1.8 > kHz**.

Each time you enter a value, the Data column increments to the next binary number, up to a total of 16 data values (from 0000 to 1111). An unstored file of frequency deviation values is created for the custom 4-level FSK file.

7. Press **Load/Store > Store To File**.

If there is already a file name from the Catalog of FSK Files occupying the active entry area, press the following keys:

Edit Keys > Clear Text

8. Enter a file name (for example, **NEWFSK**) using the alpha keys and the numeric keypad.
9. Press **Enter**.

The user-defined FSK modulation should now be stored in the Catalog of FSK Files.

Modifying a Predefined FSK Modulation Type User File with the Frequency Values Editor

Using the Frequency Values editor, you can define, modify, and store user-defined frequency shift keying modulation. The Frequency Values editor is available for custom Real-Time I/Q Baseband mode, but is not available for waveforms generated in custom Arb Waveform Generator mode. Use this example to learn how to add errors to a default FSK modulation.

1. Press **Preset**.
2. Press **Mode > Custom > Real Time I/Q Baseband > Modulation Type > Define User FSK > More (1 of 2) > Load Default FSK**.
3. Press **Freq Dev > 1.8 > kHz**.
4. Press **4-Lvl FSK**.

This sets the frequency deviation and opens the Frequency Values editor with the 4-level FSK default values displayed. The frequency value for data 0000 is highlighted.

5. Press **-1.81 > kHz**.
6. Press **-590 > Hz**.
7. Press **1.805 > kHz**.
8. Press **610 > Hz**.

As you modify the frequency deviation values, the cursor moves to the next data row. An unstored file of frequency deviation values is created for your custom 4-level FSK file.

9. Press **Load/Store > Store To File**.

If there is already a file name from the Catalog of FSK Files occupying the active entry area, press the following keys:

Edit Keys > Clear Text

10. Enter a file name (for example, **NEWFSK**) using the alpha keys and the numeric keypad.
11. Press **Enter**.

The user-defined FSK modulation should now be stored in the Catalog of FSK Files.

Wide Band IQ (Option 015)

The signal generator with Option 015 can use an external I/Q modulation source such as a two channel arbitrary waveform generator to generate up to 2 GHz modulation bandwidth at RF. To enable the wideband I/Q inputs:

1. Press the front panel I/Q hardkey.
2. Press I/Q Off.
3. Press I/Q Path Wide (Ext Rear Inputs).
4. Press I/Q On.

Connect the external I/Q modulation source to the signal generator's Wideband I and Wideband Q rear-panel inputs. The voltage level at the inputs is ± 1 Vdc. Wideband IQ (Option 015) is available for RF above 3.2 GHz. Refer to the Option 015 data sheet for more information.

It is possible to use the signal generator's internal arbitrary waveform generator (ARB) as a baseband source while using the wideband inputs at RF. The internal ARB I and Q signals are available at the rear panel of the PSG. Use the following steps to setup the internal ARB as a baseband source and enable the wideband inputs.

1. Set up the internal baseband generator with the desired signal.
2. Press the Mux hardkey.
3. Press I/Q Out.
4. Press BBG1
5. Press the front panel I/Q softkey.
6. Press I/Q Off.
7. Press I/Q Path Wide (Ext Rear Inputs).
8. Press I/Q On.

Configuring Hardware

- [To Set the ARB Reference](#) see [page 157](#)

To Set a Delayed, Positive Polarity, External Single Trigger

Using this procedure, you learn how to utilize an external function generator to apply a delayed single-trigger to a custom multicarrier waveform.

1. Connect an Agilent 33120A function generator or equivalent to the signal generator PATT TRIGGER IN port, as shown in [Figure 6-1](#).

Figure 6-1

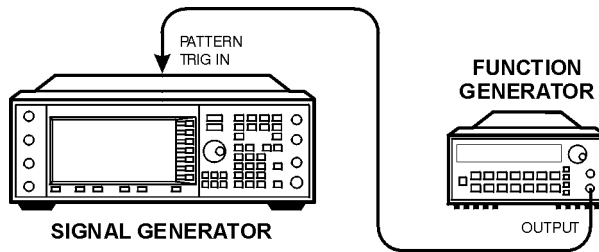

pk719b

2. On the signal generator, press Preset.
3. Press Mode > Custom > Arb Waveform Generator.
4. Press Multicarrier Off On until On is highlighted.
5. Press Trigger > Single.
6. Press Trigger > Trigger Setup > Trigger Source > Ext.
7. Press Ext Polarity Neg Pos until Pos is highlighted.
8. Press Ext Delay Off On until On is highlighted.
9. Press Ext Delay Time > 100 > msec.

The Custom Arb Waveform Generator has been configured to play a single multicarrier waveform 100 milliseconds after it detects a change in TTL state from low to high at the PATT TRIG IN rear panel connector.

10. Set the function generator waveform to a 0.1 Hz square wave at an output level of 0 to 5V.
11. On the signal generator, press Mode > Custom > Arb Waveform Generator > Digital Modulation Off On until On is highlighted.

This generates a waveform with the custom multicarrier state and the display changes to Dig Mod Setup: Multicarrier.

During waveform generation, the DIGMOD and I/Q annunciators activate and the new custom multicarrier state is stored in volatile ARB memory. The waveform should be modulating the RF carrier.

12. Press RF On/Off.

The externally single-triggered custom multicarrier waveform should be available at the signal generator's RF OUTPUT connector 100 ms after receiving a change in TTL state from low to high at the PATT TRIG IN.

To Set the ARB Reference

Setting for an External or Internal Reference

1. Press **Custom > Arb Waveform Generator > More (1 of 2)**.
2. Press **ARB Reference Ext Int** to select either external or internal as the waveform sample clock reference.
 - If you select **Ext**, you must enter the reference frequency (250 kHz to 100 MHz) and apply the reference signal to the rear-panel **BASEBAND GEN REF IN**.
 - If you select **Int**, the internal clock is used for the arbitrary waveform (ARB) frequency reference.

Setting the External Frequency

The external Arb reference frequency is only used when the **ARB Reference Ext Int** softkey has been set to **Ext** (external).

1. Press **Custom > Arb Waveform Generator > More (1 of 2)**.
2. Press **Reference Freq**, enter a desired frequency (250 kHz to 100 MHz), and press **MHz**, **kHz**, or **Hz**.

7 Custom Real Time I/Q Baseband

In the following sections, this chapter describes the custom real-time I/Q baseband mode, which is available only in E8267D PSG vector signal generators with Option 601 or 602:

- [“Overview” on page 159](#)
- [“Working with Predefined Setups \(Modes\)” on page 159](#)
- [“Working with Data Patterns” on page 160](#)
- [“Working with Burst Shapes” on page 165](#)
- [“Configuring Hardware” on page 169](#)
- [“Working with Phase Polarity” on page 171](#)
- [“Working with Differential Data Encoding” on page 171](#)

See also: [Chapter 3, “Basic Digital Operation,” on page 67](#)

Overview

Custom Real Time I/Q Baseband mode can produce a single carrier, but it can be modulated with real time data that allows real time control over all of the parameters that affect the signal. The single carrier signal that is produced can be modified by applying various data patterns, filters, symbol rates, modulation types, and burst shapes.

To begin using the Custom Real Time I/Q Baseband mode, start by selecting from a set of predefined modes (setups) or specify a setup by selecting a Data Pattern, Filter, Symbol Rate, Modulation Type, Burst Shape, Configure Hardware, Phase Polarity, and whether Diff Data Encode is off or on.

Working with Predefined Setups (Modes)

When you select a predefined mode, default values for components of the setup (including the filter, symbol rate, and modulation type) are automatically specified.

Selecting a Predefined Real Time Modulation Setup

The following steps select a predefined mode where filtering, symbol rate, and modulation type are defined by the APCO 25 w/C4FM digital modulation standard, and return to the top-level custom modulation menu.

1. Press **Preset**.
2. Press **Mode > Custom > Real Time I/Q Baseband**.
3. Press **More (1 of 3) > More (2 of 3) > Predefined Mode > APCO 25 w/C4FM**.
4. Press **More (3 of 3)**.

Deselecting a Predefined Real Time Modulation Setup

To deselect any predefined mode that has been previously selected, and return to the top-level custom modulation menu:

1. Press **Preset**.
2. Press **Mode > Custom > Real Time I/Q Baseband**.
3. Press **More (1 of 3) > More (2 of 3) > Predefined Mode > None**.
4. Press **More (3 of 3)**.

Working with Data Patterns

This section provides information on the following:

- [“Using a Predefined Data Pattern” on page 161](#)
- [“Using a User-Defined Data Pattern” on page 161](#)
- [“Using an Externally Supplied Data Pattern” on page 165](#)

The Data menu enables you to select from predefined and user defined data patterns. Data Patterns are used for transmitting continuous streams of unframed data. When the Custom Off On softkey is on, the real-time custom I/Q symbol builder creates I/Q symbols based on the data pattern and modulation type that has been selected. Refer to [“Working with Modulation Types” on page 149](#) for information on selecting a modulation type.

The following data patterns are available:

- PN sequence allows you to access a menu (PN9, PN11, PN15, PN20, PN23) for internal data generation of pseudorandom sequences (pseudorandom noise sequences); a pseudorandom noise sequence is a periodic binary sequence approximating, in some sense, a Bernoulli “coin tossing” process with equiprobable outcomes.
- FIX4 0000 allows you to define a 4-bit repeating sequence data pattern and make it the active function. The selected 4-bit pattern will be repeated as necessary to provide a continuous stream of data.
- Other Patterns allows you to access a menu of choices (4 1’s & 4 0’s, 8 1’s & 8 0’s, 16 1’s & 16 0’s, 32 1’s & 32 0’s, or 64 1’s & 64 0’s) from which you can select a data pattern. Each pattern contains an equal number of ones and zeroes. The selected pattern will be repeated as necessary to provide a continuous stream of data.
- User File allows you to access a menu of choices from which you can create a file and store it to the Catalog of Bit Files, select from a Catalog of Bit Files and use it, or select from a Catalog of Bit Files, edit the file, and resave the file.
- Ext allows data patterns to be fed into the I/Q symbol builder, through the DATA port, in real-time.

Using a Predefined Data Pattern

Selecting a Predefined PN Sequence Data Pattern

1. Press **Preset**.
2. Press **Mode > Custom > Real Time I/Q Baseband > Data > PN Sequence**.
3. Press one of the following: **PN9, PN11, PN15, PN20, PN23**.

Selecting a Predefined Fixed 4-bit Data Pattern

1. Press **Preset**.
2. Press **Mode > Custom > Real Time I/Q Baseband > Data > FIX4**.
3. Press **1010 > Enter > Return**.

Selecting a Predefined Data Pattern Containing an Equal Number of 1s & 0s

1. Press **Preset**.
2. Press **Mode > Custom > Real Time I/Q Baseband > Data > Other Patterns**.
3. Press one of the following:
 4 1's & 4 0's, 8 1's & 8 0's, 16 1's & 16 0's, 32 1's & 32 0's, or 64 1's & 64 0's.

Using a User-Defined Data Pattern

User Files (user-defined data pattern files) can be created and modified using the signal generator's **Bit File Editor** or they can be created on a remote computer and moved to the signal generator for direct use; these remotely created data pattern files can also be modified with the **Bit File Editor**. For information on creating user-defined data files on a remote computer, see the *ES257D/67D PSG Signal Generators Programming Guide*.

These procedures demonstrate how to use the **Bit File Editor** to create, edit, and store user-defined data pattern files for use within the custom real-time I/Q baseband generator modulation. For this example, a user file is defined within a custom digital communication.

Creating a Data Pattern User File with the Bit File Editor

This procedure uses the **Bit File Editor** to create a **Data Pattern User File** and stores the resulting file in the **Memory Catalog** (described on [page 51](#)).

1. Press **Preset**.
2. Press **Mode > Custom > Real Time I/Q Baseband > Data > User File > Create File**.

This opens the **Bit File Editor**, which contains three columns, as shown in the following figure.

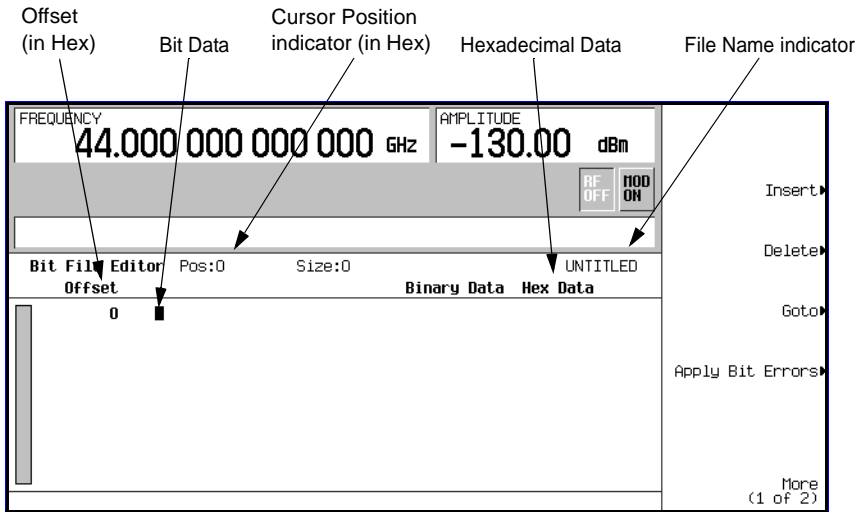

NOTE When you create a new file, the default name is UNTITLED, or UNTITLED1, and so forth. This prevents overwriting previous files.

3. Using the numeric keypad (*not* the softkeys), enter the 32 bit values shown.

Bit data is entered into the Bit File Editor in 1-bit format. The current hexadecimal value of the binary data is shown in the Hex Data column and the cursor position (in hexadecimal) is shown in the Position indicator.

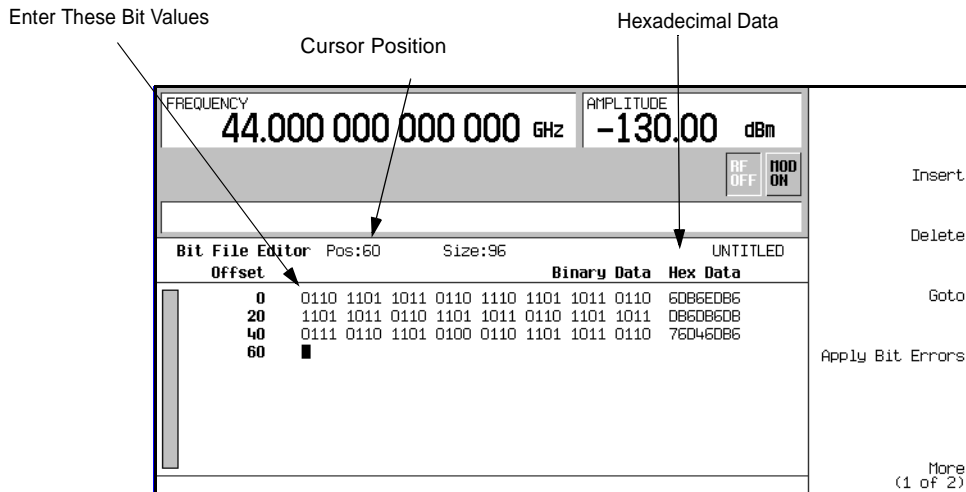

4. Press **More (1 of 2)** > **Rename** > **Editing Keys** > **Clear Text**.
5. Enter a file name (for example, USER1) using the alpha keys and the numeric keypad.
6. Press **Enter**.

The user file should be renamed and stored to the Memory Catalog with the name USER1.

Selecting a Data Pattern User File from the Catalog of Bit Files

In this procedure, you learn how to select a data pattern user file from the Catalog of Bit Files. If you have not created and stored a user-defined data file, complete the steps in the previous section, [“Creating a Data Pattern User File with the Bit File Editor” on page 161](#).

1. Press **Preset**.
2. Press **Mode** > **Custom** > **Real Time I/Q Baseband** > **Data** > **User File**.
3. Highlight the file to be selected (for example, USER1).
4. Press **Edit File**.

The Bit File Editor should open the selected file (for example, USER1).

Modifying an Existing Data Pattern User File

In this example, you learn how to modify an existing data pattern user file by navigating to a particular bit position and changing its value. Next, you will learn how to invert the bit values of an existing data pattern user file.

If you have not already created, stored, and recalled a data pattern user file, complete the steps in the previous sections, [“Creating a Data Pattern User File with the Bit File Editor” on page 161](#) and [“Selecting a Data Pattern User File from the Catalog of Bit Files” on page 163](#).

Navigating the Bit Values of an Existing Data Pattern User File

1. Press Goto > 4 > C > Enter.

This moves the cursor to bit position 4C, of the table, as shown in the following figure.

Cursor moves to new position

Position indicator changes

Offset	Binary Data	Hex Data
0	0110 1101 1011 0110 1110 1101 1011 0110	60B6E0B6
20	1101 1011 0110 1101 1011 0110 1101 1011	0B60B60B
40	0111 0110 1101 1100 0110 1101 1011 0110	76D460B6
60		

Inverting the Bit Values of an Existing Data Pattern User File

1. On the keypad, press 1011.

This inverts the bit values that are positioned 4C through 4F. Notice that hex data in this row has now changed to 76DB6DB6, as shown in the following figure.

Bits 4C through 4F inverted

Hex Data changed

Offset	Binary Data	Hex Data
0	0110 1101 1011 0110 1110 1101 1011 0110	60B6E0B6
20	1101 1011 0110 1101 1011 0110 1101 1011	0B60B60B
40	0111 0110 1101 1101 1110 1101 1011 0110	76DB6DB6
60		

To Apply Bit Errors to an Existing Data Pattern User File

This example demonstrates how to apply bit errors to an existing data pattern user file. If you have not created and stored a data pattern user file, first complete the steps in the previous section, [“Creating a Data Pattern User File with the Bit File Editor” on page 161.](#)

1. Press **Apply Bit Errors**.
2. Press **Bit Errors > 5 > Enter**.
3. Press **Apply Bit Errors**.
Notice both **Bit Errors** softkeys change value as they are linked.

Using an Externally Supplied Data Pattern

In this procedure, an external real time data pattern is supplied through DATA, DATA CLOCK, and SYMBOL SYNC connectors.

1. Press **Preset**.
2. Press **Mode > Custom > Real Time I/Q Baseband > Data > Ext**.
3. Connect the real-time data to the DATA input.
4. Connect the data clock trigger signal to DATA CLOCK input.
5. Connect the symbol sync trigger to the SYMBOL SYNC input.

Working with Burst Shapes

- [“Configuring the Burst Rise and Fall Parameters” on page 166](#)
- [“Using User-Defined Burst Shape Curves” on page 166](#)

The Burst Shape menu enables you to modify the rise and fall time, rise and fall delay, and the burst shape (either sine or user file defined). In addition, you can define the shape of the burst and preview the burst shape through a Rise Shape Editor, or restore all of the burst shape parameters back to their original default state.

Rise time	the period of time, specified in bits, where the burst increases from a minimum of -70 dB (0) to full power (1).
Fall time	the period of time, specified in bits, where the burst decreases from full power (1) to a minimum of -70 dB (0).
Rise delay	the period of time, specified in bits, that the start of the burst rise is delayed. Rise delay can be either negative or positive. Entering a delay other than zero shifts the full power point earlier or later than the beginning of the first useful symbol.
Fall delay	the period of time, specified in bits, that the start of the burst fall is delayed. Fall delay can be either negative or positive. Entering a delay other than zero shifts the full power point earlier or later than the end of the last useful symbol.
User-defined burst shape	up to 256 user-entered values, which define the shape of the curve in the specified rise or fall time. The values can vary between 0 (no power) and 1 (full power) and are scaled linearly. Once specified, the values are resampled as necessary to create the cubic spline that passes through all of the sample points.

The default burst shape of each format is implemented according to the standards of the format selected. You can, however, modify the following aspects of the burst shape:

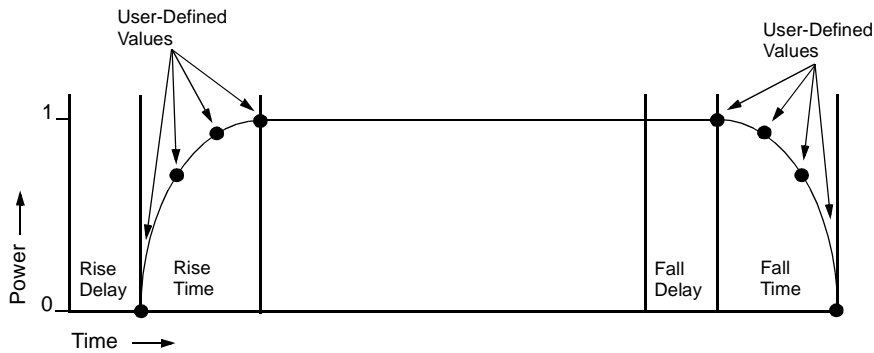

Burst shape maximum rise and fall time values are affected by the following factors:

- the symbol rate
- the modulation type

When the rise and fall delays equal 0, the burst shape attempts to synchronize the maximum burst shape power to the beginning of the first valid symbol and the ending of the last valid symbol.

If you find that the error vector magnitude (EVM) or adjacent channel power (ACP) increases when you turn bursting on, you can adjust the burst shape to assist with troubleshooting.

Configuring the Burst Rise and Fall Parameters

1. Press **Preset**.
2. Press **Mode > Custom > Real Time I/Q Baseband > Burst Shape**.
3. Press **Rise Time > 5 > bits**.
4. Press **Rise Delay > 1 > bits**.
5. Press **Fall Time > 5 > bits**.
6. Press **Fall Delay > 1 > bits**.

This configures the burst shape for the custom real-time I/Q baseband digital modulation format. For instructions on creating and applying user-defined burst shape curves, see [“To Create and Store User-Defined Burst Shape Curves” on page 167](#).

Using User-Defined Burst Shape Curves

You can adjust the shape of the rise time curve and the fall time curve using the Rise Shape and Fall Shape editors. Each editor enables you to enter up to 256 values, equidistant in time, to define the shape of the curve. The values are then resampled to create the cubic spline that passes through all of the sample points.

The Rise Shape and Fall Shape editors are available for custom real-time I/Q baseband generator waveforms. They are not available for waveforms generated by the dual arbitrary waveform generator.

You can also design burst shape files externally and download the data to the signal generator. For more information, see the *E8257D/67D PSG Signal Generators Programming Guide*.

To Create and Store User-Defined Burst Shape Curves

Using this procedure, you learn how to enter rise shape sample values and mirror them as fall shape values to create a symmetrical burst curve.

1. Press **Preset**.
2. Press **Mode > Custom > Real Time I/Q Baseband > Burst Shape**.
3. Press **Define User Burst Shape > More (1 of 2) > Delete All Rows > Confirm Delete Of All Rows**.
4. Enter values similar to the sample values in the following table:

Rise Shape Editor			
Sample	Value	Sample	Value
0	0.000000	5	0.900000
1	0.400000	6	0.950000
2	0.600000	7	0.980000
3	0.750000	8	0.990000
4	0.830000	9	1.000000

- a. Highlight the value (1.000000) for sample 1.
- b. Press **.4 > Enter**.
- c. Press **.6 > Enter**.
- d. Enter the remaining values for samples 3 through 9 from the table above.
- e. Press **More (2 of 2) > Edit Fall Shape > Load Mirror Image of Rise Shape > Confirm Load Mirror Image of Rise Shape**.
This changes the fall shape values to a mirror image of the rise shape values.

Figure 7-1

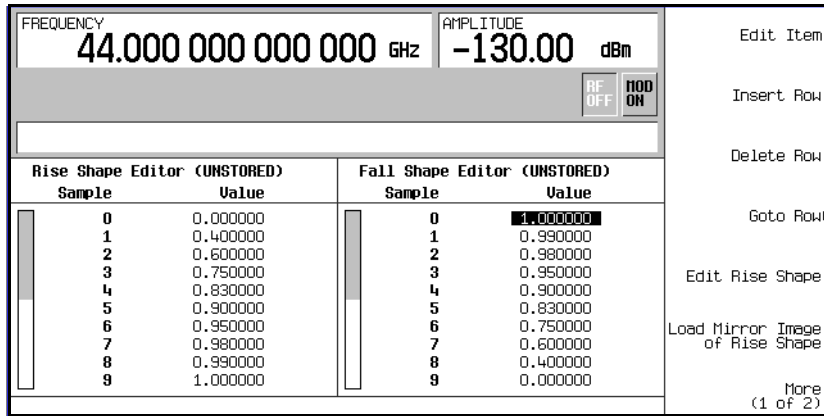

5. Press **More (1 of 2) > Display Burst Shape**.

This displays a graphical representation of the waveform's rise and fall characteristics.

Figure 7-2

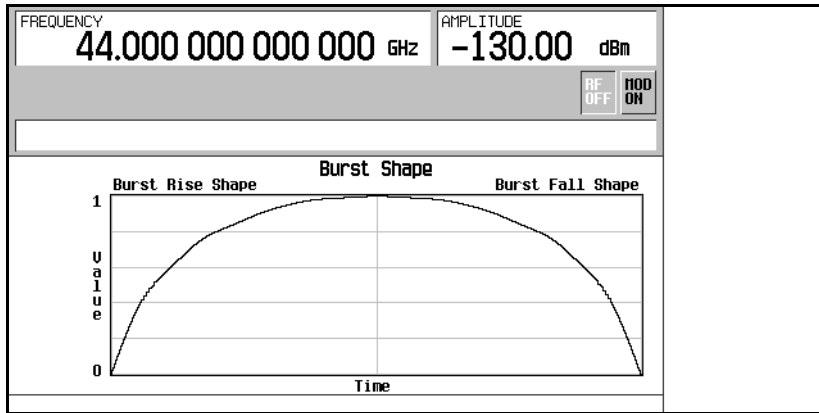

NOTE To return the burst shape to the default conditions, press **Return > Return > Confirm Exit From Table Without Saving > Restore Default Burst Shape**.

6. Press **Return > Load/Store > Store To File**.

If there is already a file name from the Catalog of SHAPE Files occupying the active entry area, press the following keys: **Editing Keys > Clear Text**

7. Enter a file name (for example, NEWBURST) using the alpha keys and the numeric keypad.

8. Press **Enter**.

The contents of the current Rise Shape and Fall Shape editors are stored to the Catalog of SHAPE Files. This burst shape can now be used to customize a modulation or as a basis for a new burst shape design.

To Select and Recall a User-Defined Burst Shape Curve from the Memory Catalog

Once a user-defined burst shape file is stored in the Memory Catalog, it can be recalled for use with real-time I/Q baseband generated digital modulation.

This example requires a user-defined burst shape file stored in memory. If you have not created and stored a user-defined burst shape file, complete the steps in the previous sections.

1. Press **Preset**.
2. Press **Mode > Custom > Real Time I/Q Baseband > Burst Shape > Burst Shape Type > User File**.
3. Highlight the desired burst shape file (for example, **NEWBURST**).
4. Press **Select File**.

The selected burst shape file is now applied to the current real-time I/Q baseband digital modulation state.

5. Press **Return > Custom Off On**.

This generates the custom modulation with user-defined burst shape created in the previous steps. During waveform generation, the **CUSTOM** and **I/Q** annunciators activate. The waveform is now modulating the RF carrier.

6. Press **RF On/Off**.

The current real-time I/Q baseband digital modulation format with user-defined burst shape should be available at the signal generator's **RF OUTPUT** connector.

Configuring Hardware

- [“To Set the BBG Reference” on page 169](#)
- [“To Set the External DATA CLOCK to Receive Input as Either Normal or Symbol” on page 170](#)
- [“To Set the BBG DATA CLOCK to External or Internal” on page 170](#)
- [“To Adjust the I/Q Scaling” on page 170](#)

To Set the BBG Reference

Setting for an External or Internal Reference

1. Press **Mode > Custom > Real Time I/Q Baseband > More (1 of 3) > Configure Hardware**.

Configure Hardware displays a menu where you can set the BBG Reference to **External** or **Internal**.

2. Press **BBG Ref Ext Int** to select either external or internal as the bit-clock reference for the data generator.

If external is selected, apply the reference frequency to the rear-panel BASEBAND GEN REF IN connector.

Setting the External Frequency

The BBG reference external frequency is used only when the **BBG Ref Ext Int** softkey has been set to Ext (external).

1. Press **Mode > Custom > Real Time I/Q Baseband > More (1 of 3) > Configure Hardware**.
Configure Hardware displays a menu where you can set the external BBG reference frequency.
2. Press **Ext BBG Ref Freq**.
3. Use the numeric keypad to a desired frequency, then press **MHz, kHz, or Hz**.

To Set the External DATA CLOCK to Receive Input as Either Normal or Symbol

1. Press **Mode > Custom > Real Time I/Q Baseband > More (1 of 3) > Configure Hardware**.
Configure Hardware allows you to access a menu from which you can set the external DATA CLOCK to receive input as either Normal or Symbol.
2. Press **Ext Data Clock** to select either Normal or Symbol; this setting has no effect in internal clock mode.
 - When set to Normal, the DATA CLOCK input connector requires a bit clock.
 - When set to Symbol, a one-shot or continuous symbol sync signal must be provided to the SYMBOL SYNC input connector.

To Set the BBG DATA CLOCK to External or Internal

1. Press **Mode > Custom > Real Time I/Q Baseband > More (1 of 3) > Configure Hardware**.
Configure Hardware allows you to access a menu from which you can set the BBG DATA CLOCK to receive input from External or Internal.
2. Press **BBG Data Clock Ext Int** to select either external or internal.
 - When set to Ext (external), the DATA CLOCK connector is used to supply the BBG Data Clock.
 - When set to Int (internal), the internal data clock is used.

To Adjust the I/Q Scaling

Adjusting the I/Q Scaling (amplitude of the I/Q outputs) multiplies the I and Q data by the I/Q scaling factor that is selected and can be used to improve the Adjacent Channel Power (ACP). Lower scaling values equate to better ACP. This setting has no effect with MSK or FSK modulation.

1. Press **Mode > Custom > Real Time I/Q Baseband > More (1 of 3) > Configure Hardware**.
Configure Hardware allows you to access a menu from which you can adjust the I/Q Scaling.
2. Press **I/Q Scaling**, enter a desired I/Q scaling level, and press **%**.

Working with Phase Polarity

To Set Phase Polarity to Normal or Inverted

1. Press **Mode > Custom > Real Time I/Q Baseband > More (1 of 3) > Phase Polarity Normal Invert**.

Phase Polarity Normal Invert enables you to either leave the selection as Normal (so that the phase relationship between the I and Q signals is not altered by the phase polarity function), or set to Invert and invert the internal Q signal, reversing the rotation direction of the phase modulation vector.

When you choose Invert, the in-phase component lags the quadrature-phase component by 90° in the resulting modulation. Inverted phase polarity is required by some radio standards and it is useful for lower sideband mixing applications. The inverted selection also applies to the I, I-bar, Q, and Q-bar output signals.

Working with Differential Data Encoding

The Diff Data Encode Off On menu enables you to toggle the operational state of the signal generator's differential data encoding.

- When set to Off, data bits are not encoded prior to modulation.
- When set to On, data bits are encoded prior to modulation. Differential encoding uses an exclusive-OR function to generate a modulated bit. Modulated bits will have a value of 1 if a data bit is different from the previous bit or they will have a value of 0 if a data bit is the same as the previous bit.

This section provides information about the following:

- [Understanding Differential Encoding](#)
- [“Using Differential Encoding” on page 175](#)

Understanding Differential Encoding

Differential encoding is a digital-encoding technique whereby a binary value is denoted by a signal *change* rather than a particular signal state. Using differential encoding, binary data in any user-defined I/Q or FSK modulation can be encoded during the modulation process via symbol table offsets defined in the Differential State Map.

For example, consider the signal generator's default 4QAM I/Q modulation. With a user-defined modulation based on the default 4QAM template, the I/Q Values editor contains data that represent four symbols (00, 01, 10, and 11) mapped into the I/Q plane using two distinct values, 1.000000 and -1.000000. These four symbols can be differentially encoded during the modulation process by assigning symbol table offset values associated with each data value. [Figure 7-3 on page 172](#) shows the 4QAM modulation in the I/Q Values editor.

Figure 7-3

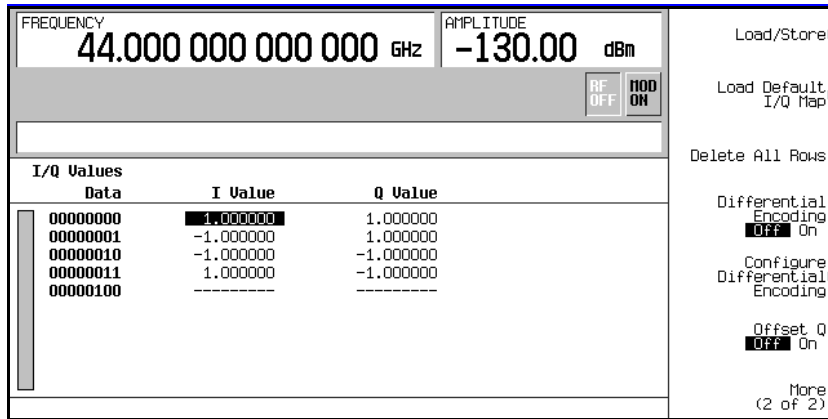

NOTE The number of bits per symbol can be expressed using the following formula. Because the equation is a ceiling function, if the value of x contains a fraction, x is rounded up to the next whole number.

$$x = \lceil \log_2(y) \rceil$$

Where x = bits per symbol, and y = the number of differential states.

The following illustration shows a 4QAM modulation I/Q State Map.

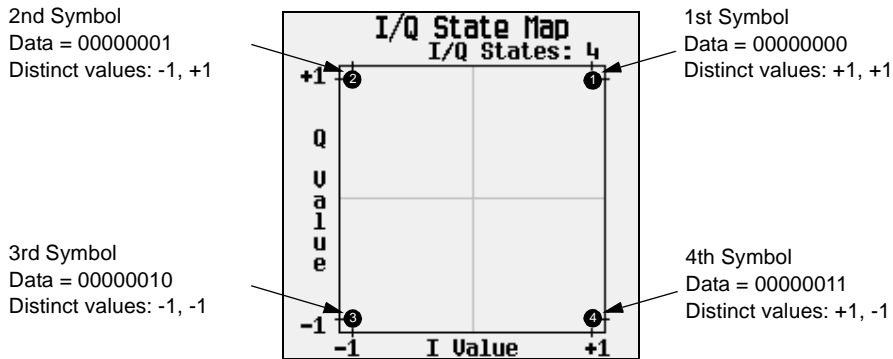

Differential Data Encoding

In real-time I/Q baseband digital modulation waveforms, data (1's and 0's) are encoded, modulated onto a carrier frequency and subsequently transmitted to a receiver. In contrast to differential encoding, differential data encoding modifies the data stream *prior* to I/Q mapping. Where differential encoding encodes the raw data by using symbol table offset values to manipulate I/Q

mapping at the point of modulation, differential data encoding uses *the transition from one bit value to another* to encode the raw data.

Differential data encoding modifies the raw digitized data by creating a secondary, encoded data stream that is defined by *changes* in the digital state, from 1 to 0 or from 0 to 1, of the raw data stream. This differentially encoded data stream is then modulated and transmitted.

In differential data encoding, a *change* in a raw data bit's digital state, from 1 to 0 or from 0 to 1, produces a 1 in the encoded data stream. *No change* in digital state from one bit to the next, in other words a bit with a value of 1 followed by another bit with a value of 1 or a bit with a value of 0 followed by the same, produces a 0 in the encoded data. For instance, differentially encoding the data stream containing 01010011001010 renders 11110101111.

Differential data encoding can be described by the following equation:

$$transmittedbit(i) = databit(i - 1) \oplus databit(i)$$

For a bit-by-bit illustration of the encoding process, see the following illustration:

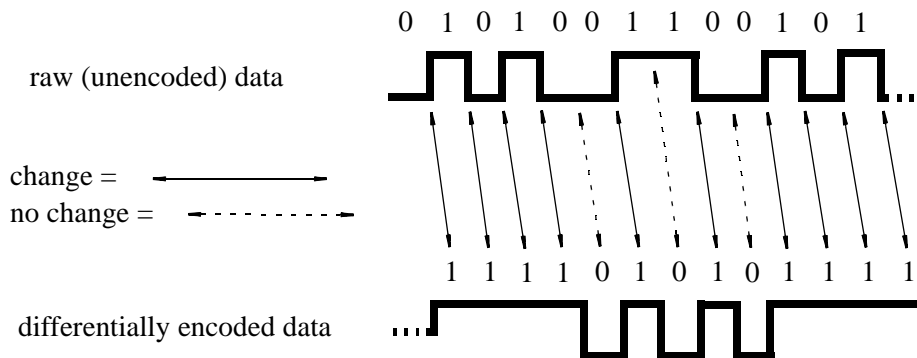

How Differential Encoding Works

Differential encoding employs offsets in the symbol table to encode user-defined modulation schemes. The Differential State Map editor is used to introduce symbol table offset values, which in turn cause transitions through the I/Q State Map based on their associated data value. Whenever a data value is modulated, the offset value stored in the Differential State Map is used to encode the data by transitioning through the I/Q State Map in a direction and distance defined by the symbol table offset value.

Entering a value of +1 causes a 1-state forward transition through the I/Q State Map. As an example, consider the following data/symbol table offset values. These symbol table offsets result in one of the transitions shown.

NOTE The following I/Q State Map illustrations show all possible state transitions using a particular symbol table offset value. The actual state-to-state transition depends on the state in which the modulation starts.

Example	Data	Offset Value
1	00000000	+1
2	00000001	-1
3	00000010	+2
4	00000011	0

Example 1
transition 1 state forward

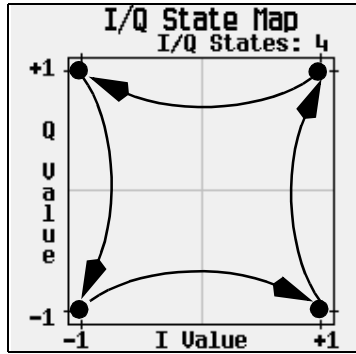

Example 2
transition 1 state backward

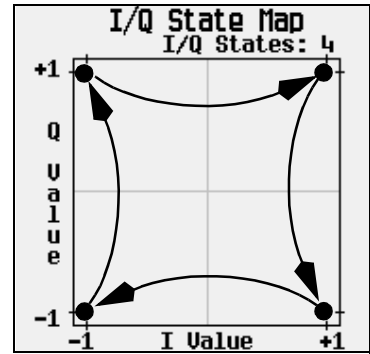

Example 3
transition 2 states forward

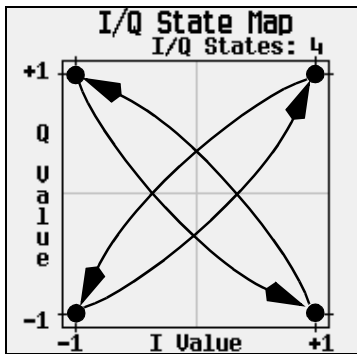

Example 4
no transition

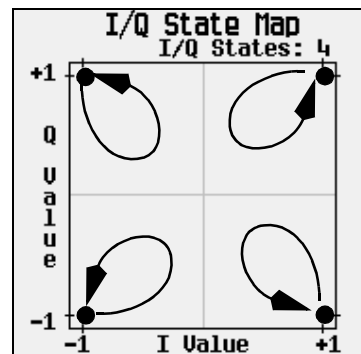

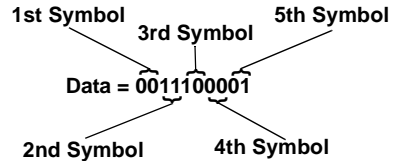
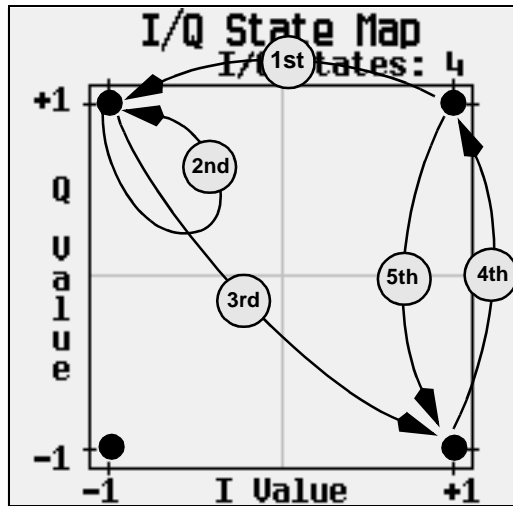

Data Value	Symbol Table Offset
00	+1
01	-1
10	+2
11	+0

When applied to the user-defined default 4QAM I/Q map, starting from the 1st symbol (data 00), the differential encoding transitions for the data stream (in 2-bit symbols) 0011100001 appear in the previous illustration.

As you can see, the 1st and 4th symbols, having the same data value (00), produce the same state transition (forward 1 state). In differential encoding, symbol values do not define location; they define the direction and distance of a *transition* through the I/Q State Map.

For instructions on configuring differential encoding, see [“Understanding Differential Encoding” on page 171](#).

Using Differential Encoding

Differential encoding is a digital-encoding technique that denotes a binary value by a signal *change* rather than a particular signal state. It is available for Custom Real Time I/Q Baseband mode. It is not available for waveforms generated by Arb Waveform Generator mode.

The signal generator’s Differential State Map editor enables you to modify the differential state map associated with user-defined I/Q and user-defined FSK modulations. In this procedure, you create a user-defined I/Q modulation and then configure, activate, and apply differential encoding to the user-defined modulation. For more information, see [“Understanding Differential Encoding” on page 171](#).

This section includes information on following:

- [Configuring User-Defined I/Q Modulation](#)
- [“Accessing the Differential State Map Editor” on page 176](#)
- [“Editing the Differential State Map” on page 177](#)

Configuring User-Defined I/Q Modulation

1. Press Preset.
2. Press Mode > Custom > Real Time I/Q Baseband > Modulation Type > Define User I/Q > More (1 of 2) > Load Default I/Q Map > QAM > 4QAM.

This loads a default 4QAM I/Q modulation and displays it in the I/Q Values editor. The default 4QAM I/Q modulation contains data that represent 4 symbols (00, 01, 10, and 11) mapped into the I/Q plane using 2 distinct values (1.000000 and -1.000000). These 4 symbols will be traversed during the modulation process by the symbol table offset values associated with each symbol of data.

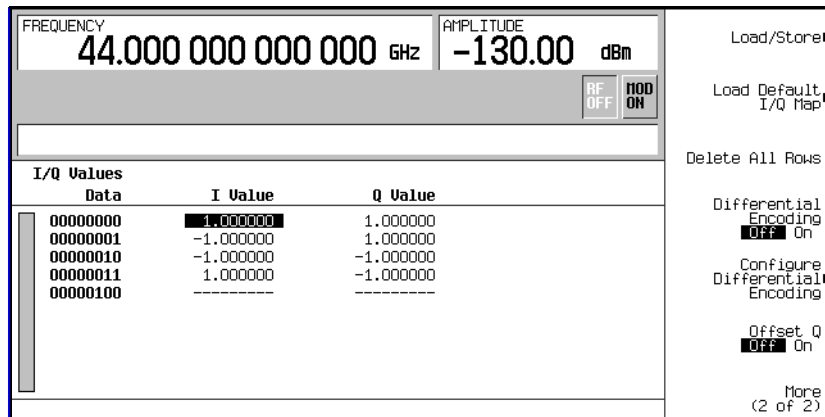

Accessing the Differential State Map Editor

- Press Configure Differential Encoding.

This opens the Differential State Map editor. At this point, you see the data for the 1st symbol (00000000) and the cursor prepared to accept an offset value. You are now prepared to create a custom differential encoding for the user-defined default 4QAM I/Q modulation.

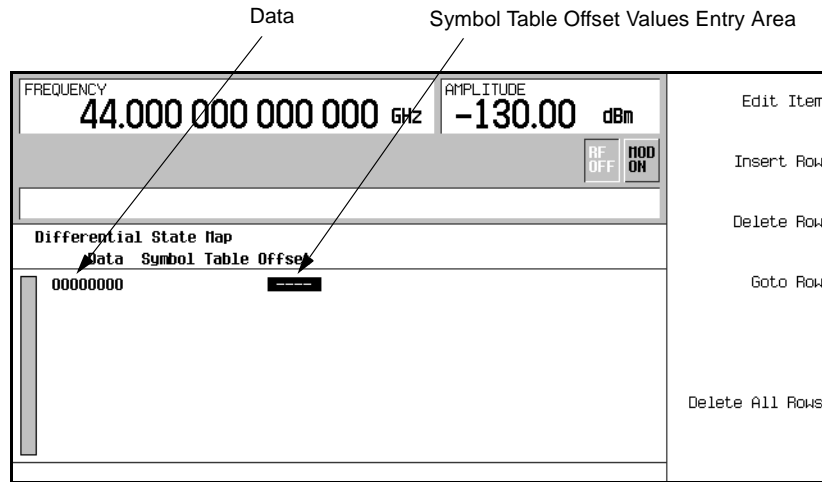

Editing the Differential State Map

1. Press 1 > Enter.

This encodes the first symbol by adding a symbol table offset of 1. The symbol rotates *forward* through the state map by 1 value when a data value of 0 is modulated.

2. Press +/- > 1 > Enter.

This encodes the second symbol by adding a symbol table offset of -1. The symbol rotates *backward* through the state map by 1 value when a data value of 1 is modulated.

NOTE At this point, the modulation has one bit per symbol. For the first two data values (00000000 and 00000001) only the last bits (the 0 and the 1, respectively) are significant.

3. Press 2 > Enter.

This encodes the third symbol by adding a symbol table offset of 2. The symbol rotates *forward* through the state map by 2 values when a data value of 10 is modulated.

4. Press 0 > Enter.

This encodes the fourth symbol by adding a symbol table offset of 0. The symbol does *not* rotate through the state map when a data value of 11 is modulated.

NOTE At this point, the modulation has two bits per symbol. For the data values 00000000, 00000001, 00000010, 00000011, the symbol values are 00, 01, 10, and 11 respectively.

5. Press **Return > Differential Encoding Off On.**

This applies the custom differential encoding to a user-defined modulation.

NOTE Notice that (UNSTORED) appears next to Differential State Map on the signal generator's display. Differential state maps are associated with the user-defined modulation for which they were created.

To save a custom differential state map, you must store the user-defined modulation for which it was designed. Otherwise the symbol table offset data is purged when you press the **Confirm Exit From Table Without Saving** softkey when exiting from the I/Q or FSK editor.

8 Multitone Waveform Generator

In the following sections, this chapter describes the multitone mode, which is available only in E8267D PSG Vector Signal Generators with Option 601 or 602:

- “Overview” on page 179
- “Creating, Viewing, and Optimizing Multitone Waveforms” on page 180

See also: Chapter 3, “Basic Digital Operation,” on page 67

Overview

The multitone mode builds a waveform that has up to 64 CW signals, or tones. Using the Multitone Setup table editor, you can define, modify, and store waveforms for playback. Multitone waveforms are generated by the internal I/Q baseband generator.

The multitone waveform generator is typically used for testing the intermodulation distortion characteristics of multi-channel devices, such as mixers or amplifiers. Intermodulation distortion (IMD) occurs when non-linear devices with multiple input frequencies cause unwanted outputs at other frequencies or interfere with adjacent channels. The multitone waveform generator supplies a waveform with a user-specified number of tones whose IMD products can be measured using a spectrum analyzer and used as a reference when measuring the IMD generated by a device-under-test.

Multitone waveforms are created using the internal I/Q baseband generator and stored in ARB memory for playback. Although the multitone mode generates a high-quality waveform, a small amount of IMD, carrier feedthrough, and feedthrough-related IMD occurs. Carrier feedthrough may be observed when an even number of tones are generated, since there are no tones at the center carrier frequency to mask the feedthrough. To minimize carrier feedthrough for an even-numbered multitone signal, it is necessary to manually adjust the I and Q offsets while observing the center carrier frequency with a spectrum analyzer.

For measurements that require more than 64 tones or the absence of IMD and carrier feedthrough, you can create up to 1024 distortion-free multitone signals using Agilent Technologies Signal Studio software Option 408.

NOTE For more information about multitone waveform characteristics and the PSG vector signal generator multitone format, download *Application Note 1410* from our website by going to <http://www.agilent.com> and searching for “AN 1410” in Test & Measurement.

Creating, Viewing, and Optimizing Multitone Waveforms

This section describes how to set up, generate, and optimize a multitone waveform while viewing it with a spectrum analyzer. Although you can view a generated multitone signal using any spectrum analyzer that has sufficient frequency range, an Agilent Technologies PSA high-performance spectrum analyzer was used for this demonstration. Before generating your signal, connect the spectrum analyzer to the signal generator as shown in [Figure 8-1](#).

Figure 8-1 Spectrum Analyzer Setup

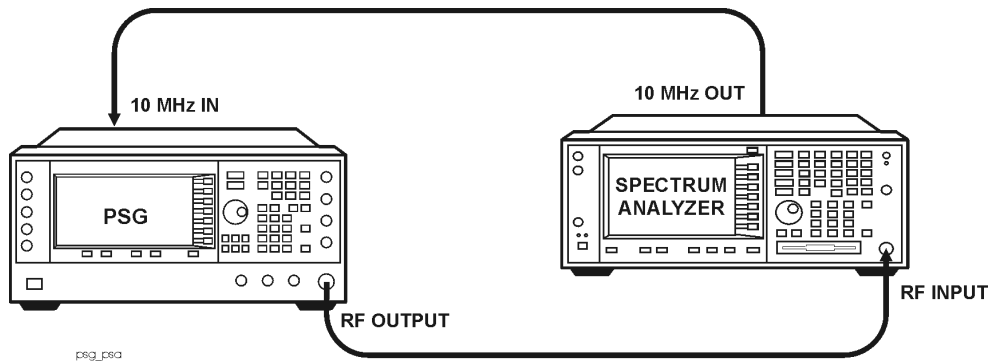

To Create a Custom Multitone Waveform

Using the Multitone Setup table editor, you can define, modify and store user-defined multitone waveforms. Multitone waveforms are generated by the dual arbitrary waveform generator.

1. Preset the signal generator.
2. Set the signal generator RF output frequency to 20 GHz.
3. Set the signal generator RF output amplitude to 0 dBm.
4. Press **Mode** > **Multitone** > **Initialize Table** > **Number of Tones** > **9** > **Enter**.
5. Press **Freq Spacing** > **1** > **MHz**.
6. Press **Initialize Phase Fixed Random** to **Random**.
7. Press **Done**.
8. Press **Multitone Off On** to **On**.
9. Turn on the RF output.

The multitone signal should be available at the signal generator RF OUTPUT connector.

[Figure 8-2](#) shows what the signal generator display should look like after all steps have been completed. Notice that the M-TONE, I/Q, RF ON, and MOD ON annunciators are displayed and the parameter settings for the signal are shown in the status area of the signal generator display. The multitone waveform is stored in volatile ARB memory.

The waveform has nine tones spaced 1 MHz apart with random initial phase values. The center tone is placed at the carrier frequency, while the other eight tones are spaced in 1 MHz increments from the center tone. If you create an even number of tones, the carrier frequency will be centered between the two middle tones.

Figure 8-2

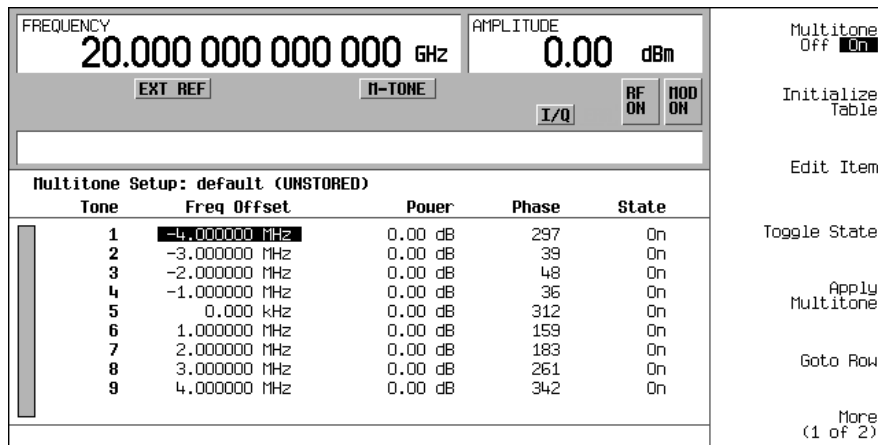

To View a Multitone Waveform

This procedure describes how to configure the spectrum analyzer to view a multitone waveform and its IMD products. Actual key presses will vary, depending on the model of spectrum analyzer you are using.

1. Preset the spectrum analyzer.
2. Set the carrier frequency to 20 GHz.
3. Set the frequency span to 20 MHz.
4. Set the amplitude for a 10 dB scale with a 4 dBm reference.
5. Adjust the resolution bandwidth to sufficiently reduce the noise floor to expose the IMD products. A 9.1 kHz setting was used in our example.
6. Turn on the peak detector.
7. Set the attenuation to 14 dB, so you're not overdriving the input mixer on the spectrum analyzer.

You should now see a waveform with nine tones and a 20 GHz center carrier frequency that is similar to the one shown in [Figure 8-3](#). You will also see IMD products at 1 MHz intervals above and below the highest and lowest tones.

Figure 8-3

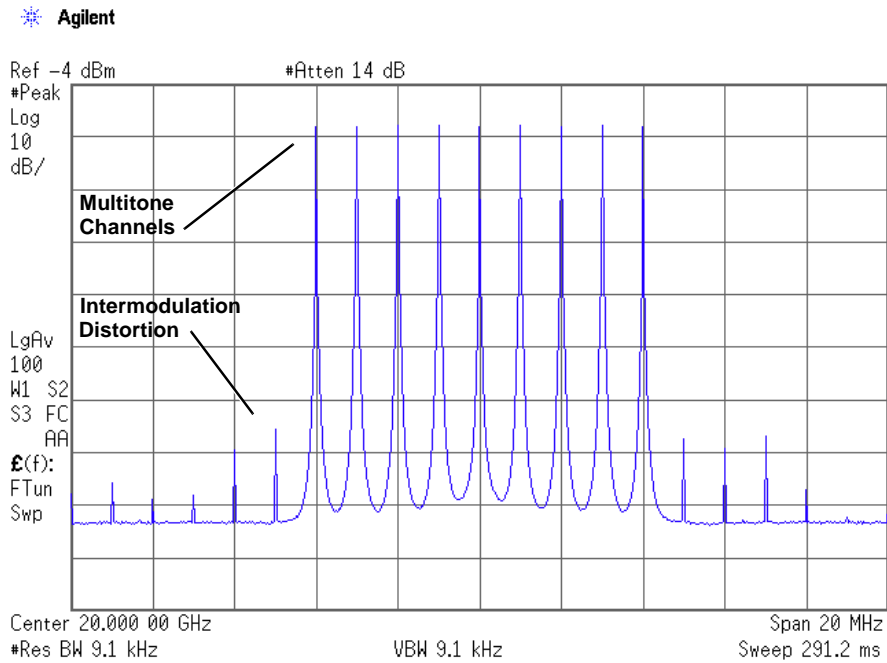

To Edit the Multitone Setup Table

This procedure builds upon the previous procedure.

1. Press **Initialize Table** > **Number of Tones** > **10** > **Enter**.
2. Press **Done**.
3. Highlight the value (On) in the **State** column for the tone in row 2.
4. Press **Toggle State**.
5. Highlight the value (0 dB) in the **Power** column for the tone in row 4.
6. Press **Edit Item** > **-10** > **dB**.
7. Highlight the value (0) in the **Phase** column for the tone in row 4.
8. Press **Edit Item** > **123** > **deg**.

9. Press **Apply Multitone**.

NOTE Whenever a change is made to a setting while the multitone generator is operating (**Multitone Off** set to **On**), you must apply the change by pressing the **Apply Multitone** softkey before the updated waveform will be generated. When you apply a change, the baseband generator creates a multitone waveform using the new settings and replaces the existing waveform in ARB memory.

You have now changed the number of tones to 10, disabled tone 2, and changed the power and phase of tone 4. **Figure 8-4** shows what the multitone setup table display on the signal generator should look like after all steps have been completed. The spectrum analyzer should display a waveform similar to the one shown in **Figure 8-5 on page 184**. Notice that even-numbered multitone waveforms have a small amount of carrier feedthrough at the center carrier frequency.

Figure 8-4

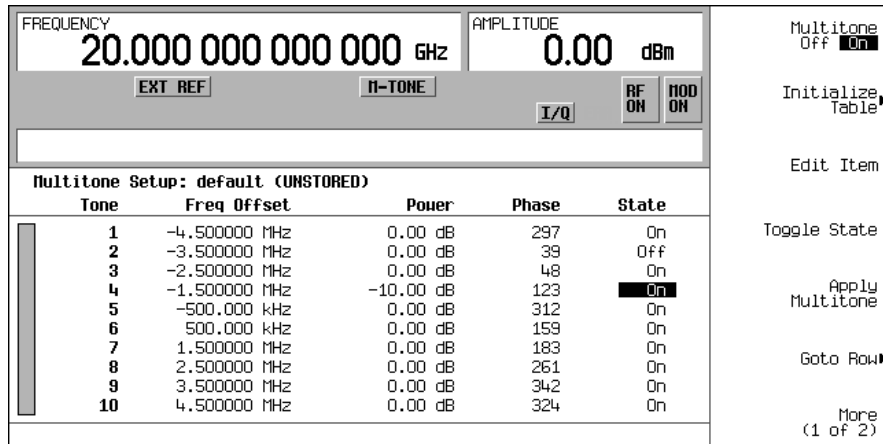
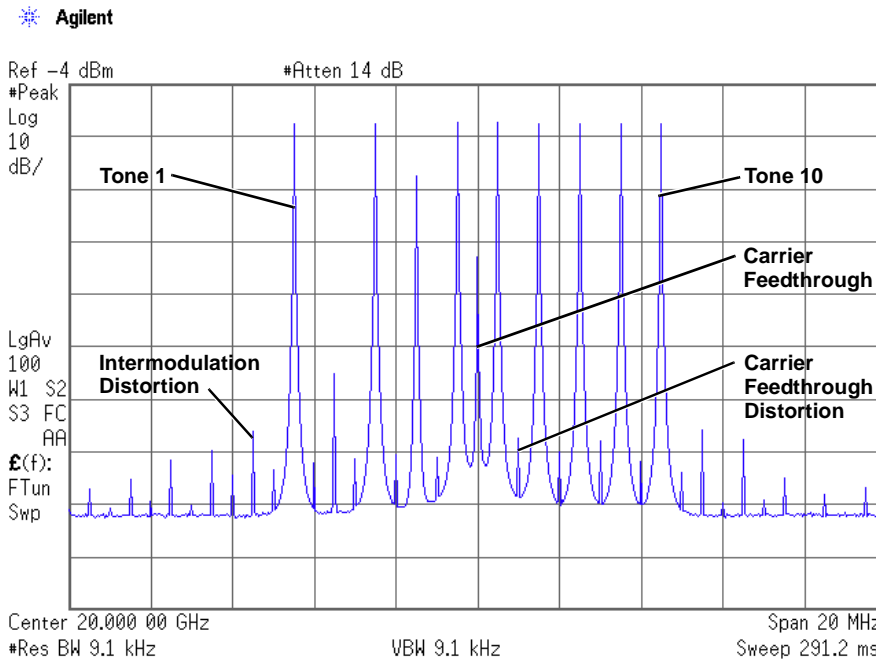

Figure 8-5



To Minimize Carrier Feedthrough

This procedure describes how to minimize carrier feedthrough and measure the difference in power between the tones and their intermodulation products. Carrier feedthrough can only be observed with even-numbered multitone waveforms.

This procedure builds upon the previous procedure.

1. On the spectrum analyzer, set the resolution bandwidth for a sweep rate of about 100-200 ms. This will allow you to dynamically view the carrier feedthrough spike as you make adjustments.
2. On the signal generator, press **I/Q > I/Q Adjustments > I/Q Adjustments Off On** to On.
3. Press **I Offset** and turn the rotary knob while observing the carrier feedthrough with the spectrum analyzer. Changing the I offset in the proper direction will reduce the feedthrough level. Adjust the level as low as possible.
4. Press **Q Offset** and turn the rotary knob to further reduce the carrier feedthrough level.
5. Repeat steps 3 and 4 until you have reached the lowest possible carrier feedthrough level.
6. On the spectrum analyzer, return the resolution bandwidth to its previous setting.

7. Turn on waveform averaging.
8. Create a marker and place it on the peak of one of the end tones.
9. Create a delta marker and place it on the peak of the adjacent intermodulation product, which should be spaced 10 MHz from the marked tone.
10. Measure the power difference between the tone and its distortion product.

You should now see a display that is similar to the one shown in [Figure 8-6](#). Your optimized multitone signal can now be used to measure the IMD products generated by a device-under-test.

Note that carrier feedthrough changes with time and temperature. Therefore, you will need to periodically readjust your I and Q offsets to keep the signal optimized.

Figure 8-6

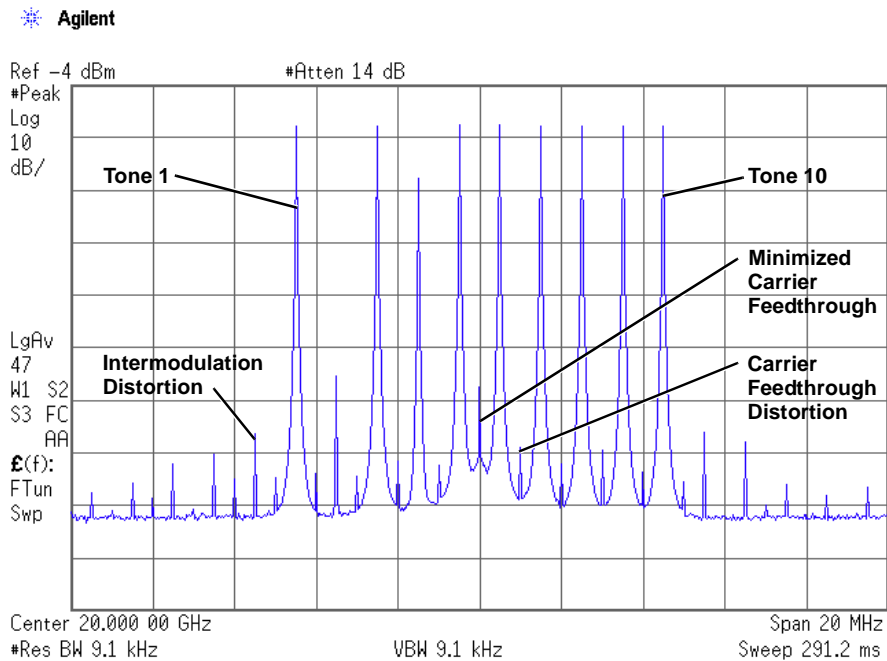

To Determine Peak to Average Characteristics

This procedure describes how to set the phases of the tones in a multitone waveform and determine the peak to average characteristics by plotting the complementary cumulative distribution function (CCDF).

1. Press **Mode > Multitone > Initialize Table > Number of Tones > 64 > Enter**.
2. Press **Freq Spacing > 20 > kHz**.
3. Press **Initialize Phase Fixed Random to Fixed**.

4. Press **Done**.
5. Press **Apply Multitone**.
6. Press **More (1 of 2) > ARB Setup > Waveform Utilities > Waveform Statistics > Plot CCDF**.

You should now see a display that is similar to the one shown in [Figure 8-7](#). The CCDF plot displays the peak to average characteristics of the waveform with all phases set to zero.

Figure 8-7 CCDF Plot with Fixed Phase Set

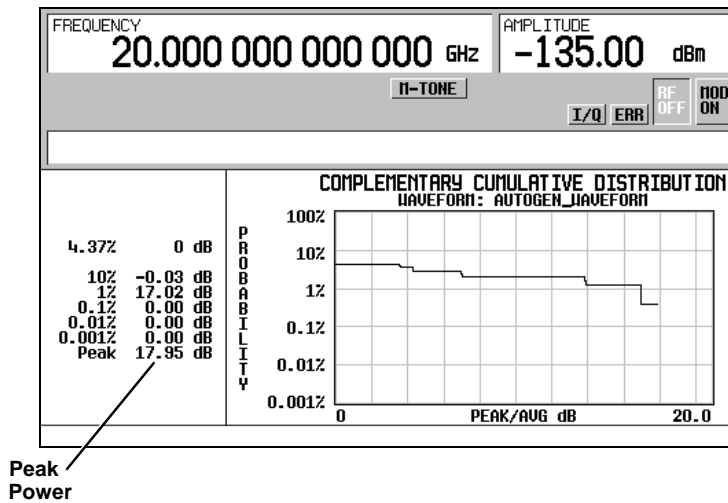

7. Press **Mode Setup > Initialize Table**.
8. Press **Initialize Phase Fixed Random to Random**.
9. Press **Random Seed Fixed Random to Random**.
10. Press **Done**.
11. Press **Apply Multitone**.
12. Press **More (1 of 2) > Waveform Statistics > Plot CCDF**.

You should now see a display that is similar to the one shown in [Figure 8-8](#). The CCDF plot displays the peak to average characteristics of the waveform with randomly generated phases and a random seed.

The random phase setup simulates the typically random nature of multitone waveforms. Notice that randomly distributed phases result in a much lower peak to average ratio than fixed phases. An increase in the number of tones with random phases will decrease the probability of a maximum peak power occurrence.

Figure 8-8 CCDF Plot with Random Phase Set

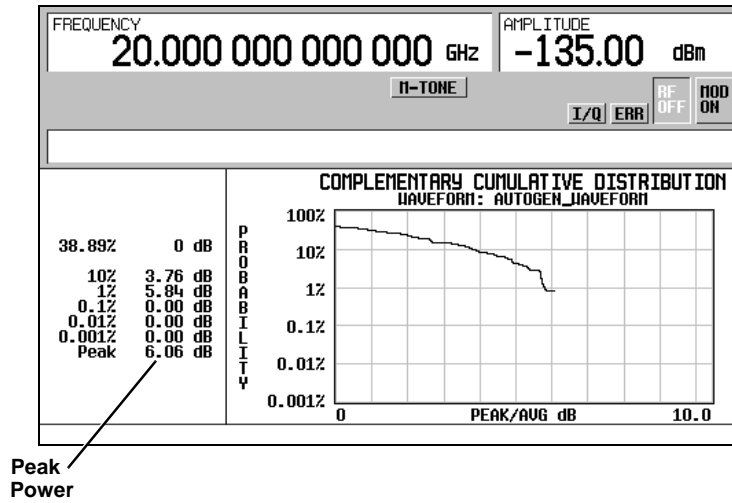

9 Two-Tone Waveform Generator

In the following sections, this chapter describes the two-tone mode, which is available only in E8267D PSG vector signal generators with Option 601 or 602:

- “Overview” on page 189
- “Creating, Viewing, and Modifying Two-Tone Waveforms” on page 189

See also: “Arbitrary (ARB) Waveform File Headers” on page 68

Overview

The two-tone mode builds a waveform that has two equal-powered CW signals, or tones. The default waveform has two tones that are symmetrically spaced from the center carrier frequency, and have user-defined amplitude, carrier frequency, and frequency separation settings. The user can also align the tones left or right, relative to the carrier frequency.

The two-tone waveform generator is designed for testing the intermodulation distortion characteristics of non-linear devices, such as mixers or amplifiers. Intermodulation distortion (IMD) occurs when non-linear devices with multiple input frequencies interfere with adjacent channels or cause unwanted outputs at other frequencies. The two-tone waveform generator supplies a signal whose IMD products can be measured using a spectrum analyzer and used as a reference when measuring the IMD generated by a device-under-test.

Two-tone waveforms are created using the internal I/Q baseband generator and stored in ARB memory for playback. Although the two-tone mode generates a high-quality waveform, a small amount of IMD occurs. In addition to IMD, a small amount of carrier feedthrough and feedthrough-related IMD may be present when the spacing between the tones is centered on the carrier frequency. To minimize carrier feedthrough for a two-tone signal, you must manually adjust the I and Q offsets while observing the center carrier frequency with a spectrum analyzer. For measurements that require the absence of IMD and carrier feedthrough, you can create distortion-free multitone signals using Agilent Technologies’ Signal Studio software Option 408.

NOTE For more information about two-tone waveform characteristics and the E8257D/67D PSG Vector Signal Generator two-tone format, download *Application Note 1410* from our website by going to <http://www.agilent.com> and searching for “AN 1410” in Test & Measurement.

Creating, Viewing, and Modifying Two-Tone Waveforms

This section describes how to set up, generate, and modify a two-tone waveform while viewing it with a spectrum analyzer. Although you can view a generated two-tone signal using any spectrum analyzer that has sufficient frequency range, an Agilent Technologies PSA Series High-Performance Spectrum Analyzer was used for this demonstration. Before generating your signal, connect the spectrum analyzer to the signal generator as shown in [Figure 9-1](#).

Figure 9-1

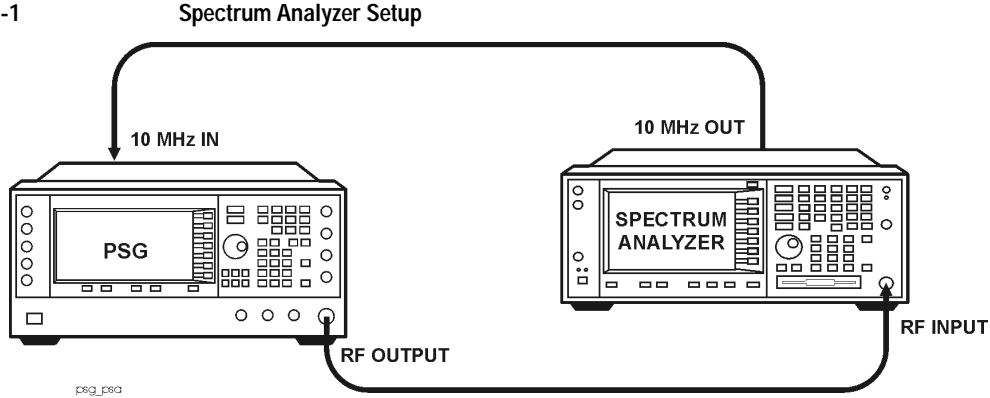

To Create a Two-Tone Waveform

This procedure describes how to create and a basic, center-aligned, two-tone waveform.

1. Preset the signal generator.
2. Set the signal generator RF output frequency to 20 GHz.
3. Set the signal generator RF output amplitude to 0 dBm.
4. Press **Mode** > **Two Tone** > **Freq Separation** > **10** > **MHz**.
5. Press **Two Tone Off On** to **On**.
6. Turn on the RF output.

The two-tone signal is now available at the signal generator RF OUTPUT connector. [Figure 9-2 on page 191](#) shows what the signal generator display should look like after all steps have been completed. Notice that the **T-TONE**, **I/Q**, **RF ON**, and **MOD ON** annunciators are displayed and the parameter settings for the signal are shown in the status area of the signal generator display.

Figure 9-2

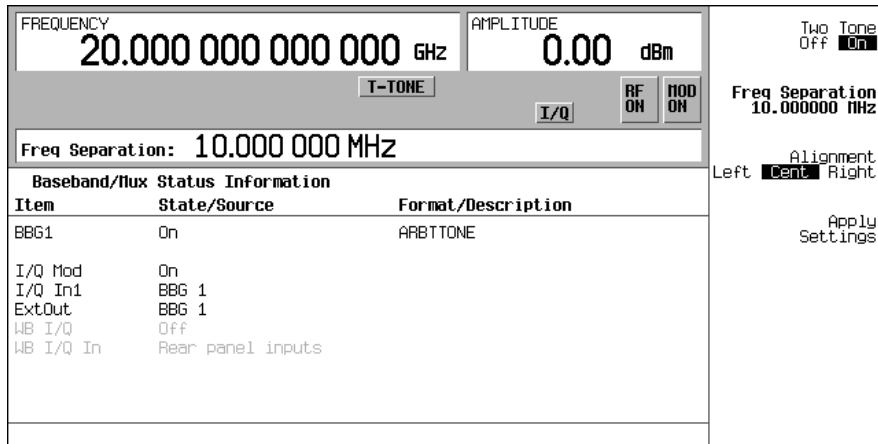

To View a Two-Tone Waveform

This procedure describes how to configure the spectrum analyzer to view a two-tone waveform and its IMD products. Actual key presses will vary, depending on the model of spectrum analyzer you are using.

1. Preset the spectrum analyzer.
2. Set the carrier frequency to 20 GHz.
3. Set the frequency span to 60 MHz.
4. Set the amplitude for a 10 dB scale with a 4 dBm reference.
5. Adjust the resolution bandwidth to sufficiently reduce the noise floor to expose the IMD products. A 9.1 kHz setting was used in our example.
6. Turn on the peak detector.
7. Set the attenuation to 14 dB, so you're not overdriving the input mixer on the spectrum analyzer.

You should now see a two-tone waveform with a 20 GHz center carrier frequency that is similar to the one shown in [Figure 9-3 on page 192](#). You will also see IMD products at 10 MHz intervals above and below the generated tones, and a carrier feedthrough spike at the center frequency with carrier feedthrough distortion products at 10 MHz intervals above and below the center carrier frequency.

Figure 9-3

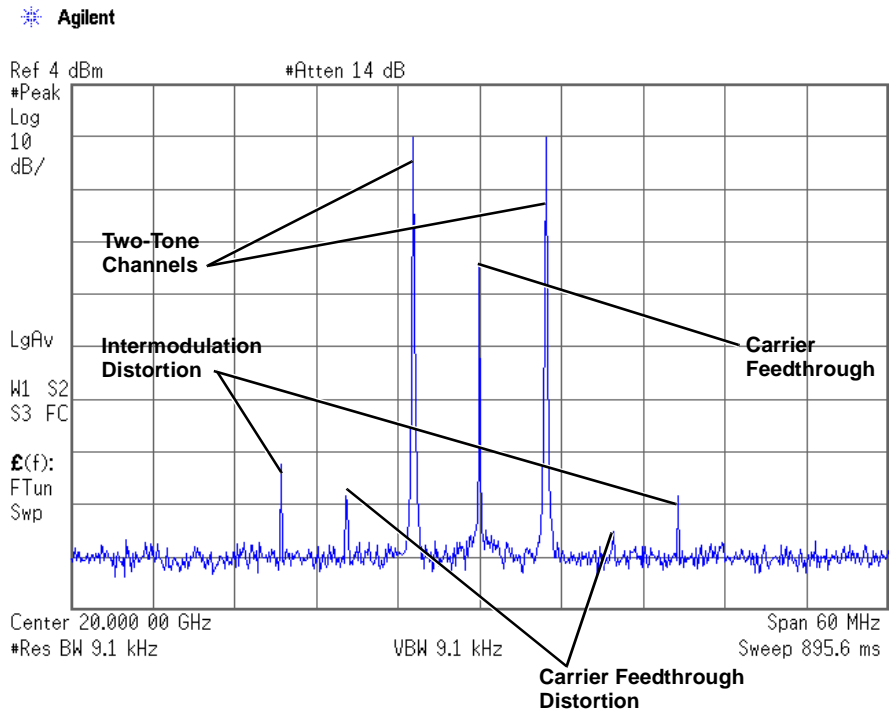

To Minimize Carrier Feedthrough

This procedure describes how to minimize carrier feedthrough and measure the difference in power between the tones and their intermodulation distortion products. Carrier feedthrough only occurs with center-aligned two-tone waveforms.

This procedure builds upon the previous procedure.

1. On the spectrum analyzer, set the resolution bandwidth for a sweep rate of about 100-200 ms. This will allow you to dynamically view the carrier feedthrough spike as you make adjustments.
2. On the signal generator, press **I/Q > I/Q Adjustments > I/Q Adjustments Off On** to On.
3. Press **I Offset** and turn the rotary knob while observing the carrier feedthrough with the spectrum analyzer. Changing the I offset in the proper direction will reduce the feedthrough level. Adjust the level as low as possible.
4. Press **Q Offset** and turn the rotary knob to further reduce the carrier feedthrough level.
5. Repeat steps 3 and 4 until you have reached the lowest possible carrier feedthrough level.

6. On the spectrum analyzer, return the resolution bandwidth to its previous setting.
7. Turn on waveform averaging.
8. Create a marker and place it on the peak of one of the two tones.
9. Create a delta marker and place it on the peak of the adjacent intermodulation product, which should be spaced 10 MHz from the marked tone.
10. Measure the power difference between the tone and its distortion product.

You should now see a display that is similar to the one shown in [Figure 9-4 on page 193](#). Your optimized two-tone signal can now be used to measure the IMD products generated by a device-under-test.

Note that carrier feedthrough changes with time and temperature. Therefore, you will need to periodically readjust your I and Q offsets to keep your signal optimized.

Figure 9-4

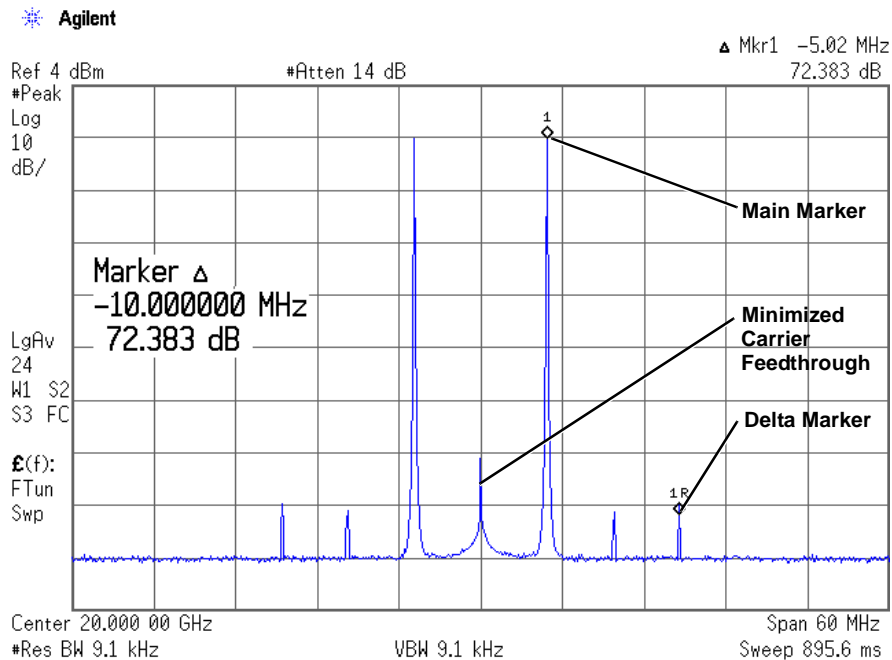

To Change the Alignment of a Two-Tone Waveform

This procedure describes how to align a two-tone waveform left or right, relative to the center carrier frequency. Because the frequency of one of the tones is the same as the carrier frequency, this alignment eliminates carrier feedthrough. However, image frequency interference caused by left or right alignment may cause minor distortion of the two-tone signal. This procedure builds upon the previous procedure.

1. On the signal generator, press **Mode Setup > Alignment Left Cent Right** to **Left**.
2. Press **Apply Settings** to regenerate the waveform.

NOTE Whenever a change is made to a setting while the two-tone generator is operating (**Two Tone Off** set to **On**), you must apply the change by pressing the **Apply Settings** softkey before the updated waveform will be generated. When you apply a change, the baseband generator creates a two-tone waveform using the new settings and replaces the existing waveform in ARB memory.

3. On the spectrum analyzer, temporarily turn off waveform averaging to refresh your view more quickly. You should now see a left-aligned two-tone waveform that is similar to the one shown in [Figure 9-5](#).

Figure 9-5

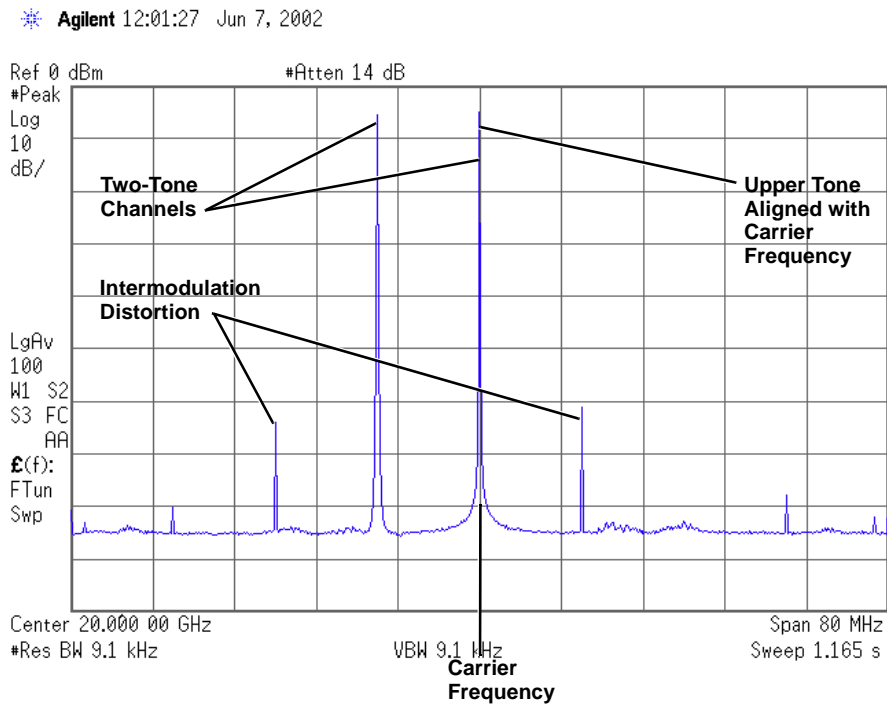

10 AWGN Waveform Generator

In the following sections, this chapter contains examples for using the AWGN waveform generator, which is available only in E8267D vector PSGs with Options 601 or 602 and Option 403:

- [“Arb Waveform Generator AWGN” on page 195](#)
- [“Real Time I/Q Baseband AWGN” on page 196](#)

For adding real-time AWGN to waveforms using the Dual ARB player, see [“Adding Real-Time Noise to a Dual ARB Waveform” on page 82](#)

Configuring the AWGN Generator

The AWGN (additive white Gaussian noise) generator is available for the Arb Waveform Generator mode and the Real Time I/Q Baseband mode. The AWGN generator can be configured with user-defined noise bandwidth, noise waveform length, and noise seed parameters.

- **Bandwidth** – the noise bandwidth can be set from 50 kHz to 15 MHz.
- **Waveform Length** – the waveform length is the length in samples of the noise waveform. Longer waveform lengths provide more statistically correct noise waveforms.
- **Noise Seed** – the noise seed selection can be either random or fixed. The noise seed determines whether the noise waveform data is repeatable (using the fixed selection) or random (using the random selection).

When the AWGN generator is active, an annunciator, labeled AWGN, is displayed on the front panel of the signal generator.

Arb Waveform Generator AWGN

1. Press **Preset**.
2. Press **Mode > More (1 of 2) > AWGN > Arb Waveform Generator AWGN**
3. Press **Bandwidth > 1.25 > MHz**.
4. Press **Waveform Length > 131072**.
5. Press **Noise Seed Fixed Random** until **Random** is highlighted.

This configures a randomly seeded AWGN waveform with a bandwidth of 1.25 MHz and a waveform length of 131072 bits.

Configuring the RF Output

1. Set the RF output frequency to 500 MHz.
2. Set the output amplitude to -10 dBm.
3. Press **RF On/Off**.

Generating the Waveform

Press **AWGN Off On** until **On** is highlighted.

This generates an AWGN waveform with the parameters defined in the previous procedure. During waveform generation, the **AWGN** and **I/Q** annunciators activate and the AWGN waveform is stored in volatile ARB memory. The waveform is now modulating the RF carrier.

Real Time I/Q Baseband AWGN

1. Press **Preset**.
2. Press **Mode > More (1 of 2) > AWGN > Real Time I/Q Baseband AWGN**
3. Press **Bandwidth > 10 > MHz**.

Configuring the RF Output

1. Set the RF output frequency to 500 MHz.
2. Set the output amplitude to -10 dBm.
3. Press **RF On/Off**.

Generating the Waveform

Press **AWGN Off On** until **On** is highlighted.

This generates an AWGN waveform with the parameters defined in the previous procedure. During waveform generation, the **AWGN** and **I/Q** annunciators activate. The waveform is now modulating the RF carrier.

11 Peripheral Devices

This chapter provides information on peripheral devices used with PSG signal generators. The N5102A Baseband Studio digital signal interface module and extended frequency source module operation and features are described in the following sections:

N5102A Digital Signal Interface Module

- “Clock Timing” on page 197
- “Connecting the Clock Source and the Device Under Test” on page 210
- “Data Types” on page 212
- “Operating the N5102A Module in Output Mode” on page 213
- “Operating the N5102A Module in Input Mode” on page 222

Millimeter-Wave Source Modules

- “Using Agilent Millimeter-Wave Source Modules” on page 230
- “Using Other Source Modules” on page 234

N5102A Digital Signal Interface Module

Clock Timing

This section describes how clocking for the digital data is provided. Clock timing information and diagrams are supplied for the different port configurations (serial, parallel, or parallel interleaved data transmission) and phase and skew settings. All settings for the interface module are available on the signal generator user interface (UI).

Clock and Sample Rates

A sample is a group of bits where the size of the sample is set using the **Word Size** softkey. The clock is the signal that tells when the bits of a sample are valid (in a non-transition state). The clock and sample rates are displayed in the first-level and data setup softkey menus. The clock rate and sample rate are usually the same. They will differ when serial mode is selected, or when there are multiple clocks per sample.

Figure 11-1 Data Setup Menu for a Parallel Port Configuration

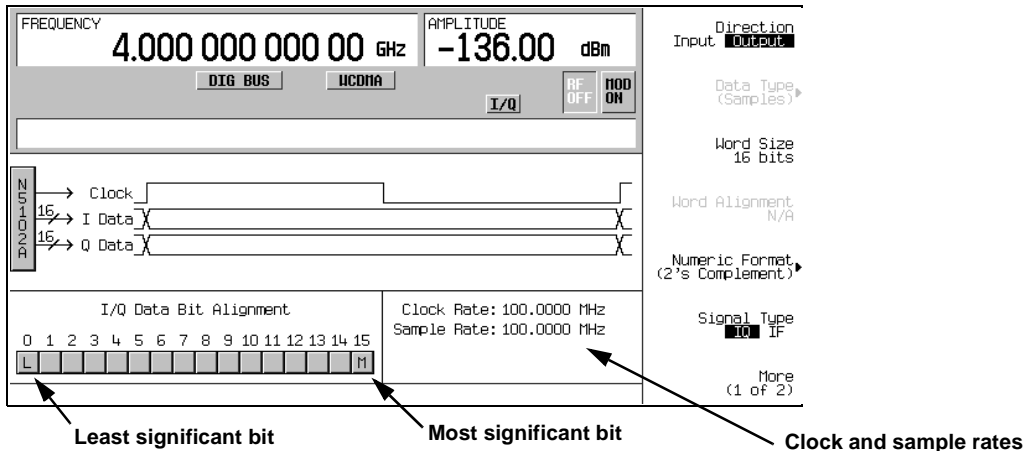

See the PSG User's Guide for information

The N5102A module clock rate is set using the **Clock Rate** softkey and has a range of 1 kHz to 400 MHz. The sample rate is automatically calculated and has a range of 1 kHz to 100 MHz. These ranges can be smaller depending on logic type, data parameters, and clock configuration.

Maximum Clock Rates

The N5102A module maximum clock rate depends on the logic and signal type. [Table 11-1](#) and [Table 11-2](#) show the warranted rates and the maximum clock rates for the various logic and signal types. Notice that LVDS in the output mode using an IF signal is the only logic type where the warranted and maximum rates are the same.

Table 11-1 Warranted Parallel Output Level Clock Rates and Maximum Clock Rates

Logic Type	Warranted Level Clock Rates		Maximum Clock Rates (typical)	
	IQ Signal Type	IF Signal Type ^a	IQ Signal Type	IF Signal Type
LVTTTL and CMOS	100 MHz	100 MHz	150 MHz	150 MHz
LVDS	200 MHz	400 MHz	400 MHz	400 MHz

a. The IF signal type is not available for a serial port configuration.

Table 11-2 Warranted Parallel Input Level Clock Rates and Maximum Clock Rates

Logic Type	Warranted Level Clock Rates	Maximum Clock Rates (typical)
LVTTL and CMOS	100 MHz	100 MHz
LVDS	100 MHz	400 MHz

The levels will degrade above the warranted level clock rates, but they may still be usable.

Serial Port Configuration Clock Rates

For a serial port configuration, the lower clock rate limit is determined by the word size (word size and sample size are synonymous), while the maximum clock rate limit remains constant at 150 MHz for LVTTL and CMOS logic types, and 400 MHz for an LVDS logic type.

The reverse is true for the sample rate. The lower sample (word) rate value of 1 kHz remains while the upper limit of the sample rate varies with the word size. For example, a five-bit sample for an LVTTL or CMOS logic type yields the following values in serial mode:

- Clock rate of 5 kHz through 150 MHz
- Sample rate of 1 kHz through 30 MHz

Refer to [Table 11-3](#) and [Table 11-4](#), for the serial clock rates.

Table 11-3 Output Serial Clock Rates

Logic Type	Minimum Rate	Maximum Rate
LVDS	1 x (word size) kHz	400 MHz
LVTTL and CMOS	1 x (word size) kHz	150 MHz

Table 11-4 Input Serial Clock Rates

Logic Type	Data Type	Minimum Rate	Maximum Rate
LVDS	Samples	1 x (word size) kHz	400
	Pre-FIR Samples	1 x (word size) kHz	the smaller of: 50 ^a x (word size) MHz or 400 MHz
LVTTL and CMOS	N/A	1 x (word size) kHz	150 MHz

a. The maximum sample rate depends on the selected filter when the data rate is Pre-FIR Samples. Refer to [“Input Mode” on page 212](#) for more information.

Parallel and Parallel Interleaved Port Configuration Clock Rates

Parallel and parallel interleaved port configurations have other limiting factors for the clock and sample rates:

- logic type
- Clocks per sample selection
- IQ or IF digital signal type

Clocks per sample (clocks/sample) is the ratio of the clock to sample rate. For an IQ signal type, the sample rate is reduced by the clocks per sample value when the value is greater than one. For an IF signal or an input signal, clocks per sample is always set to one. Refer to [Table 11-5](#) for the Output mode parallel and parallel interleaved port configuration clock rates.

Table 11-5 Output Parallel and Parallel Interleaved Clock Rates

Logic Type	Signal Type	Minimum Rate	Maximum Rate
LVDS	IQ	1 x (clocks/sample) kHz	the smaller of: 100 x (clocks /sample) MHz or 400 MHz
	IF	4 kHz	400 MHz
Other	IQ	1 x (clocks/sample) kHz	the smaller of: 100 x (clocks /sample) MHz or 150 MHz
	IF	4 kHz	150 MHz

For Input mode, the maximum clock rate is limited by the following factors:

- sample size
- data type
- selected filter for Pre-FIR Samples

Refer to [Table 11-6](#) for the Input mode parallel and parallel interleaved port configuration clock rates.

Table 11-6 Input Parallel and Parallel Interleaved Clock Rates

Logic Type	Data Type	Minimum Rate	Maximum Rate
N/A	Samples	1 kHz	100 MHz
	Pre-FIR Samples	1 kHz	50 ^a MHz

a. The maximum sample rate depends on the selected filter when the data rate is Pre-FIR Samples. Refer to [“Input Mode” on page 212](#) for more information.

Clock Source

The clock signal for the N5102A module is provided in one of three ways through the following selections:

- Internal: generated internally in the interface module (requires an external reference)
- External: generated externally through the Ext Clock In connector
- Device: generated externally through the Device Interface connector

The clock source is selected using the N5102A module UI on the signal generator, as shown in [Figure 11-2](#).

Figure 11-2 Clock Source Selection

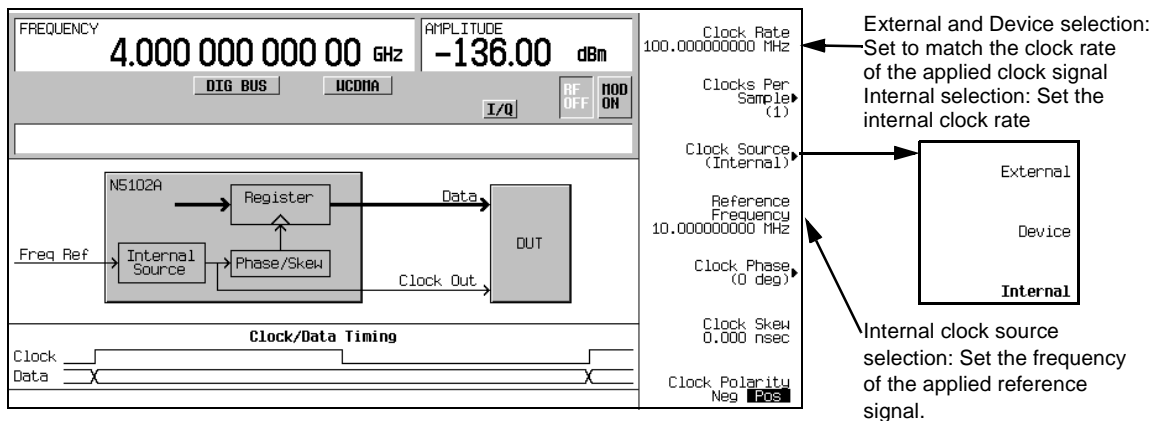

When you select a clock source, you must let the N5102A module know the frequency of the clock signal using the **Clock Rate** softkey. In the internal clock source mode, use this softkey to set the internal clock rate. For device and external clock sources, this softkey must reflect the frequency of the applied clock signal.

When the clock source is Internal, a frequency reference must be applied to the Freq Ref connector. The frequency of this applied signal needs to be specified using the **Reference Frequency** softkey, unless the current setting matches that of the applied signal.

The selected clock source provides the interface module output clock signal at the Clock Out and the Device Interface connectors.

Common Frequency Reference

The clocking flexibility of the digital signal interface module allows the setting of arbitrary clock rates for the device under test. In general, the clock rate inside the PSG will be different from the interface module clock rate, so the interface module performs a rate conversion. An important aspect of this conversion is to have accurate clock rate information to avoid losing data. The module relies on relative clock accuracy, instead of absolute accuracy, that must be ensured by using a single frequency reference for all clock rates involved in the test setup. This can be implemented in various ways (see the five drawings in [Figure 11-3 on page 203](#)), but whatever way it is implemented, the

clock inside the signal generator must have the same base frequency reference as the clock used by the device under test.

PSG Frequency Reference Connections

When a frequency reference is connected to the PSG, it is applied to one of two rear-panel connectors:

- 10 MHz IN
- BASEBAND GEN REF IN

The BASEBAND GEN REF IN connector will accept a frequency reference in the range of 1 to 100 MHz. If the external or device under test clock source cannot provide or accept a frequency reference, that clock signal can be applied to this connector and used as the frequency reference.

Whenever an external clock signal or frequency reference is connected to the BASEBAND GEN REF IN connector, its frequency needs to be entered into the current signal generator modulation format. For information on the BASEBAND GEN REF IN connector refer to [“5. BASEBAND GEN REF IN” on page 21](#). For information on the associated softkeys and fields for entering the frequency of the applied clock signal or frequency reference, refer to the *E8257D/67D PSG Signal Generators Key Reference*.

Figure 11-3 Frequency Reference Setup Diagrams for the N5102A Module Clock Signal

Internally Generated Clock

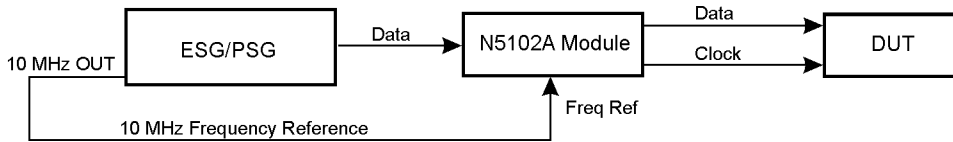

Device (DUT) Supplied Clock

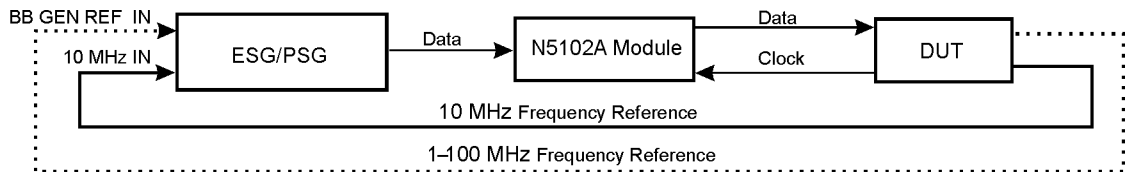
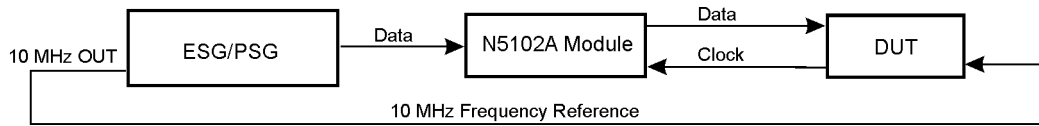

NOTE: Use only one of the two signal generator frequency reference inputs.

Externally Supplied Clock

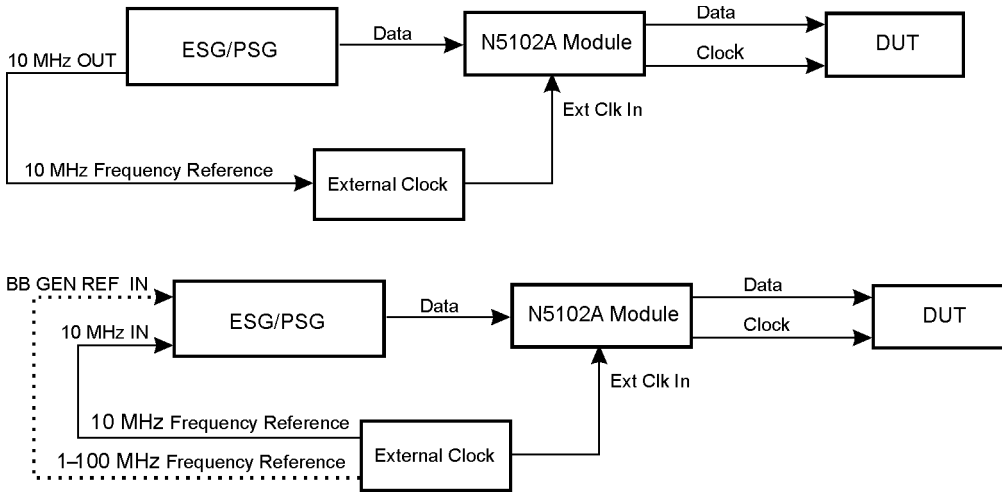

NOTE: Use only one of the two signal generator frequency reference inputs.

Clock Timing for Parallel Data

Some components require multiple clocks during a single sample period. (A sample period consists of an I and Q sample). For parallel data transmissions, you can select one, two, or four clocks per sample. For clocks per sample greater than one, the I and Q samples are held constant to accommodate the additional clock periods. This reduces the sample rate relative to the clock rate by a factor equal to the clocks per sample selection. For example, when four is selected, the sample rate is reduced by a factor of four (sample rate to clock rate ratio). [Figure 11-4](#) demonstrates the clock timing for each clocks per sample selection. For input mode, the clocks per sample setting is always one.

Figure 11-4

Clock Sample Timing for Parallel Port Configuration

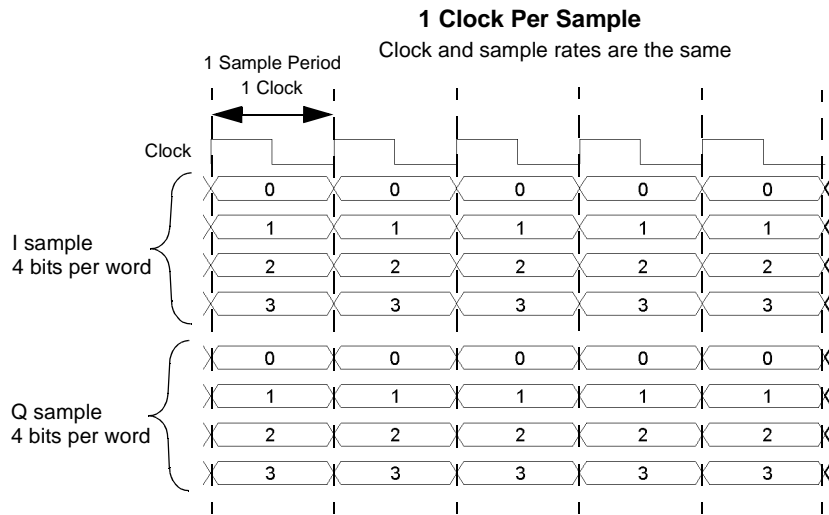

2 Clocks Per Sample

Sample rate decreases by a factor of two

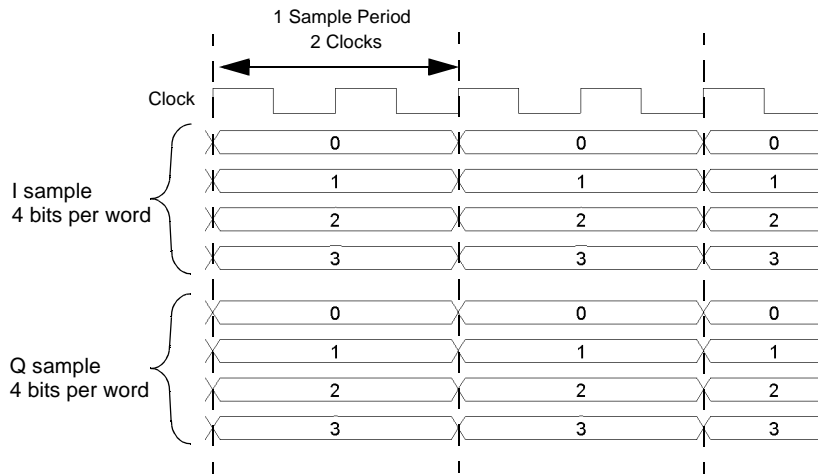

4 Clocks Per Sample

Sample rate decreases by a factor of four

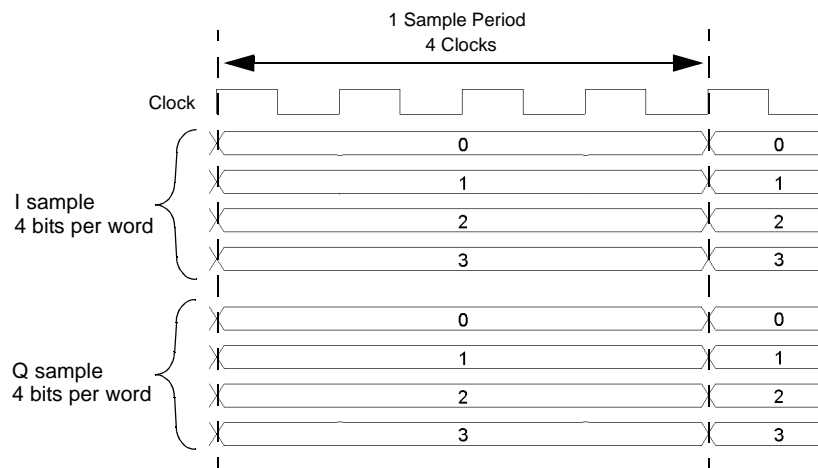

Clock Timing for Parallel Interleaved Data

The N5102A module provides the capability to interleave the digital I and Q samples. There are two choices for interleaving:

- IQ, where the I sample is transmitted first
- QI, where the Q sample is transmitted first

When parallel interleaved is selected, all samples are transmitted on the I data lines. This effectively transmits the same number of samples during a sample period on half the number of data lines as compared to non-interleaved samples. (A sample period consists of an I and Q sample.) Clocks per sample is still a valid parameter for parallel interleaved transmissions and creates a reduction in the sample rate relative to the clock rate. The clocks per sample selection is the ratio of the reduction. **Figure 11-5** shows each of the clocks per sample selections, for a parallel IQ interleaved port configuration, using a word sized of four bits and the clock timing relative to the I and Q samples. For a parallel QI interleaved port configuration, just reverse the I and Q sample positions. For input mode, the clocks per sample setting is always one.

Figure 11-5 Clock Timing for a Parallel IQ Interleaved Port Configuration

1 Clock Per Sample

The I sample is transmitted on one clock transition and the Q sample is transmitted on the other transition; the sample and clock rates are the same.

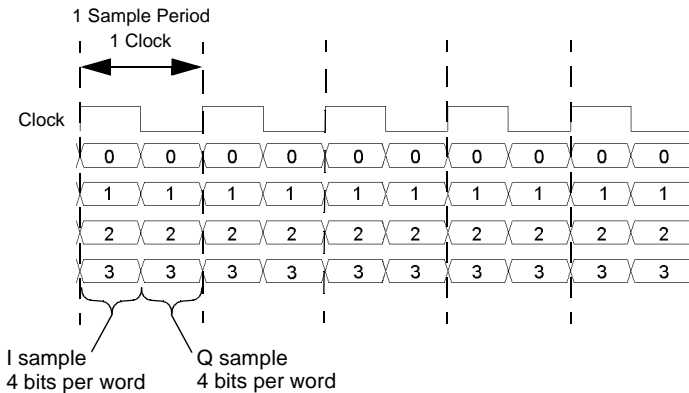

2 Clocks Per Sample

The I sample is transmitted for one clock period and the Q sample is transmitted during the second clock period; the sample rate decreases by a factor of two.

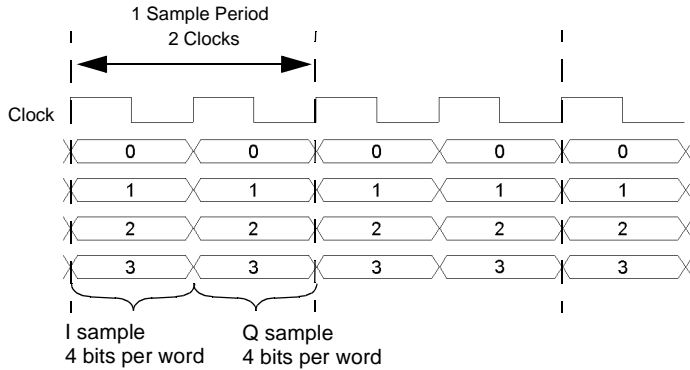

4 Clocks Per Sample

The I sample is transmitted for the first two clock periods and the Q sample is transmitted during the second two clock periods; the sample rate is decreased by a factor of four.

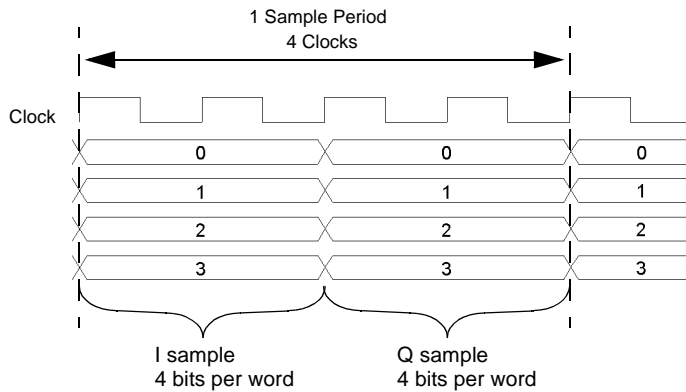

Clock Timing for Serial Data

Figure 11-6 shows the clock timing for a serial port configuration. Notice that the serial transmission includes frame pulses that mark the beginning of each sample while the clock delineates the beginning of each bit. For serial transmission, the clock and the bit rates are the same, but the sample rate varies depending on the number of bits per word that are entered using the **Word Size** softkey. The number of bits per word is the same as the number of bits per sample.

Figure 11-6 Clock Timing for a Serial Port Configuration

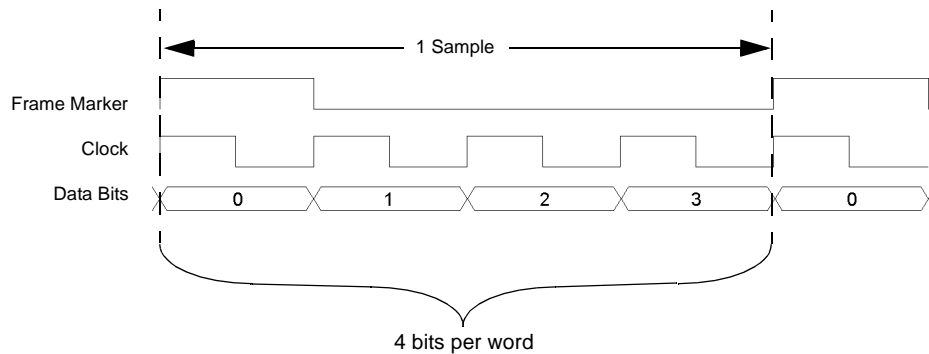

Clock Timing for Phase and Skew Adjustments

The N5102A module provides phase and skew adjustments for the clock relative to the data and can be used to align the clock with the valid portion of the data. The phase has a 90 degree resolution (0, 90, 180, and 270 degree selections) for clock rates from 10 to 200 MHz and a 180 degree resolution (0 and 180 degree selections) for clock rates below 10 MHz and greater than 200 MHz.

The skew is displayed in nanoseconds with a maximum range of ± 5 ns using a maximum of ± 127 discrete steps. Both the skew range and the number of discrete steps are variable with a dependency on the clock rate. The skew range decreases as the clock rate is increased and increases as the clock rate is decreased. The maximum skew range is reached at a clock rate of approximately 99 MHz and is maintained down to a clock rate of 25 MHz. For clock rates below 25 MHz, the skew adjustment is unavailable.

A discrete step is calculated using the following formula:

$$\frac{1}{256 \times \text{Clock Rate}}$$

The number of discrete steps required to reach the maximum skew range decreases at lower frequencies. For example, at a clock rate of 50 MHz, 127 steps would exceed the maximum skew range of ± 5 ns, so the actual number of discrete steps would be less than 127.

Figure 11-7 is an example of a phase and skew adjustment and shows the original clock and its phase position relative to the data after each adjustment. Notice that the skew adjustment adds to the phase setting.

Figure 11-7 Clock Phase and Skew Adjustments

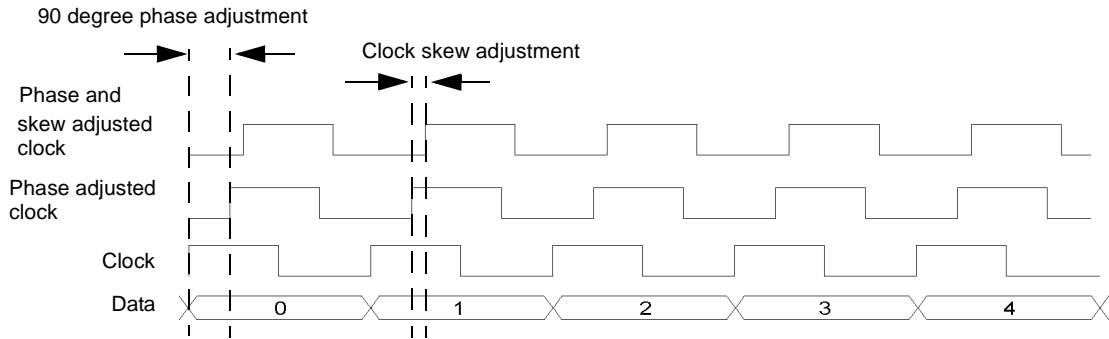

Connecting the Clock Source and the Device Under Test

As shown in [Figure 11-3 on page 203](#), there are numerous ways to provide a common frequency reference to the system components (PSG, N5102A module, and the device under test). [Figure 11-8](#) shows an example setup where the signal generator supplies the common frequency reference and the N5102A module provides the clock to the device.

See the *N5102A Digital Signal Interface Module Installation Guide* for detailed information on device interface connections.

CAUTION The Device Interface connector on the interface module communicates using high speed digital data. Use ESD precautions to eliminate potential damage when making connections.

NOTE You must disconnect the digital bus cable and the digital module while downloading firmware to the PSG.

Figure 11-8 Example Setup using the PSG 10 MHz Frequency Reference

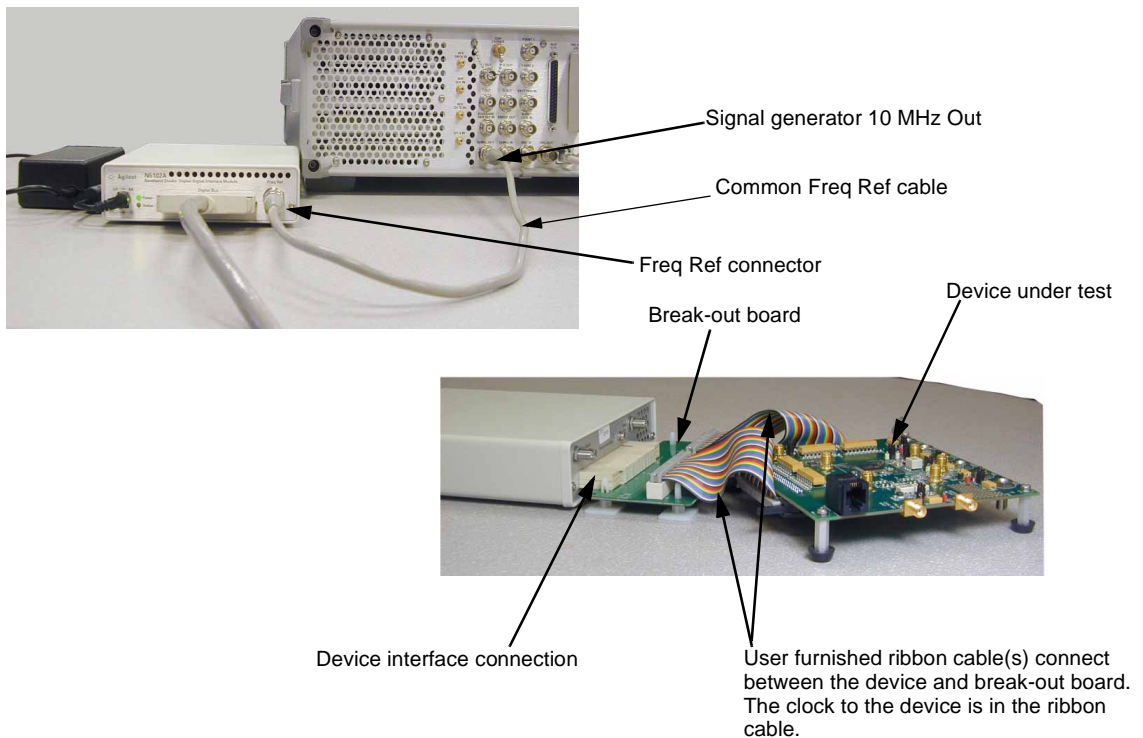

1. Refer to the five setup diagrams in [Figure 11-3 on page 203](#) and connect the frequency reference cable according to the clock source.
2. If an external clock source is used, connect the external clock signal to the Ext Clock In connector on the interface module.
3. Select the break-out board that has the output connector suited for the application. See the *N5102A Digital Signal Interface Module Installation Guide* for information on breakout boards.

NOTE If the Device Interface mating connector is used with the device under test, refer to [Figure 11-8](#) for the device interface connection and connect the device to the N5102A module. Then proceed to [“Operating the N5102A Module in Output Mode” on page 213](#) or [“Operating the N5102A Module in Input Mode” on page 222](#).

4. Refer to [Figure 11-8](#). Connect the breakout board to the N5102A module’s Device Interface connector.
5. Connect the device to the break-out board. See the *N5102A Digital Signal Interface Module Installation Guide* for information on breakout board connectivity.

Data Types

The following block diagram indicates where in the PSG signal generation process the data is injected for input mode or tapped for output mode.

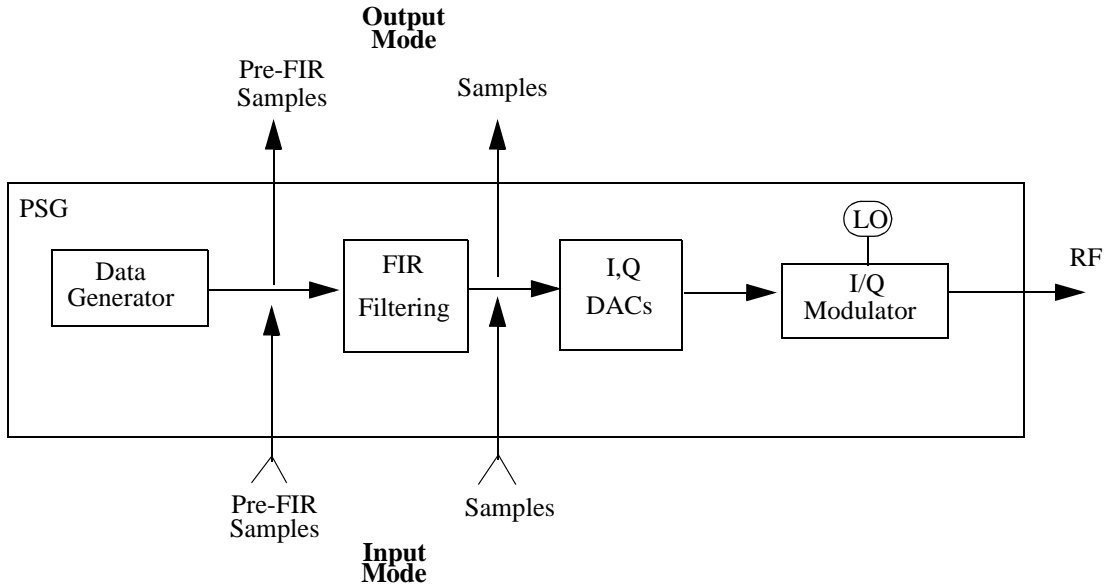

Output Mode

When using an ARB format, the data type is always Samples and no filtering is applied to the data samples. The samples are sent to the digital module at the ARB sample clock rate.

For real-time formats, choosing Samples as the data type will send filtered samples to the digital module at a rate between 50 MHz and 100 MHz. Selecting Pre-FIR Samples, sends unfiltered samples to the digital module at a rate equal to the sample rate of the current format.

Input Mode

When the data type is Samples, the data samples coming through the digital module are injected at a point that bypasses the filtering process.

If Pre-FIR Samples is selected, the data samples are injected before the filtering process. The maximum rate will be determined by the selected filter. Refer to [Table 11-7](#).

Table 11-7 Maximum Sample Rate for Selected Filter

Filter	Maximum Rate
Gaussian Nyquist Root Nyquist Rectangle Edge UN3/4 GSM Gaussian IS-95 IS 95 w/EQ	50 MHz
IS-95 Mod IS-95 Mod w/EQ	25 MHz
APCO 25 C4FM	12.5 MHz

The **Filter** softkey accesses a menu that enables you set the desired filtering parameters.

Operating the N5102A Module in Output Mode

This section shows how to set the parameters for the N5102A Option 003 module in output mode using the front-panel keys. Each procedure contains a figure that shows the softkey menu structure for the interface module function being performed.

Setting up the Signal Generator Baseband Data

The digital signal interface module receives data from a baseband source and outputs a digital IQ or digital IF signal relative to the selected logic type. Because the PSG provides the baseband data, the first procedure in operating the interface module is configuring the PSG using one of the real-time or ARB modulation formats, or playing back a stored file using the Dual ARB player. For information on setting up real-time or ARB waveforms, or to learn about using the Dual ARB player, refer to the appropriate chapter in this guide.

1. Preset the signal generator.
2. Select the modulation format (TDMA, Custom, and so forth) and set the desired parameters.
3. Turn-on the modulation format.

Accessing the N5102A Module User Interface

Press **Aux Fctn > N5102A Interface**.

This accesses the UI (first-level softkey menu shown in [Figure 11-9](#)) that is used to configure the digital signal interface module. Notice the graphic in the PSG display showing a setup where the N5102A module is generating its own internal clock signal. This graphic changes to reflect the current clock source selection.

Figure 11-9 First-Level Softkey Menu

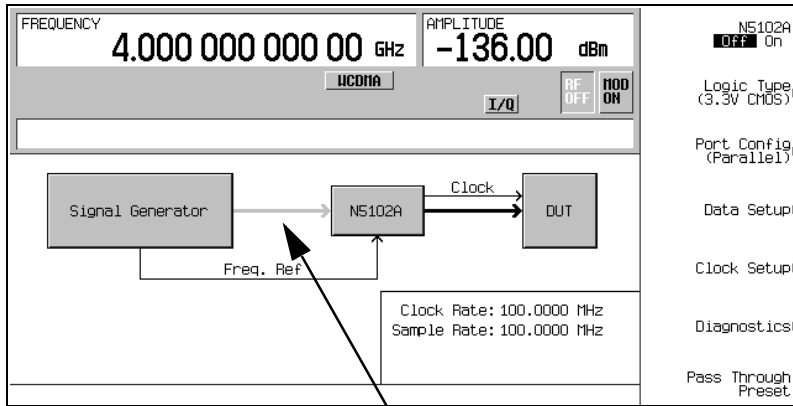

Line is grayed out until the N5102A module interface is turned on

Choosing the Logic Type and Port Configuration

Figure 11-10 Logic and Port Configuration Softkey Menus

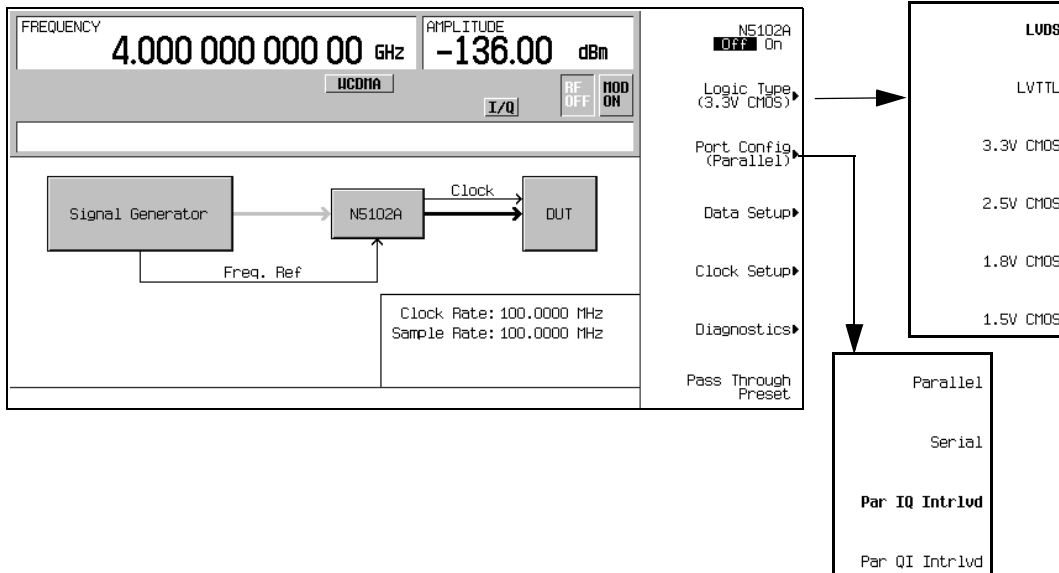

1. Refer to [Figure 11-10](#). Press the **Logic Type** softkey.
From this menu, choose a logic type.

CAUTION Changing the logic type can increase or decrease the signal voltage level going to the device under test. To avoid damaging the device and/or the N5102A module, ensure that both are capable of handling the voltage change.

2. Select the logic type required for the device being tested.

A caution message is displayed whenever a change is made to the logic types, and a softkey selection appears requesting confirmation.

3. Refer to [Figure 11-10](#). Press the **Port Configuration** softkey.

In this menu, select either a serial, parallel, or parallel interleaved data transmission.

NOTE Within the data and clock setup softkey menus, only softkeys that are relative to the current configuration are active. Softkeys that are grayed out are not available for the current setup. Refer to the help text to determine which parameter is causing the softkey to be unavailable. To get help information, press the **Help** hardkey, then press the unavailable softkey.

4. Select the port configuration for the device.

Selecting the Output Direction

Press **Data Setup > Direction Input Output** to **Output** and press **Return**.

NOTE If Option 003 is the only option installed, the direction softkey will be unavailable and the mode will always be output. With both Option 003 (output mode) and Option 004 (input mode) installed, the default direction is output.

Selecting the Data Parameters

This procedure guides you through the data setup menu. Softkeys that have self-explanatory names are generally not mentioned. For example, the **Word Size** softkey. For more information on all of the softkeys, refer to *E8257D/67D PSG Signal Generators Key Reference*.

1. Refer to [Figure 11-11](#). Press the **Data Setup** softkey.

Figure 11-11 Data Setup Menu Location

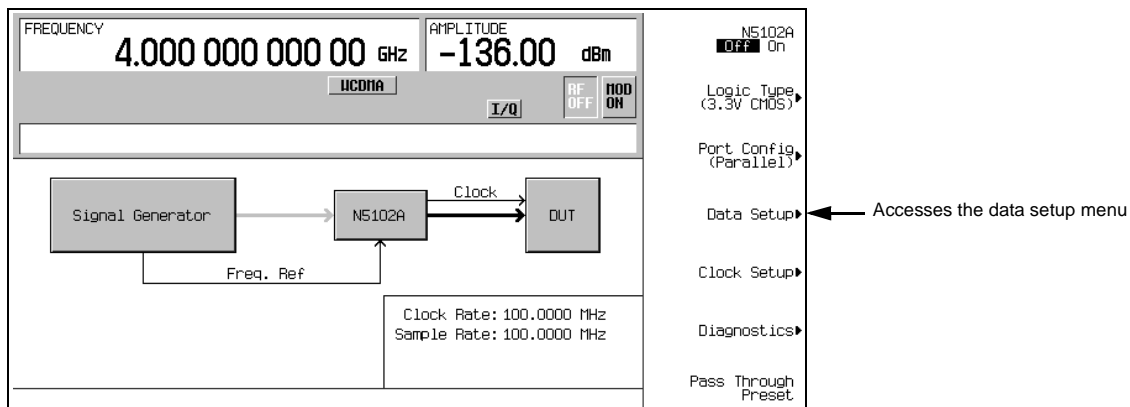

This softkey menu accesses the various parameters that govern the data received by the device under test. The status area of the display shows the number of data lines used for both I and Q along with the clock position relative to the data. When the port configuration is parallel or parallel interleaved, the number of data lines indicated is equivalent to the word (sample) size. When the port configuration is serial, the display will show that only one I and one Q data line is being used along with the frame marker that delineates the beginning of a sample. [Figure 11-12](#) shows the data setup menu structure.

Figure 11-12 Data Setup Softkey Menu with Parallel Port Configuration

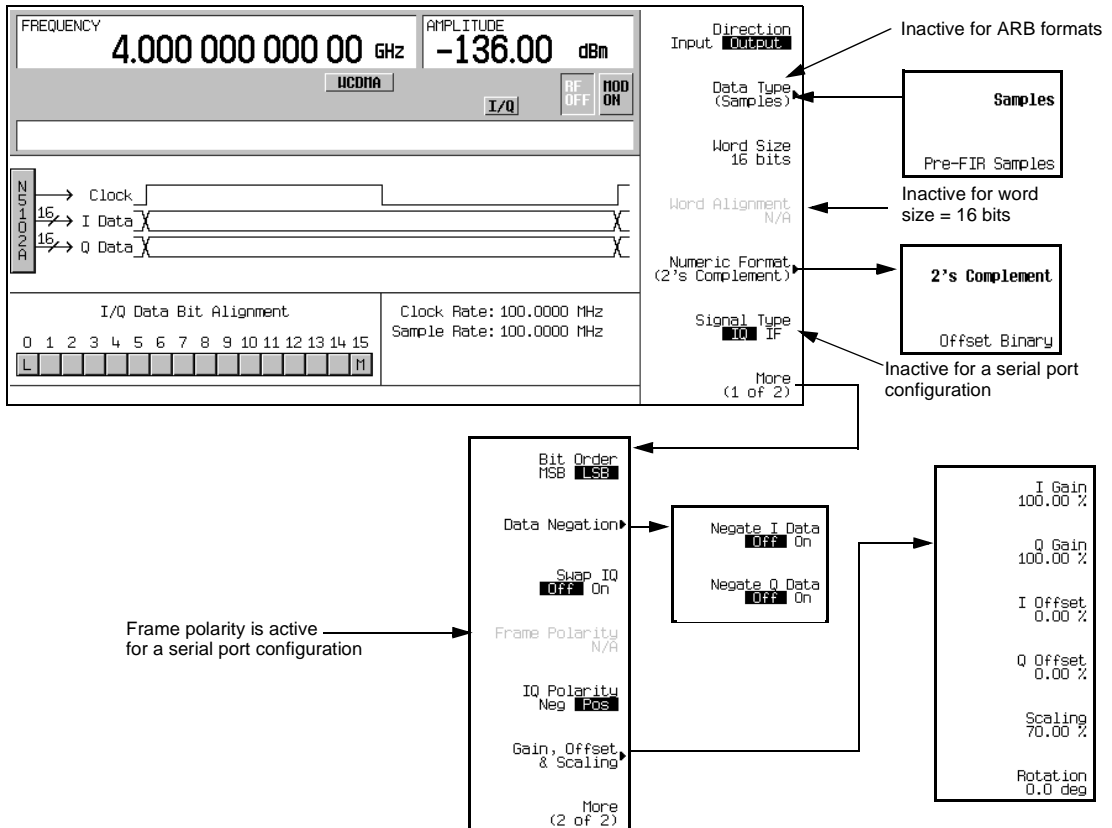

2. If a real-time modulation format is being used, press the **Data Type** softkey. (This softkey is inactive when an ARB modulation format is turned on.)

In this menu, select whether the real-time baseband data from the signal generator is either filtered (**Samples**) or unfiltered (**Pre-FIR Samples**). The selection depends on the test needs. The **Samples** selection provides FIR filtered baseband samples based on the communication standard of the active modulation format. This is the preset selection and the one most commonly used. However if the device being tested already incorporates FIR filters, the **Pre-FIR Samples** selection should be used to avoid double filtering.

3. Select the data type that is appropriate for the test.
4. Press the **Numeric Format** softkey.

From this menu, select how the binary values are represented. Selecting 2's complement allows both positive and negative data values. Use the **Offset Binary** selection when components cannot process negative values.

5. Select the numeric format required for the test.

6. Press the **More (1 of 2)** softkey.

From this softkey menu, select the bit order, swap I and Q, select the polarity of the transmitted data, and access menus that provide data negation, scaling, gain, offset, and IQ rotation adjustments.

7. Press the **Data Negation** softkey.

Negation differs from changing the I and Q polarity. Applied to a sample, negation changes the affected sample by expressing it in the two's complement form, multiplying it by negative one, and converting the sample back to the selected numeric format. This can be done for I samples, Q samples, or both.

The choice to use negation is dependent on the device being tested and how it needs to receive the data.

8. Press the **Gain, Offset & Scaling** softkey.

Use the softkeys in this menu for the following functions:

- reduce sample values for both I and Q using the **Scaling** softkey
- increase or decrease the sample values independently for I and Q using the **I Gain** and **Q Gain** softkeys
- compensate for or add a DC offset using the **I Offset** and **Q Offset** softkeys
- rotate the data on the IQ plane using the **Rotation** softkey

9. Make any required scaling, gain, offset, or rotation adjustments to properly test the device.

10. Press **Return > Return** to return to the first-level softkey menu.

Configuring the Clock Signal

1. Refer to [Figure 11-13](#). Press the **Clock Setup** softkey.

Figure 11-13 Clock Setup Menu Location

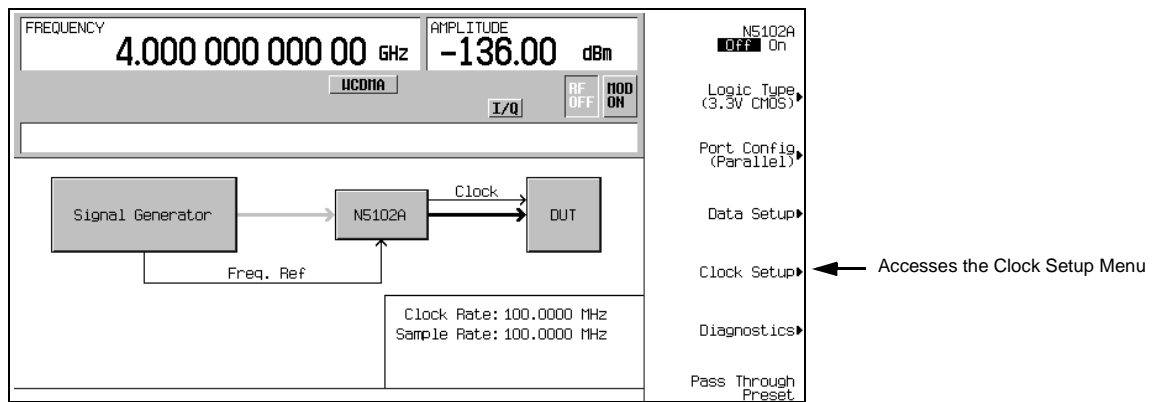

From this softkey menu, set all of the clock parameters that synchronize the clocks between the N5102A module and the PSG. You can also change the clock signal phase so the clock occurs during the valid portion of the data. Figure 11-14 shows the clock setup menu.

Figure 11-14 Clock Setup Softkey Menu for a Parallel Port Configuration

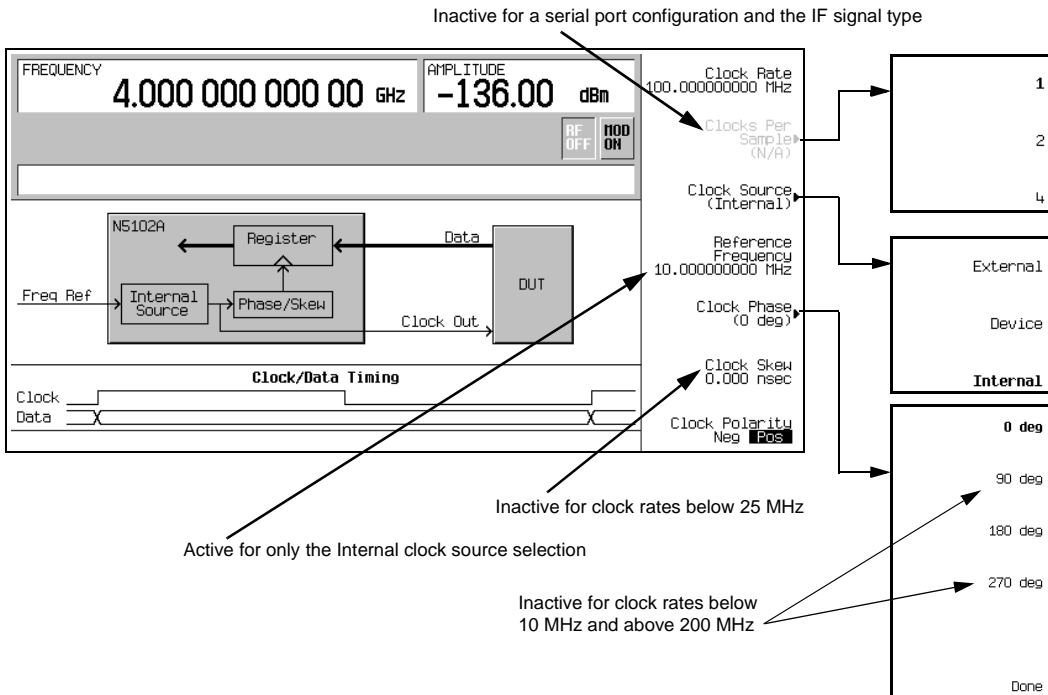

The top graphic on the display shows the current clock source that provides the output clock signal at the Clock Out and Device Interface connectors. The graphic changes to reflect the clock source selection discussed later in this procedure. The bottom graphic shows the clock position relative to the data. The displayed clock signal will change to reflect the following:

- clocks per sample selection
- clock phase choice
- clock skew adjustment
- clock polarity selection

If the device or external clock does not match the frequency, one of the following error messages will appear on the PSG:

805 Digital module output FIFO overflow error; There are more samples being produced than can be consumed at the current clock rate. Verify that the digital module clock is set up properly.

This error is reported when the output FIFO is overflowing in the digital module. This error can be generated if an external clock or its reference is not set up properly, or if the internal VCO is unlocked.

806 Digital module output FIFO underflow error; There are not enough samples being produced for the current clock rate. Verify that the digital module clock is set up properly.

This error is reported when the output FIFO is underflowing in the digital module. This error can be generated if an external clock or its reference is not set up properly, or if the internal VCO is unlocked.

2. If the port configuration is parallel or parallel interleaved, using an IQ signal type, press the **Clocks Per Sample** softkey.

Notice that multiple clocks per sample can be selected. Some DACs require the ability to clock multiple times for each sample; having a clocks per sample value greater than one reduces the sample rate by a factor equal to the selected number of clocks per sample. The sample rate is viewed on the first-level and Data Setup softkey menus.

3. Select the clocks per sample value to fit the test.
4. Press the **Clock Source** softkey.

From this menu, select the clock signal source. With each selection, the clock routing display in the signal generator clock setup menu will change to reflect the current clock source. This will be indicated by a change in the graphic.

5. Select the clock source.

If External or Device is Selected

Press the **Clock Rate** softkey and enter the clock rate of the externally applied clock signal.

NOTE The clock phase and clock skew may need to be adjusted each time the clock rate setting is changed. Refer to [“Clock Timing for Phase and Skew Adjustments” on page 209](#).

For the **External** selection, the signal is supplied by an external clock source and applied to the Ext Clock In connector. For the **Device** selection, the clock signal is supplied through the Device Interface connector, generally by the device under test.

If Internal is Selected

Using an external frequency reference, the N5102A module generates its own internal clock signal. The reference frequency signal must be applied to the Freq Ref connector on the digital module.

- a. Press the **Reference Frequency** softkey and enter the frequency of the externally applied frequency reference.
- b. Press the **Clock Rate** softkey and enter the appropriate clock rate.

[Table 11-8](#) provides a quick view of the settings and connections associated with each clock source selection.

Table 11-8 Clock Source Settings and Connectors

Clock Source	Softkeys		N5102A Module Connection		
	Reference Frequency	Clock Rate ^a	Freq Ref	Ext Clock In	Device Interface
External		•		•	
Device		•			•
Internal ^b	•	•	•		

a. For the Internal selection, this sets the internal clock rate. For the External and Device selections, this tells the interface module the rate of the applied clock signal.

b. There should be no clock signal applied to the Ext Clock In connector.

6. Press the **Clock Phase** softkey.

From the menu that appears, you can adjust the phase of the clock relative to the data in 90 degree increments. The selections provide a coarse adjustment for positioning the clock on the valid portion of the data. Selecting 180 degrees is the same as selecting a negative clock polarity.

The 90 degree and 270 degree selections are not available when the clock rate is set below 10 MHz or above 200 MHz. If 90 degrees or 270 degrees is selected when the clock rate is set below 10 MHz or above 200 MHz, the phase will change to 0 degrees or 180 degrees, respectively.

NOTE The clock phase and clock skew may need to be adjusted any time the clock rate setting is changed. Refer to [“Clock Timing for Phase and Skew Adjustments” on page 209](#).

7. Enter the required phase adjustment.
8. Press the **Return** softkey to return to the clock setup menu.
9. Press the **Clock Skew** softkey.

This provides a fine adjustment for the clock relative to its current phase position. The skew is a phase adjustment using increments of time. This enables greater skew adjustment capability at higher clock rates. For clock rates below 25 MHz, this softkey is inactive.

The skew has discrete values with a range that is dependent on the clock rate. Refer to [“Clock Timing for Phase and Skew Adjustments” on page 209](#) for more information on skew settings.

10. Enter the skew adjustment that best positions the clock with the valid portion of the data.
11. Press the **Clock Polarity Neg Pos** softkey to Neg.

This shifts the clock signal 180 degrees, so that the data starts during the negative clock transition. This has the same affect as selecting the 180 degree phase adjustment.

12. Make the clock polarity selection that is required for the device being tested.
13. Press the **Return** hardkey to return to the first-level softkey menu.

The clock source selection is also reflected in the first-level softkey menu graphic. For example, if the device is the new clock source, the graphic will show that the frequency reference is now connected to the DUT and the DUT has an input clock line going to the N5102A module.

Generating Digital Data

Press the **N5102A Off On** softkey to On.

Digital data is now being transferred through the N5102A module to the device. The green status light should be blinking. This indicates that the data lines are active. If the status light is solidly illuminated (not blinking), all the data lines are inactive. The status light comes on and stays on (blinking or solid) after the first time the N5102A module is turned on (**N5102A Off On** to On). The status light will stay on until the module is disconnected from its power supply.

The interface module can only be turned on while a modulation format is active. If the modulation format is turned off while the module is on, the module will turn off and an error will be reported.

NOTE If changes are made to the baseband data parameters, it is recommended that you first disable the digital output (**N5102A Off On** softkey to Off) to avoid exposing your device and the N5102A module to the signal variations that may occur during the parameter changes.

Operating the N5102A Module in Input Mode

This section shows how to set the parameters for the N5102A Option 004 module using the signal generator UI in the input direction. Each procedure contains a figure that shows the softkey menu structure for the interface module function being performed.

Refer to [“Connecting the Clock Source and the Device Under Test” on page 210](#) and configure the test setup.

Accessing the N5102A Module User Interface

All parameters for the N5102A module are set with softkeys on the PSG signal generator.

Press **Aux Fctn > N5102A Interface**.

This accesses the UI (first-level softkey menu shown in [Figure 11-15](#)) that is used to configure the digital signal interface module. Notice the graphic, in the PSG display, showing a setup where the N5102A module is generating its own internal clock signal. This graphic changes to reflect the current clock source selection.

Figure 11-15 First-Level Softkey Menu

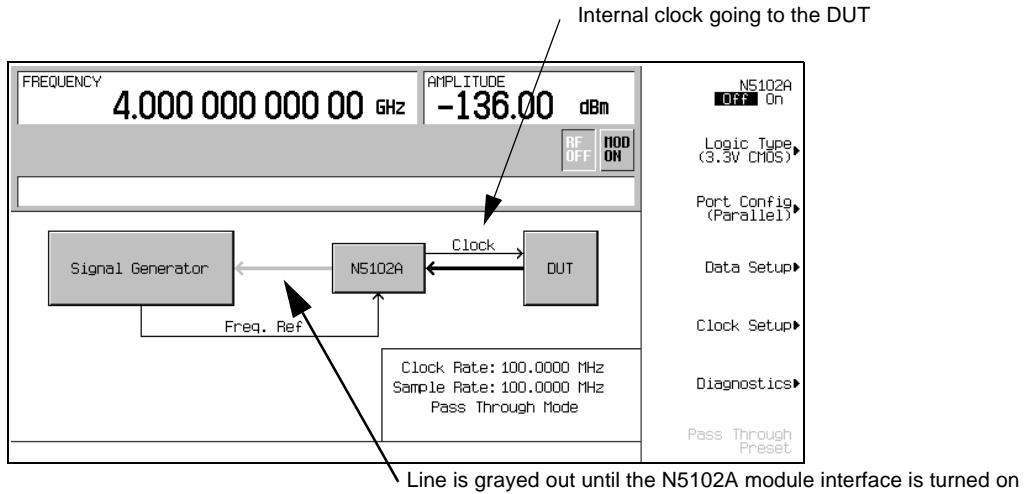

Selecting the Input Direction

If both Option 003 (output mode) and Option 004 (input mode) are installed, you must select the input direction.

Press **Data Setup > Direction Input Output** to Input and press **Return**.

NOTE If only Option 004 is installed, the direction softkey will be unavailable and the mode will always be input.

Choosing the Logic Type and Port Configuration

Figure 11-16 Logic and Port Configuration Softkey Menus

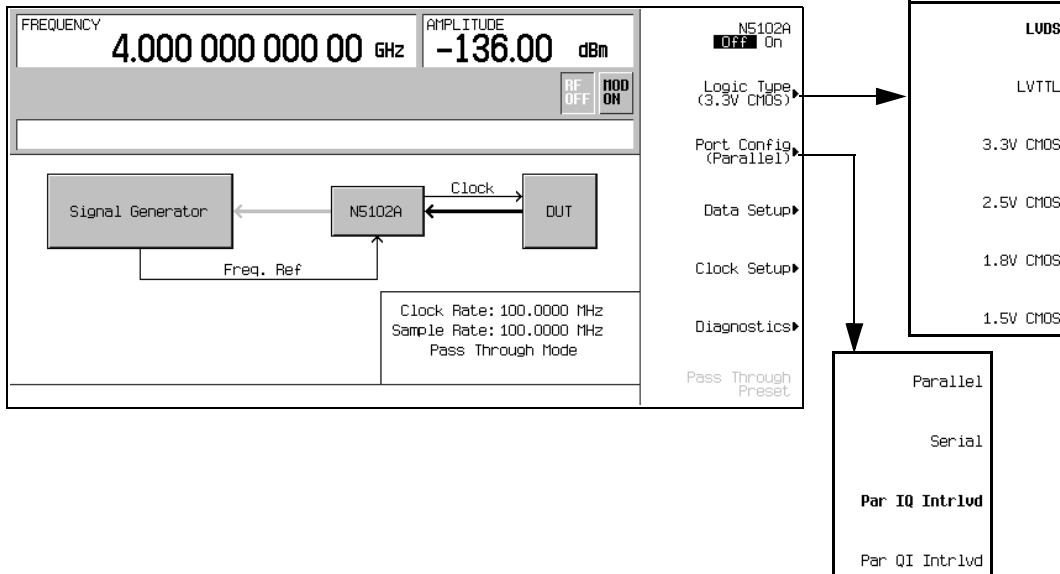

1. Refer to [Figure 11-16](#). Press the **Logic Type** softkey.
From this menu, choose a logic type.

CAUTION Changing the logic type can increase or decrease the signal voltage level. To avoid damaging the device and/or the N5102A module, ensure that both are capable of handling the voltage change.

2. Select the logic type required for the device being tested.
A caution message is displayed whenever a change is made to the logic types, and a softkey selection appears asking for confirmation.
3. Refer to [Figure 11-16](#). Press the **Port Configuration** softkey.
In this menu, select either a serial, parallel, or parallel interleaved data transmission.

NOTE Within the data and clock setup softkey menus, only softkeys that are relative to the current configuration are active. Softkeys that are grayed out are not available for the current setup. Refer to the help text to determine which parameter is causing the softkey to be unavailable. To get help information, press the **Help** hardkey, then press the unavailable softkey.

4. Select the port configuration for the device being tested.

Configuring the Clock Signal

1. Press the Clock Setup softkey, as shown in [Figure 11-17](#).

Figure 11-17 Clock Setup Menu Location

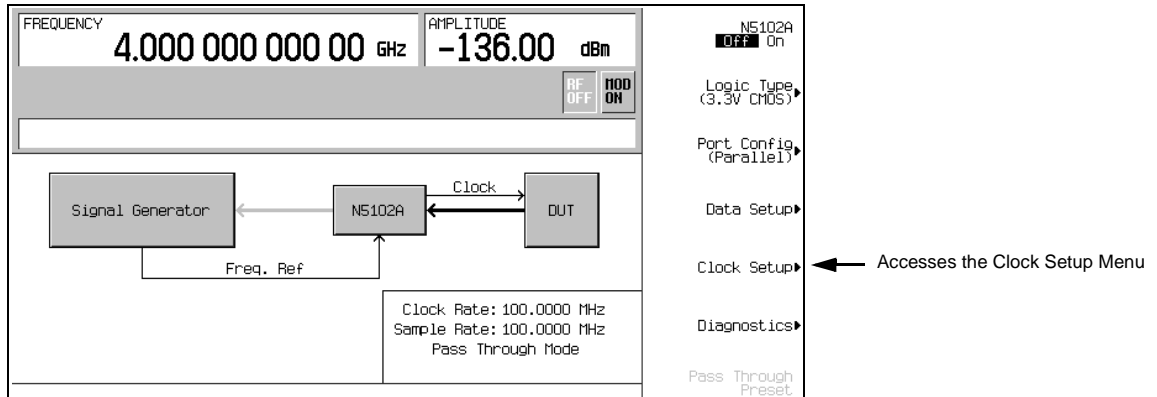

From this softkey menu, set all of the clock parameters that synchronize the data between the N5102A module and the device. From this menu, the clock signal phase can be changed so the clock occurs during the valid portion of the data. [Figure 11-18](#) shows the clock setup menu.

If the device or external clock does not match the frequency, one of the following error messages will appear on the PSG:

803 Digital module input FIFO overflow error; There are more samples being produced than can be consumed at the current clock rate. Verify that the digital module clock is set up properly.

This error is reported when the digital module clock setup is not synchronized with the rate the samples are entering the digital module. Verify that the input clock rate matches the specified clock rate under the clock setup menu.

804 Digital module input FIFO underflow error; There are not enough samples being produced for the current clock rate. Verify that the digital module clock is set up properly.

This error is reported when the digital module clock setup is not synchronized with the rate the samples are entering the digital module. Verify that the input clock rate matches the specified clock rate under the clock setup menu.

Figure 11-18 Clock Setup Softkey Menu for a Parallel Port Configuration

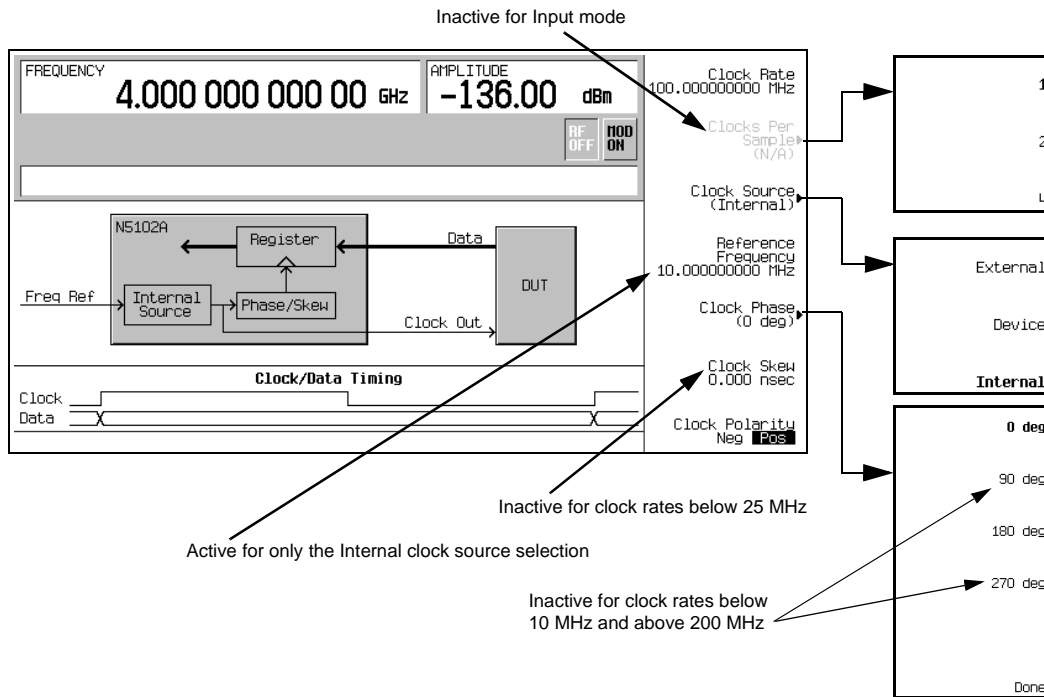

The top graphic on the display shows the current clock source that provides the output clock signal at the Clock Out and Device Interface connectors. The graphic changes to reflect the clock source selection discussed later in this procedure. The bottom graphic shows the clock edges relative to the data. The displayed clock signal will change to reflect the following:

- clock phase choice
- clock skew adjustment
- clock polarity selection

2. Press the **Clock Source** softkey.

From this menu, select the clock signal source. With each selection, the clock routing display in the signal generator clock setup menu will change to reflect the current clock source. This will be indicated by a change in the graphic.

3. Select the clock source.

If External or Device is Selected

Press the **Clock Rate** softkey and enter the clock rate of the externally applied clock signal.

NOTE The clock phase and clock skew may need to be adjusted any time the clock rate setting is changed. Refer to [“Clock Timing for Phase and Skew Adjustments” on page 209.](#)

For the **External** selection, the signal is supplied by an external clock source and applied to the Ext Clock In connector. For the **Device** selection, the clock signal is supplied through the Device Interface connector, generally by the device being tested.

If Internal is Selected

Using an external frequency reference, the N5102A module generates its own internal clock signal. The reference frequency signal must be applied to the Freq Ref connector on the digital module.

- a. Press the **Reference Frequency** softkey and enter the frequency of the externally applied frequency reference.
- b. Press the **Clock Rate** softkey and enter the appropriate clock rate.

Table 11-9 provides a quick view of the settings and connections associated with each clock source selection.

Table 11-9 Clock Source Settings and Connectors

Clock Source	Softkeys		N5102A Module Connection		
	Reference Frequency	Clock Rate ^a	Freq Ref	Ext Clock In	Device Interface
External		•		•	
Device		•			•
Internal ^b	•	•	•		

a. For the Internal selection, this sets the internal clock rate. For the External and Device selections, this tells the interface module the rate of the applied clock signal.

b. There should be no clock signal applied to the Ext Clock In connector when Internal is being used.

4. Press the **Clock Phase** softkey.

From the menu that appears, the phase of the clock relative to the data can be changed in 90 degree increments. The selections provide a coarse adjustment for positioning the clock on the valid portion of the data. Selecting 180 degrees is the same as selecting a negative clock polarity.

The 90 degree and 270 degree selections are not available when the clock rate is set below 10 MHz or above 200 MHz. If 90 degrees or 270 degrees is selected when the clock rate is set below 10 MHz or above 200 MHz, the phase will change to 0 degrees or 180 degrees, respectively.

NOTE The clock phase and clock skew may need to be adjusted any time the clock rate setting is changed. Refer to [“Clock Timing for Phase and Skew Adjustments” on page 209](#).

5. Enter the required phase adjustment.
6. Press the **Return** softkey to return to the clock setup menu.
7. Press the **Clock Skew** softkey.

This provides a fine adjustment for the clock relative to its current phase position. The skew is a phase adjustment using increments of time. This enables greater skew adjustment capability at higher clock rates. For clock rates below 25 MHz, this softkey is inactive.

The skew has discrete values with a range that is dependent on the clock rate. Refer to “[Clock Timing for Phase and Skew Adjustments](#)” on page 209 for more information on skew settings.

8. Enter the skew adjustment that best positions the clock with the valid portion of the data.
9. Press the **Clock Polarity Neg Pos** softkey to Neg.

This shifts the clock signal 180 degrees, so that the data starts during the negative clock transition. This has the same affect as selecting the 180 degree phase adjustment.

10. Make the clock polarity selection that is required for the device being tested.
11. Press the **Return** hardkey to return to the first-level softkey menu.

The clock source selection is also reflected in the first-level softkey menu graphic. For example, if the device is the new clock source, you will see that the frequency reference is now connected to the DUT and the DUT has an input clock line going to the N5102A module.

Selecting the Data Parameters

This procedure guides you through the data setup menu. Softkeys that have self-explanatory names (for example, the **Word Size** softkey) are generally not mentioned. For more information on all of the softkeys, refer to the *E8257D/67D PSG Signal Generators Key Reference*.

1. Refer to [Figure 11-19](#). Press the **Data Setup** softkey.

Figure 11-19 Data Setup Menu Location

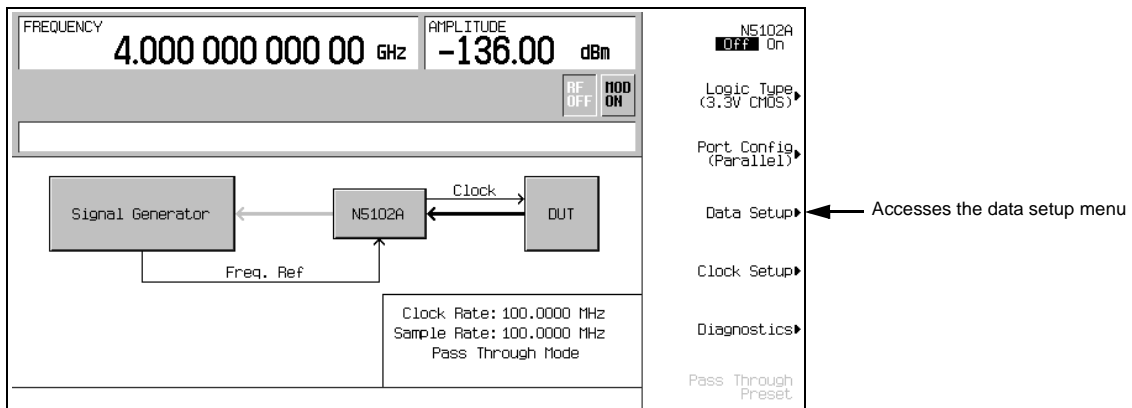

This softkey menu accesses the various parameters that govern the data received by the PSG. The status area of the display shows the number of data lines used for both I and Q along with the clock position relative to the data. [Figure 11-20](#) shows the data setup menu structure.

Figure 11-20 Data Setup Softkey Menu with Parallel Port Configuration

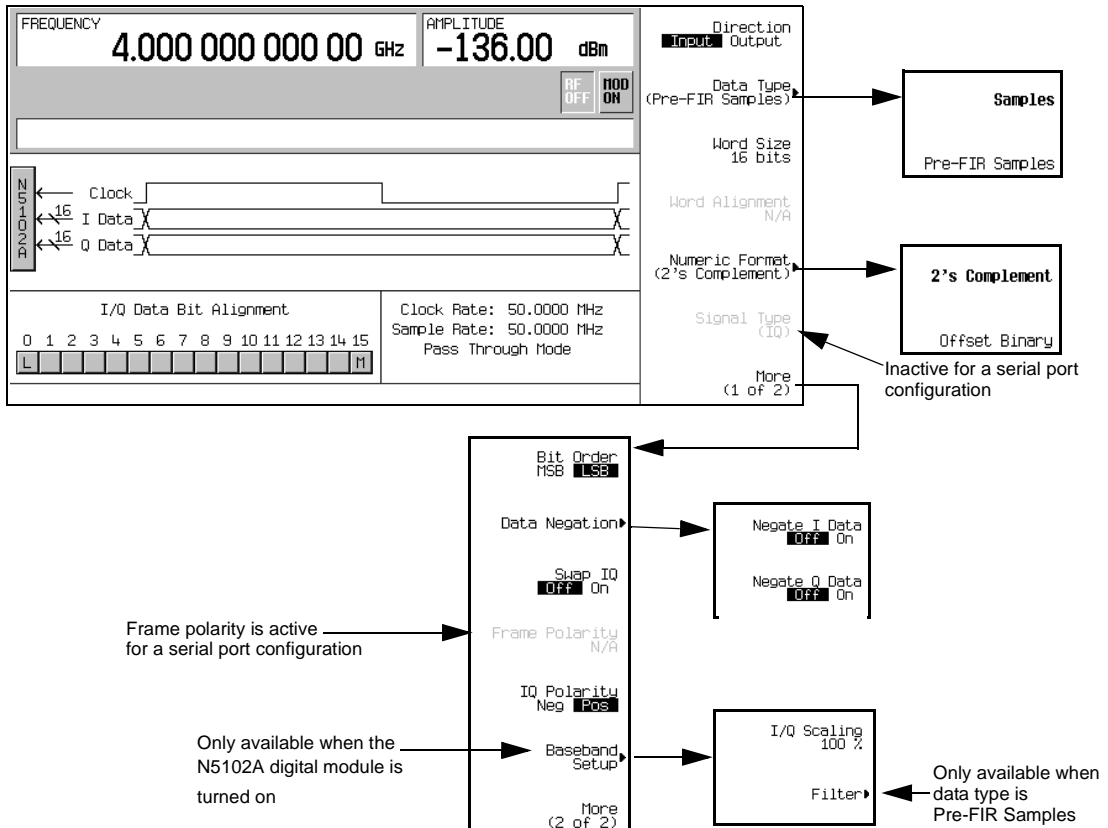

2. Press the **Data Type** softkey.

In this menu, select the data type to be either filtered (**Samples**) or unfiltered (**Pre-FIR Samples**). The selection is dependent on the test needs and the device under test. However if the device being tested already incorporates FIR filters, the **Pre-FIR Samples** selection should be used to avoid double filtering. Refer to [“Data Types” on page 212](#), for more information.

3. Select the data type that is appropriate for the test needs.

4. Press the **Numeric Format** softkey.

From this menu, select how the binary values are represented. Selecting 2's complement allows both positive and negative data values. Use the Offset Binary selection when components cannot process negative values.

5. Select the numeric format required for the test.

6. Press the **More (1 of 2)** softkey.

From this softkey menu, select the bit order, swap I and Q, the polarity of the data, and access menus that provides data negation, scaling, and filtering parameters.

7. Press the **Data Negation** softkey.

Negation differs from changing the I and Q polarity. Applied to a sample, negation changes the affected sample by expressing it in the two's complement form, multiplying it by negative one, and converting the sample back to the selected numeric format. This can be done for I samples, Q samples, or both.

The choice to use negation is dependent on the device being tested.

8. To access I/Q scaling and filter parameters, press **Return > N5102A Off On** to On. This will invoke the real time Custom format in the PSG baseband generator. This is needed to set the filter parameters when Pre-FIR Samples is selected as the data type.

9. Press the **Baseband Setup** softkey.

Use this softkey menu to adjust the I/Q scaling and access filter parameters. If the selected data type is Samples, the **Filter** softkey is grayed out (inactive).

Digital Data

If the N5102A digital module is not on, press **Return > Return > N5102A Off On** to On.

Digital data is now being transferred through the N5102A module to the PSG. The green status light should be blinking. This indicates that the data lines are active. If the status light is solidly illuminated (not blinking), all the data lines are inactive. The status light comes on and stays on (blinking or solid) after the first time the N5102A module is turned on (**N5102A Off On** softkey to On). The status light will stay on until the module is disconnected from its power supply.

NOTE If changes are made to the baseband data parameters, it is recommended that you first disable the digital output (**N5102A Off On** softkey to Off) to avoid exposing the device and the N5102A module to the signal variations that may occur during the parameter changes.

Millimeter-Wave Source Modules

You can extend the signal generator's RF frequency using an Agilent 8355x series millimeter-wave source module or any other external source module. The output frequency range depends on the frequency range of the mm-wave source module. This section contains the following procedures:

- [Using Agilent Millimeter-Wave Source Modules](#)
- [Using Other Source Modules](#)

Using Agilent Millimeter-Wave Source Modules

The Agilent 8355x series millimeter-wave source module connects to the signal generator's rear panel SOURCE MODULE INTERFACE connector and allows for direct communication between the instruments as well as providing for automatic leveling control of the source module. If you want to use an 8355x series source module without the automatic leveling or multiplier selection features, then refer to the section [“Using Other Source Modules”](#) on page 234.

The following is a list of equipment required for extending the frequency range of the signal generator:

- Agilent 8355x series millimeter-wave source module
- Agilent 8349B microwave amplifier (required only for the E8257D PSG without Option 1EA)
- RF output cables and adapters as required

NOTE Maximum insertion loss for cables and adapters connected to the E8267D PSG or E8257D PSG with Option 1EA should be less than 1.5 dB. This will ensure maximum power from the external source module.

Setting Up the External Source Module

CAUTION To prevent damage to the signal generator, turn off the line power to the signal generator before connecting the source module interface cable to the rear panel SOURCE MODULE INTERFACE connector.

1. Turn off the signal generator's line power.
2. Connect the equipment as shown.
 - E8257D PSG *without* Option 1EA uses the setup in [Figure 11-21](#).
 - E8257D PSG with Option 1EA or E8267D PSG uses the setup in [Figure 11-22](#).

Figure 11-21 Setup for E8257D PSG *without* Option 1EA

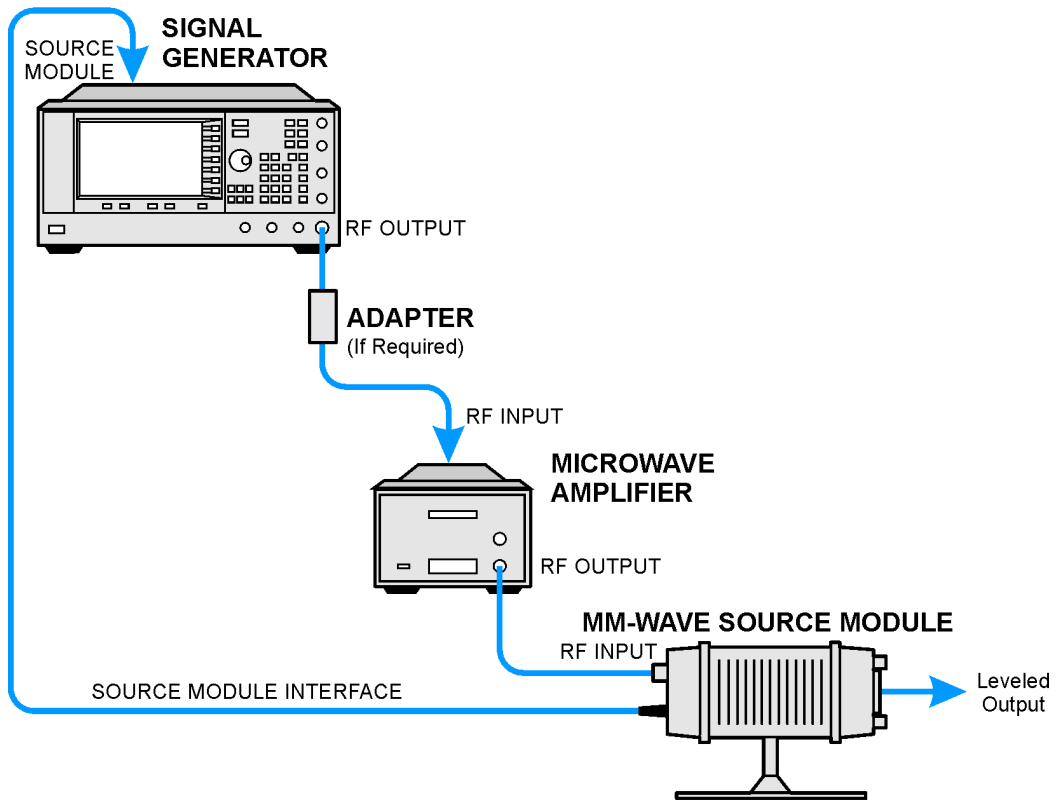
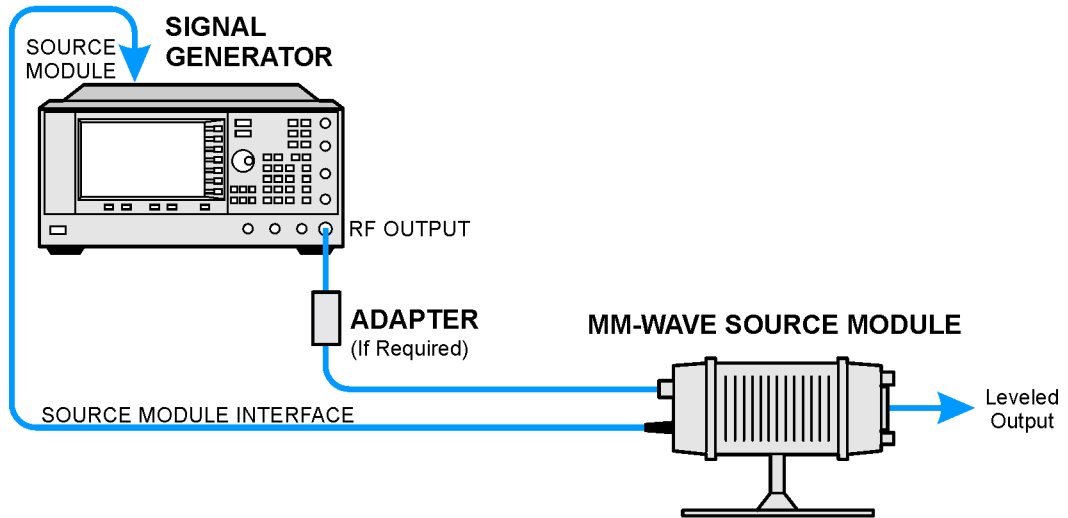

Figure 11-22 Setup for E8267D PSG and E8257D PSG with Option 1EA



Configuring the Signal Generator

1. Turn on the signal generator's line power.

NOTE Refer to the mm-wave source module specifications for the specific frequency and amplitude ranges.

2. Press **Frequency > (3 of 3) > Source Module**, toggle the **Agilent 8355x Source Module Off On** softkey to **On**. The signal generator will:
 - recognize the Agilent mm-wave source module,
 - switch the leveling mode to external/source module (power is leveled at the mm-wave source module output),
 - set the mm-wave source module frequency and amplitude to the source module's preset values, and
 - display the RF output frequency and amplitude values available at the mm-wave source module output when enabled

When the 8355x series mm-wave source is enable via the front panel Agilent 8355x Source Module Off On softkey, the MMOD indicator in the FREQUENCY area and the MM indicator in the AMPLITUDE area will appear on the signal generator's display.

3. If the RF OFF annunciator is displayed, press **RF On/Off**.

Leveled power should be available at the output of the millimeter-wave source module.

To obtain flatness-corrected power, refer to [“Creating and Applying User Flatness Correction” on page 119](#).

Using Other Source Modules

Use the following procedure to extend the frequency range of the PSG with any external source module, or to use the Agilent 8355x series millimeter-wave source module's without automatic leveling. The following is a list of equipment required for extending the frequency range of the signal generator:

- external millimeter-wave source module
- Agilent 8349B or other microwave amplifier (required only for the E8257D PSG without Option 1EA)
- RF output cables and adapters as required

Setting Up the External Source Module

1. Turn off the signal generator's line power.
2. Connect the equipment as shown.
 - E8257D PSG *without* Option 1EA uses the setup in [Figure 11-23](#).
 - E8257D PSG with Option 1EA or E8267D PSG uses the setup in [Figure 11-24](#).

Figure 11-23 Setup for E8257D PSG *without* Option 1EA

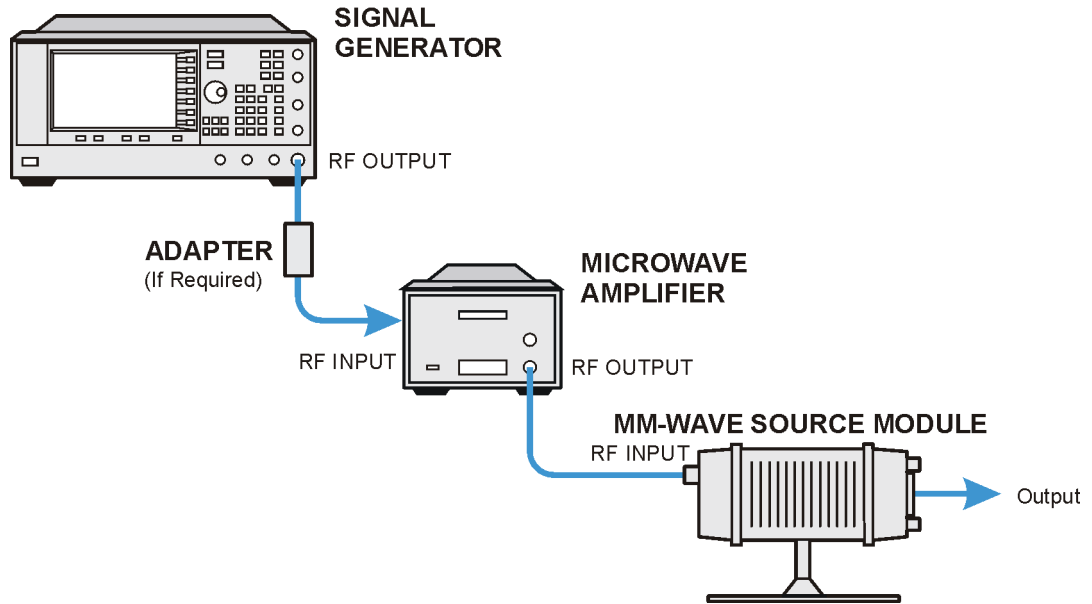
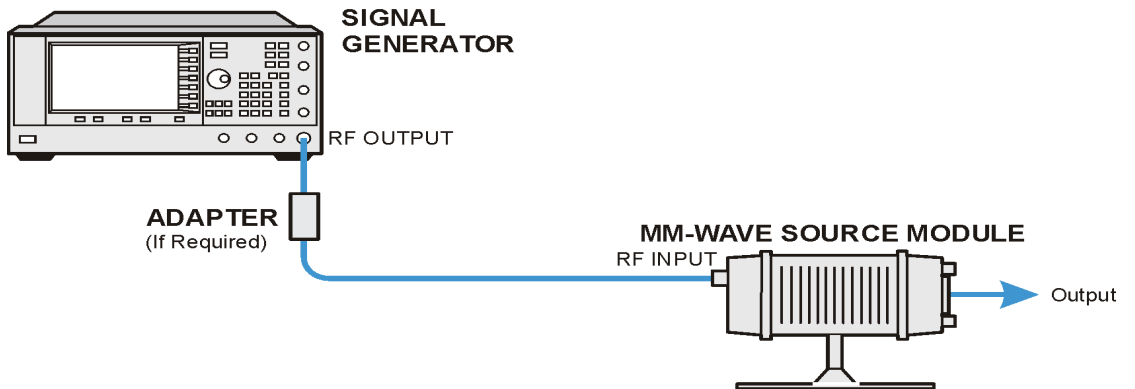

Figure 11-24 Setup for E8267D PSG and E8257D PSG with Option 1EA



Configuring the Signal Generator

The following procedure configures a PSG for use with any external source module that has a WR (waveguide rectangular) frequency range of 90-140 GHz. You can modify the frequency range to match your source module.

1. Turn on the signal generator's line power.

NOTE *Automatic leveling at the source module output is not available with the OEM Source Module selection.*

2. Press **Frequency > (3 of 3) > Source Module**. Toggle the **Agilent 8355x Source Module Off On** softkey to **Off**.
3. Toggle the **OEM Source Off On** softkey to **On**.
4. Press **OEM Source Module Config > Standard WR Freq Bands > WR8 90-140GHz**.

The selections in the Standard WR Freq Bands menu are pre-defined frequency ranges and multipliers for the most common external source module frequency ranges. They are provided for setup convenience. If your source module has a frequency range not listed in the list of pre-defined setups, use the **Min Band Freq**, **Max Band Freq**, and **Freq Multiplier** softkeys to manually set the range and PSG frequency display multiplier. For more information on these manual settings, refer to the *E8257D/67D PSG Signal Generators Key Reference*.

5. If the **RF OFF** annunciator is displayed, press **RF On/Off**.

To obtain flatness-corrected power, refer to [“Creating and Applying User Flatness Correction” on page 119](#).

12 Troubleshooting

This chapter provides basic troubleshooting information for Agilent PSG signal generators. If you do not find a solution here, refer to the *E8257D/67D PSG Signal Generators Service Guide*.

NOTE If the signal generator displays an error, always read the error message text by pressing **Utility > Error Info**.

- “RF Output Power Problems” on page 237
- “No Modulation at the RF Output” on page 241
- “Sweep Problems” on page 242
- “Data Storage Problems” on page 243
- “Cannot Turn Off Help Mode” on page 244
- “Signal Generator Locks Up” on page 244
- “Error Messages” on page 245
- “Contacting Agilent Sales and Service Offices” on page 247
- “Returning a Signal Generator to Agilent Technologies” on page 247

RF Output Power Problems

Check the RF ON/OFF annunciator on the display. If it reads RF OFF, press **RF On/Off** to toggle the RF output on.

No RF Output Power when Playing a Waveform File

Preset the signal generator, then replay the waveform file.

If a header file is not specified for a waveform, the signal generator uses a default header file with unspecified settings. If you play a waveform file that has unspecified signal generator settings (settings not saved to the file header, see [page 82](#)), the signal generator will use the header file settings from the previously played file. If the previous header file had a marker routed to RF blanking, the RF output power will be blanked. Preset the signal generator to return the RF blanking marker function to its default state—off). Refer to the *E8257D/67D PSG Signal Generators Key Reference*, Marker section, for more information.

NOTE If the default marker file is used, ensure that the **Pulse/RF Blank** softkey is set to **None**. Markers may have been set to **Pulse/RF Blank** by a previous file header.

RF Output Power too Low

1. Look for an OFFS or REF indicator in the AMPLITUDE area of the display.

OFFS tells you that an amplitude offset has been set. An amplitude offset changes the value shown in the AMPLITUDE area of the display but does not affect the output power. The amplitude displayed is equal to the current power output by the signal generator hardware plus the value for the offset.

To eliminate the offset, press the following keys:

Amplitude > More (1 of 2) > Ampl Offset > 0 > dB.

REF tells you that the amplitude reference mode is activated. When this mode is on, the displayed amplitude value is *not* the output power level. It is the current power output by the signal generator hardware minus the reference value set by the **Ampl Ref Set** softkey.

To exit the reference mode, follow these steps:

- a. Press **Amplitude > More (1 of 2)**.
- b. Press **Ampl Ref Off On** until Off is highlighted.

You can then reset the output power to the desired level.

2. If you are using the signal generator with an external mixer, see [“Signal Loss While Working with a Mixer” on page 238](#).
3. If you are using the signal generator with a spectrum analyzer, see [“Signal Loss While Working with a Spectrum Analyzer” on page 240](#).

The Power Supply has Shut Down

If the power supply is not working, it requires repair or replacement. There is no user-replaceable power supply fuse. Refer to the *E8257D/67D PSG Signal Generators Service Guide* for instructions.

Signal Loss While Working with a Mixer

If you experience signal loss at the signal generator’s RF output during low-amplitude coupled operation with a mixer, you can solve the problem by adding attenuation and increasing the RF output amplitude of the signal generator.

[Figure 12-1](#) shows a hypothetical configuration in which the signal generator provides a low amplitude signal to a mixer.

Figure 12-1 Effects of Reverse Power on ALC

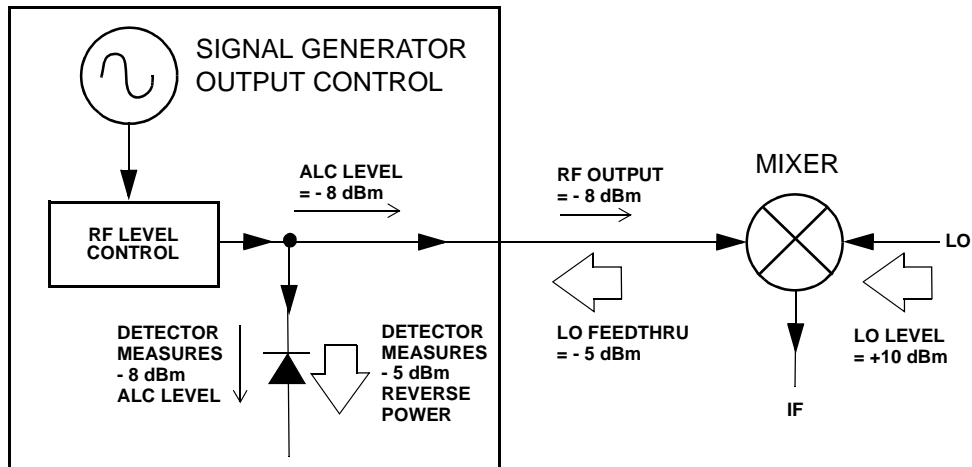

The internally leveled signal generator RF output (and ALC level) is -8 dBm. The mixer is driven with an LO of +10 dBm and has an LO-to-RF isolation of 15 dB. The resulting LO feedthrough of -5 dBm enters the signal generator's RF output connector and arrives at the internal detector.

Depending on frequency, it is possible for most of this LO feedthrough energy to enter the detector. Since the detector responds to its total input power regardless of frequency, this excess energy causes the ALC to reduce the RF output of the signal generator. In this example, the reverse power across the detector is actually greater than the ALC level, which may result in loss of signal at the RF output.

Figure 12-2 on page 240 shows a similar configuration with the addition of a 10 dB attenuator connected between the RF output of the signal generator and the input of the mixer. The signal generator's ALC level is increased to +2 dBm and transmitted through a 10 dB attenuator to achieve the required -8 dBm amplitude at the mixer input.

Figure 12-2 Reverse Power Solution

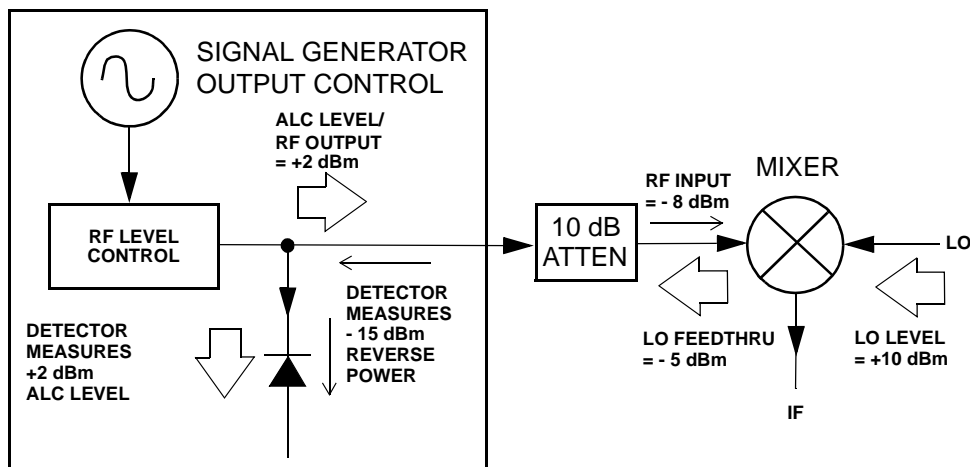

Compared to the original configuration, the ALC level is 10 dB higher while the attenuator reduces the LO feedthru (and the RF output of the signal generator) by 10 dB. Using the attenuated configuration, the detector is exposed to a +2 dBm desired signal versus the -15 dBm undesired LO feedthru. This 17 dB difference between desired and undesired energy results in a maximum 0.1 dB shift in the signal generator's RF output level.

Signal Loss While Working with a Spectrum Analyzer

The effects of reverse power can cause problems with the signal generator's RF output when the signal generator is used with a spectrum analyzer that does not have preselection capability.

Some spectrum analyzers have as much as +5 dBm LO feedthru at their RF input port at some frequencies. If the frequency difference between the LO feedthru and the RF carrier is less than the ALC bandwidth, the LO's reverse power can cause amplitude modulation of the signal generator's RF output. The rate of the undesired AM equals the difference in frequency between the spectrum analyzer's LO feedthru and the RF carrier of the signal generator.

Reverse power problems can be solved by using one of two unlevelled operating modes: ALC off or power search.

Setting ALC Off Mode

ALC off mode deactivates the automatic leveling circuitry prior to the signal generator's RF output. In this mode, a power meter is required to measure the output of the signal generator and assist in achieving the required output power at the point of detection.

Use the following steps to set the signal generator to the ALC off mode:

1. Preset the signal generator: press **Preset**.
2. Set the desired frequency: press **Frequency** and enter the desired frequency.
3. Set the desired amplitude: press **Amplitude** and enter the desired amplitude.

4. Turn the RF off: set **RF On/Off** to Off
5. Turn the signal generator's automatic leveling control (ALC) off: press **Amplitude > ALC Off On** to Off.
6. Monitor the RF output amplitude as measured by the power meter.
7. Press **Amplitude** and adjust the signal generator's RF output amplitude until the desired power is measured by the power meter.

Setting Power Search Mode

Power search mode executes a power search routine that temporarily activates the ALC, calibrates the power of the current RF output, and then disconnects the ALC circuitry. See the *E8257D/67D PSG Signal Generators Key Reference* for more information on the Power Search function.

Use the following steps to set the signal generator to manual fixed power search mode:

1. Preset the signal generator: press **Preset**.
2. Set the desired frequency: press **Frequency** and enter the desired frequency.
3. Set the desired amplitude: press **Amplitude** and enter the desired amplitude.
4. Turn the signal generator's automatic leveling control (ALC) off: press **Amplitude > ALC Off On** to Off.
5. Turn the RF on: set **RF On/Off** to On.
6. Press **Do Power Search**.

This executes the manual fixed power search routine, which is the default mode.

There are three power search modes: manual, automatic, and span.

When **Power Search** is set to **Manual**, pressing **Do Power Search** executes the power search calibration routine for the current RF frequency and amplitude. In this mode, if there is a change in RF frequency or amplitude, you will need to press **Do Power Search** again.

When **Power Search** is set to **Auto**, the calibration routine is executed whenever the frequency or amplitude of the RF output is changed.

When **Power Search** is set to **Span**, pressing **Do Power Search** executes the power search calibration routine over a selected range of frequencies at one time. The power search corrections are then stored and used whenever the signal generator is tuned within the selected range of frequencies.

No Modulation at the RF Output

Check the **MOD ON/OFF** annunciator on the display. If it reads **MOD OFF**, press **Mod On/Off** to toggle the modulation on.

Although you can set up and enable various modulations, the RF carrier is modulated only when you have also set **Mod On/Off** to On.

On the E8267D, for digital modulation, make sure that **I/Q Off On** is set to On.

Sweep Problems

Sweep Appears to be Stalled

The current status of the sweep is indicated as a shaded rectangle in the progress bar. You can observe the progress bar to determine if the sweep is progressing. If the sweep appears to have stalled, check the following:

- Have you turned on the sweep by pressing any of the following key sequences?
 - Sweep/List > Sweep > Freq
 - Sweep/List > Sweep > Ampl
 - Sweep/List > Sweep > Freq & Ampl
- Is the sweep in continuous mode? If the sweep is in single mode, be sure that you have pressed the **Single Sweep** softkey at least once since completion of the prior sweep. Try setting the mode to continuous to determine if the missing single sweep is blocking the sweep.
- Is the signal generator receiving the appropriate sweep trigger? Try setting the **Sweep Trigger** softkey to Free Run to determine if a missing sweep trigger is blocking the sweep.
- Is the signal generator receiving the appropriate point trigger? Try setting the **Point Trigger** softkey to Free Run to determine if a missing point trigger is blocking the sweep.
- Is the dwell time appropriate? Try setting the dwell time to one second to determine if the dwell time was set to a value which was too slow or too fast for you to see.
- Do you have at least two points in your step sweep or list sweep?

Cannot Turn Off Sweep Mode

Press **Sweep/List > Sweep > Off**.

In the sweep mode menu you can choose to set the sweep to various sweep types or to turn sweep off.

Incorrect List Sweep Dwell Time

If the signal generator does not dwell for the correct period of time at each sweep list point, follow these steps:

1. Press **Sweep/List > Configure List Sweep**.
This displays the sweep list values.
2. Check the sweep list dwell values for accuracy.
3. Edit the dwell values if they are incorrect.

NOTE The effective dwell time at the RF OUTPUT connector is the sum of the value set for the dwell plus processing time, switching time, and settling time. This additional time added to the dwell is generally a few milliseconds. The TTL/CMOS output available at the TRIG OUT connector, however, is asserted high only during the actual dwell time.

If the list dwell values are correct, continue to the next step.

4. Observe if the **Dwell Type List Step** softkey is set to **Step**.

When **Step** is selected, the signal generator will sweep the list points using the dwell time set for step sweep rather than the sweep list dwell values.

To view the step sweep dwell time, follow these steps:

- a. Press **Configure Step Sweep**.
- b. Observe the value set for the **Step Dwell** softkey.

List Sweep Information is Missing from a Recalled Register

List sweep information is not stored as part of the instrument state in an instrument state register. Only the current list sweep is available to the signal generator. List sweep data can be stored in the instrument catalog. For instructions, see [“Storing Files to the Memory Catalog” on page 52](#).

Data Storage Problems

Registers With Previously Stored Instrument States are Empty

The save/recall registers are backed-up by a battery when line power to the signal generator is not connected. The battery may need to be replaced.

To verify that the battery has failed:

1. Turn off line power to the signal generator.
2. Unplug the signal generator from line power.
3. Plug in the signal generator.
4. Turn on the signal generator.
5. Observe the display for error messages.

If either error message -311 or -700 is stored in the error message queue, the signal generator’s battery has failed.

6. Refer to the *E8257D/67D PSG Signal Generators Service Guide* for battery replacement instructions.

Saved Instrument State, but Register is Empty or Contains Wrong State

If you select a register number greater than 99, the signal generator automatically selects register 99 to save the instrument state.

If the register number you intended to use is empty or contains the wrong instrument state, recall register 99:

Press **Recall > 99 > Enter**.

The lost instrument state may be saved there.

Cannot Turn Off Help Mode

1. Press **Utility > Instrument Info/Help Mode**
2. Press **Help Mode Single Cont** until **Single** is highlighted.

The signal generator has two help modes; single and continuous.

When you press **Help** in single mode (the factory preset condition), help text is provided for the next key you press. Pressing another key will exit the help mode and activate the key's function.

When you press **Help** in continuous mode, help text is provided for the next key you press and that key's function is also activated (except for **Preset**). You will stay in help mode until you press **Help** again or change to single mode.

Signal Generator Locks Up

If the signal generator is locked up, check the following:

- Make sure that the signal generator is not in remote mode (in remote mode, the **R** annunciator appears on the display). To exit remote mode and unlock the front panel keypad, press **Local**.
- Make sure that the signal generator is not in local lockout condition. Local lockout prevents front panel operation. For more information on local lockout, refer to the *E8257D/67D PSG Signal Generators Programming Guide*.
- Check for a progress bar on the signal generator display, which indicates that an operation is in progress.
- Press **Preset**.
- Cycle power on the signal generator.

Fail-Safe Recovery Sequence

Use the fail-safe recovery sequence only if the previous suggestions do not resolve the problem.

CAUTION This process does reset the signal generator, but it also destroys the following types of data:

- all user files (instrument state and data files)
- DCFM/DCΦM calibration data
- persistent states

NOTE Do not attempt to perform any other front panel or remote operations during the fail-safe sequence.

To run the fail-safe sequence, follow these steps:

1. Hold down the **Preset** key while cycling power.
2. Continue to hold down the **Preset** key until the following message is displayed:

WARNING You are entering the diagnostics menu which can cause unpredictable instrument behavior. Are you sure you want to continue?

CAUTION Carefully read the entire message! It may list additional risks with this procedure.

3. Release the **Preset** key.
4. To continue with the sequence, press **Continue** (to abort with no lost files, press **Abort**).
5. When the sequence concludes, do the following:
 - a. Cycle power.
Cycling power restores all previously installed options. Because calibration files are restored from EEPROM, you should see several error messages.
 - b. Perform the DCFM/DCΦM calibration.
Refer to the DCFM/DCΦM Cal softkey description in the *E8257D/67D PSG Signal Generators Key Reference*.
 - c. Agilent Technologies is interested in the circumstances that made it necessary for you to initiate this procedure. Please contact us at the telephone number listed at <http://www.agilent.com/find/assist>. We would like to help you eliminate any repeat occurrences.

Error Messages

If an error condition occurs in the signal generator, it is reported to both the front panel display error queue and the SCPI (remote interface) error queue. These two queues are viewed and managed separately; for information on the SCPI error queue, refer to the *E58257D/67D PSG Signal Generators Programming Guide*.

NOTE When there is an unviewed message in the front panel error queue, the ERR annunciator appears on the signal generator's display.

Characteristic	Front Panel Display Error Queue
Capacity (#errors)	30
Overflow Handling	Circular (rotating). Drops oldest error as new error comes in.
Viewing Entries	Press: Utility > Error Info > View Next (or Previous) Error Page
Clearing the Queue	Press: Utility > Error Info > Clear Error Queue(s)
Unresolved Errors ^a	Re-reported after queue is cleared.
No Errors	When the queue is empty (every error in the queue has been read, or the queue is cleared), the following message appears in the queue: 0 No Error Message(s) in Queue

a. Errors that must be resolved. For example, unlock.

Error Message File

A complete list of error messages is provided in the file *errormessages.pdf*, on the CDROM supplied with your instrument.

In the error message list, an explanation is generally included with each error to further clarify its meaning. The error messages are listed numerically. In cases where there are multiple listings for the same error number, the messages are in alphabetical order.

Error Message Format

When accessing error messages through the front panel display error queue, the error numbers, messages and descriptions are displayed on an enumerated (“1 of N”) basis.

Error messages appear in the lower-left corner of the display as they occur.

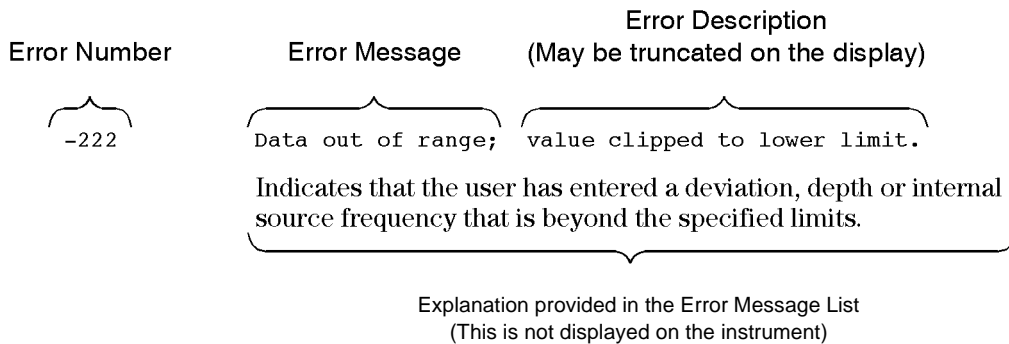

Error Message Types

Events do not generate more than one type of error. For example, an event that generates a query error will not generate a device-specific, execution, or command error.

Query Errors (-499 to -400) indicate that the instrument’s output queue control has detected a problem with the message exchange protocol described in IEEE 488.2, Chapter 6. Errors in this class set the query error bit (bit 2) in the event status register (IEEE 488.2, section 11.5.1). These errors correspond to message exchange protocol errors described in IEEE 488.2, 6.5. In this case:

- Either an attempt is being made to read data from the output queue when no output is either present or pending, or
- data in the output queue has been lost.

Device Specific Errors (-399 to -300, 201 to 703, and 800 to 810) indicate that a device operation did not properly complete, possibly due to an abnormal hardware or firmware condition. These codes are also used for self-test response errors. Errors in this class set the device-specific error bit (bit 3) in the event status register (IEEE 488.2, section 11.5.1).

The <error_message> string for a *positive* error is not defined by SCPI. A positive error indicates that the instrument detected an error within the GPIB system, within the instrument's firmware or hardware, during the transfer of block data, or during calibration.

Execution Errors (-299 to -200) indicate that an error has been detected by the instrument's execution control block. Errors in this class set the execution error bit (bit 4) in the event status register (IEEE 488.2, section 11.5.1). In this case:

- Either a <PROGRAM DATA> element following a header was evaluated by the device as outside of its legal input range or is otherwise inconsistent with the device's capabilities, or
- a valid program message could not be properly executed due to some device condition.

Execution errors are reported *after* rounding and expression evaluation operations are completed. Rounding a numeric data element, for example, is not reported as an execution error.

Command Errors (-199 to -100) indicate that the instrument's parser detected an IEEE 488.2 syntax error. Errors in this class set the command error bit (bit 5) in the event status register (IEEE 488.2, section 11.5.1). In this case:

- Either an IEEE 488.2 syntax error has been detected by the parser (a control-to-device message was received that is in violation of the IEEE 488.2 standard. Possible violations include a data element that violates device listening formats or whose type is unacceptable to the device.), or
- an unrecognized header was received. These include incorrect device-specific headers and incorrect or unimplemented IEEE 488.2 common commands.

Contacting Agilent Sales and Service Offices

Assistance with test and measurement needs, and information on finding a local Agilent office are available on the Internet at:

<http://www.agilent.com/find/assist>

You can also purchase E8257D/67D PSG accessories or documentation items on the Internet at:

<http://www.agilent.com/find/psg>

If you do not have access to the Internet, contact your field engineer.

NOTE In any correspondence or telephone conversation, refer to the signal generator by its model number and full serial number. With this information, the Agilent representative can determine whether your unit is still within its warranty period.

Returning a Signal Generator to Agilent Technologies

To return your signal generator to Agilent Technologies for servicing, follow these steps:

1. Gather as much information as possible regarding the signal generator's problem.
2. Call the phone number listed on the Internet (<http://www.agilent.com/find/assist>) that is specific to your geographic location. If you do not have access to the Internet, contact your field engineer.

After sharing information regarding the signal generator and its condition, you will receive information regarding where to ship your signal generator for repair.

3. Ship the signal generator in the original factory packaging materials, if available, or use similar packaging to properly protect the signal generator.

Symbols

ΦM, 15, 133

Numerics

003, option, 3
 004, option, 3
 005, option, 3
 007, option, 2, 5, 39
 015, option, 3
 10 MHz connectors, 24, 25
 128QAM I/Q modulation, creating, 150
 1410, application note, 179, 189
 1E1, option, 3
 1EA, option, 3
 1ED, option, 3
 1EH, option, 3
 1EM, option, 3
 2's complement description, 217, 229
 27 kHz pulse, 35
 601/602, option
 custom arb mode, 67, 137
 custom real-time mode, 159
 description, 3, 6
 multitone mode, 179
 symbol rates, 147
 two-tone mode, 189
 802.11b, 115
 8757 network analyzers, 45
 8757D Scalar Network Analyzer, 35, 39–48

A

AC power receptacle, 24
 ACP, 67, 142, 166
 active entry area (display), 14
 adding & editing (instrument state), 54
 adjustments, display, 11
 Agilent PSG web page, 1
 ALC
 annunciator, 15
 bandwidth selection, 115
 input connector, 10
 input connector (rear), 28
 limitations, amplitude, 117
 off mode, setting, 240

 with attenuator option, 118
 ALC hold
 description, 86
 saving setting, 86
 alpha adjustment (filter), 141
 alternate ramp sweep, 45
 AM, 15, 132
 amplifier, microwave, 231, 234
 amplitude
 display area, 17
 hardkey, 8
 LF output, 136
 modulation. *See* AM
 ramp sweep, 46
 reference & offset, 34
 analog modulation, 5, 131–136
 analog PSG
 optional features, 2
 standard features, 2
 annunciators, 15
 application notes
 1410, 179, 189
 obtaining, 1
 ARB
 AWGN, 195
 file catalogs, 51
 reference, setting, 157
 triggers, 98
 waveform clipping, 104–112
 waveform file headers, 68–78
 waveform scaling, 112–114
 See also custom arb waveform generator
 See also dual arbitrary waveform generator
 arb, 67
 ARMED annunciator, 15
 arrow hardkeys, 11
 ATTEN HOLD annunciator, 15
 attenuator, external leveling, 118
 AUTOGEN_WAVEFORM file, 79
 automatic leveling control. *See* ALC
 AUXILIARY I/O connector, 21
 AUXILIARY INTERFACE connector, 25
 AWGN
 ARB, 195
 dual ARB player, 82

Index

real-time, 195

B

bandwidth

ALC, selecting, 115

reference oscillator, adjusting, 130

baseband

clipping, 104–112

scaling, 112–114

baseband generator, 67

AWGN, 195

custom arb mode, 6, 137

custom real-time I/Q mode, 6, 159

dual arb mode, 6, 67

multitone mode, 6, 179

REF IN connector, 21

settings, 169, 170

two-tone mode, 6, 189

basic operation

digital, 67

standard, 29

BbT, adjusting, 141

binary files, 51

bit files, 51

bits per symbol, equation, 172

BURST GATE IN connector, 20

burst shapes, 165–169

burst signals, 115

C

carrier bandwidth, 82

carrier feedthrough, minimizing, 184, 192

carrier signal, modulating, 50

carrier to noise ratio, 82

CCDF curve, 110–111, 185

CDMA, 115

ceiling function, bits per symbol, 172

certificate, license key, 61

circular clipping, 110

clipping

CCDF curve, 110–111

circular, 107, 110

concepts, 104–110

procedure, 110, 111

rectangular, 107, 111

clock adjustment

phase and skew, 209

clock rate limits, logic type output, 198

clock source

setting, 220, 226

clock timing

parallel data, 204

parallel interleaved data, 207

phase and skew, 209

serial data, 209

clocking, frequency reference, 201

clocking, frequency reference diagrams, 203

Clocks Per Sample

parallel data, 204

parallel interleaved data, 207

COH connector, 24

comments, adding & editing (instrument state), 54

common frequency reference diagrams, 203

component test, 67

concepts

differential data encoding, 171

FIR filters, 140

waveform clipping, 104–110

waveform markers, 85

waveform scaling, 112–114

confidential data, 55

connections

common frequency reference, 203

connectors

external triggering, 101

external triggering source, 102

front panel, 7

rear panel, 18

continuous

list sweep, 39

step sweep, 37

triggering, 100

continuous wave

configuring, 32

description, 5

contrast adjustments (display), 11

correction array (user flatness)

configuration, 121

load from step array, 122

- viewing, [122](#)
- See also* user flatness correction
- couplers/splitters, using, [116](#)
- custom arb, [68](#)
- custom arb waveform generator, [6](#), [137–157](#)
- custom mode, [67](#)
- custom real-time I/Q baseband, [6](#), [159–178](#)
- CW mode
 - configuring, [32](#)
 - description, [5](#)
- D**
- DAC over-range errors, [112–114](#)
- DATA
 - input connector, [12](#)
 - input connector (rear), [28](#)
- data
 - clock, [170](#)
 - encoding, differential, [171–178](#)
 - fields, editing, [31](#)
 - files, [51](#)
 - framed, [99](#)
 - input methods, [56](#)
 - patterns
 - triggering, [98](#)
 - using, [160](#)
 - removal, [58](#)
 - sensitive, [55](#), [58](#)
 - storage
 - problems, [243](#)
 - security, [56](#)
 - See also* instrument state register
 - See also* memory catalog
 - unframed, [99](#)
- DATA CLOCK
 - input connector, [12](#)
 - input connector (rear), [28](#)
- data filtering, pre or post fir, [217](#), [229](#)
- data sheets, [1](#)
- data types, [212](#)
- DC detector, [35](#)
- DC offset, [133](#)
- declassification, [55](#)
- default FIR filter, restoring, [142](#)
- delay, external trigger signal, [100](#)
- Delete Item softkey, [31](#)
- Delete Row softkey, [31](#)
- description, adding & editing (instrument state), [54](#)
- detector
 - diode response, [117](#)
 - using, [116](#)
- device clock source selection, [220](#), [226](#)
- DHCP, [62](#)
- diagram
 - data types, [212](#)
- diagrams
 - clock timing, parallel data, [204](#)
 - clock timing, parallel interleaved data, [207](#)
 - clock timing, phase and skew, [209](#)
 - clock timing, serial data, [209](#)
 - common frequency reference, [203](#)
- differential data encoding, [171–178](#)
- DIG BUS annunciator, [15](#)
- Digital Bus connector, [21](#)
- digital modulation
 - annunciators, [17](#)
 - custom, [137–157](#), [159–178](#)
 - formats, [6](#)
 - multicarrier, [137](#), [139](#), [155](#)
 - multitone, [179–187](#)
 - two tone, [189–194](#)
- digital signal interface, [197](#)
- digital signal interface module, [197](#)
- diode detector response, [117](#)
- discrete steps, skew range, [209](#)
- display
 - blanking, [60](#)
 - contrast decrease, [11](#)
 - contrast increase, [11](#)
 - descriptions, [14](#)
 - overview, [14](#)
 - secure, [60](#)
- DMOD files, [51](#)
- documentation options, [4](#)
- downloading firmware, [4](#)
- dual arb, [67](#)
- dual ARB player, [6](#), [79–84](#)
- Dual ARB real-time noise, [82](#)
- dual arbitrary waveform generator, [6](#), [79–84](#)
- dwll time, [35](#)

Index

- E**
- E8257D
 - optional features, 2
 - standard features, 2
 - E8267D
 - optional features, 3
 - standard features, 3
 - Edit Item softkey, 31
 - Erase All, 58, 59, 60
 - erasing memory, 55, 58, 59, 60
 - ERR annunciator, 15, 245
 - error messages
 - DAC over-range, 112–114
 - display, 17
 - message format, 246
 - overview, 245
 - queue, 245
 - types, 246
 - EVENT connectors, 20
 - EVM, 142, 166
 - EXT
 - annunciators, 15
 - INPUT connectors, 9
 - input connectors, 9
 - input connectors (rear), 27
 - extend frequency, 49
 - extend frequency range, 49
 - external
 - data clock, setting, 170
 - detector, diode response, 117
 - external clock source selection, 220, 226
 - external FM, 133
 - external I/Q modulation, 155
 - external source module, 230
 - external trigger
 - connection, 101
 - gated, setting, 101
 - single, setting, 155
 - source connector, 102
- F**
- fail-safe recovery sequence, 244
 - failures. *See* troubleshooting
 - fall delay, burst shape, 166
 - fall time, burst shape, 166
 - FAQ, 1
 - features, signal generator, 1
 - feedthrough, carrier, minimizing, 192
 - file headers (ARB waveform), 68–78
 - file store
 - files, 53
 - catalogs, 51
 - using, 52
 - waveform segments, 80–84
 - waveform sequences, 81–83
 - See also* instrument state register
 - See also* memory catalog
 - filtered & unfiltered samples, 217, 229
 - filters
 - interpolation, 112–113
 - using, 140–147
 - FIR, 51, 140
 - firmware
 - options, 4
 - upgrades
 - obtaining, 4
 - using GPIB, 4
 - using LAN, 4
 - using RS-232, 4
 - flatness correction. *See* user flatness correction
 - FM, 15, 132
 - FM/ Φ M hardkey, 9
 - formula, skew discrete steps, 209
 - framed data, 99
 - free run trigger response, 100
 - frequency
 - display area, 15
 - hardkey, 8
 - modulation. *See* FM
 - offset, 33
 - ramp sweep, 39
 - ranges, 1
 - reference, 33
 - RF output, setting, 32
 - frequency extension, 49
 - frequency output limits, clock rates & logic levels, 198
 - frequency range, 49
 - frequency reference

- common, 201
- hookup diagrams, 203
- front panel
 - description, 7–14
 - disabling keys, 60
- FSK
 - files, 51
 - modulation, 149, 153, 154
- G**
- GATE/PULSE/TRIGGER
 - input connector, 11
 - input connector (rear), 27
- gated, 134
- gated triggering, 99, 101
- Gaussian filter, selecting, 141
- Goto Row softkey, 31
- GPIB, 24, 124
- H**
- hardkeys, 7–12
- hardware, configuring, 155, 169
- Help hardkey, 9
- help mode troubleshooting, 244
- Hold hardkey, 11
- I**
- I input connector, 13
- I input connector (rear), 28
- I OUT connector, 23
- I/O connector, auxiliary, 21
- I/Q
 - 4QAM state map, 172
 - annunciator, 15
 - files, 51
 - input connectors, 13
 - modulation, 153, 176
 - scaling, adjusting, 170
- I/Q waveform
 - clipping, 104–112
 - scaling, 112–114
- I-bar OUT connector, 23
- IMD. *See* intermodulation distortion
- Incr Set hardkey, 11
- information
 - additional PSG, 1
 - protecting sensitive, 55
- Insert Item softkey, 31
- Insert Row softkey, 31
- installing firmware, 4
- instrument state register
 - comments, adding and editing, 54
 - troubleshooting, 243
 - using, 53
 - See also* memory catalog
- instrument states, 45
- int gated, 134
- interface connectors
 - AUXILIARY INTERFACE, 25
 - GPIB, 24
 - LAN, 26
 - RS-232, 25
- interface, remote, 124
- intermodulation distortion
 - how to minimize, 106
 - testing non-linear devices, 179, 189
- internal clock source selection, 220, 226
- interpolation filter, 112–113
- IQ
 - clock rates, 200
 - modulation, 155
- IQ modulation, 155
- K**
- key, license, 61
- keypad, numeric, 10
- keys
 - disabling, 60
 - front panel, 7–12
- knob, front panel, 8
- L**
- L (listener mode) annunciator, 16
- lan configuration, 62
- LAN connector, 26
- LEDs, 12
- leveling
 - ALC, 10, 240

Index

- external, [116–119](#)
 - internal, [115](#)
 - mm-wave source module, using, [230](#)
 - LF OUT connector, [27](#)
 - LF output, [10](#), [135–136](#)
 - license key, [61](#)
 - limits, clock & sample rates, logic outputs, [198](#)
 - line power LED, [12](#)
 - list
 - error messages, [246](#)
 - files, [51](#)
 - mode values table editor, [30](#)
 - sweep, [37](#), [242](#)
 - listener mode annunciator, [16](#)
 - Load/Store softkey, [31](#)
 - Local hardkey, [11](#)
 - logic type
 - output levels, [198](#)
 - selecting, [214](#)
 - low frequency output. *See* LF output
- ## M
- magnitude error simulation, [153](#)
 - manual freq softkey, [45](#)
 - manual sweep, [45](#)
 - markers
 - output, [26](#)
 - ramp sweep, [42](#)
 - waveform, [84–98](#)
 - master/slave setup, [46](#)
 - MDMOD files, [51](#)
 - media storage, [56](#)
 - memory, [79](#)
 - base instrument, [56](#)
 - baseband generator, [56](#)
 - catalog, [51](#), [243](#)
 - See also* instrument state register
 - erasing, [55](#), [58](#)
 - hard disk, [56](#)
 - overwriting, [59](#)
 - persistence, [56](#)
 - physical location, [56](#)
 - sanitizing, [59](#)
 - secure mode, [59](#)
 - size, [56](#)
 - types, [56](#)
 - waveform, [56](#)
 - writing to, [56](#)
 - menus
 - marker, [88](#)
 - marker polarity, [98](#)
 - trigger, [100](#)
 - MENUS hardkeys, [9](#)
 - microwave amplifier, [231](#), [234](#)
 - Millimeter, [230](#)
 - millimeter-wave source module, [230](#)
 - mixer, signal loss while using, [238](#)
 - mm-source, [49](#)
 - mm-wave source module
 - extending frequency range with, [230](#)
 - leveling with, [119](#)
 - user flatness correction array, creating, [124–130](#)
 - mod on/off, [10](#), [16](#)
 - models, signal generator, [1](#)
 - modes of operation, [5](#)
 - modes, triggering, [99](#)
 - modulation
 - amplitude. *See* AM
 - analog, [5](#), [131–136](#)
 - analog waveforms, [131](#)
 - annunciators, [15–17](#)
 - applying, [49](#)
 - digital, [6](#)
 - file catalogs, [51](#)
 - frequency. *See* FM
 - multicarrier, [137](#), [139](#), [155](#)
 - on/off hardkey, [10](#)
 - phase. *See* Φ M
 - predefined setups, [137](#), [159](#)
 - pulse, [5](#), [134](#)
 - types, [149](#)
 - user-defined, [138](#), [176](#)
 - See also* digital modulation
 - module user interface location, [213](#), [222](#)
 - MSK modulation, [149](#)
 - MTONE files, [51](#)
 - multicarrier waveform, [137](#), [139](#), [155](#)
 - multitone, [67](#)
 - multitone mode, [6](#)
 - multitone waveform generator, [179–187](#)

N

N5102A, 197

- baseband data, 213
- clock rates, 197
- clock settings, 218, 225
- clock source
 - description, 201
- clock timing, 197, 204
- common frequency reference, 201
- connections to clock and device, 210
- data parameters, setting, 215, 228
- data types, 212
- digital data, 230
- frequency reference connector, 202
- generating data, 222
- input direction, 223
- input mode, 212, 222
- interleaving clock timing, 207
- logic type, port configuration, 224
- logic types, 214
- output direction, 215
- output mode, 212, 213
- phase and skew clock timing, 209
- serial clock timing, 209
- user interface, 213
- user interface module, 222

N5102A digital signal interface module, 197

negation description, 218, 230

noise, 82, 195

noise bandwidth factor, 82

non-linear devices, testing, 179, 189

non-volatile memory, 79

numeric format selection, 217, 229

numeric keypad, 10

NVMKR files, 51

nvwfm, 79

NVWFM files, 51

Nyquist filters, 141, 142

O

OFDM, 115

offset, 33, 34, 133

offset binary use, 217, 229

on/off switch, 12

operation

- basics, 29
- digital basics, 67
- modes of, 5

option 015, 155

options

- 003, 3
- 004, 3
- 005, 3
- 007, 2, 5, 39
- 015, 3
- 1E1, 3
- 1EA, 3
- 1ED, 3
- 1EH, 3
- 1EM, 3
- 601/602
 - basic digital operation, 67
 - custom arb mode, 137
 - custom real-time mode, 159
 - description, 3, 6
 - multitone mode, 179
 - two-tone mode, 189
 - using symbol rates, 147

additional information, 4

enabling, 61

UNR/UNX, 2, 130

UNT, 2, 5, 131–134, 135

UNU, 2, 5, 131, 134

UNW, 3, 5, 131, 134

oscillator, reference, adjusting BW, 130

output levels, logic types, 198

output power, troubleshooting, 238

output. *See* LF output *and* RF output

OVEN COLD annunciator, 16

over-range errors, 112–114

overwriting memory, 59

P

Page Down softkey, 31

Page Up softkey, 31

parallel

- clock rates, 200
- data clock timing, 204
- interleaved data clock timing, 207

Index

- sample rates, 200
- PATTERN TRIG IN connector, 20
- peak to average power
 - CCDF curve, 110, 185
 - high ratios, 106
 - multitone characteristics, 185
 - reducing, 107
- performance, optimizing, 115–130
- peripheral devices, 197
 - digital signal interface module, 197
 - millimeter wave source module, 197
- phase
 - error simulation, 153
 - modulation. *See* Φ M
 - polarity, 171
- phase clock timing, 209
- player, dual ARB, 79–84
- polarity
 - marker setting, saving, 69
 - markers, 98
 - trigger, external, 101
- port configuration, selecting, 214
- power
 - meter, 120, 240
 - output, troubleshooting, 238
 - peaks, 104–110
 - receptacle, AC, 24
 - search mode, 241
 - supply troubleshooting, 238
 - switch, 12
- PRAM, 67
- predefined filters, 140
- predefined modulation setups, 137, 159
- pre-fir samples selection, 217, 229
- Preset hardkey, 12
- private data, 55
- problems. *See* troubleshooting
- product information, 1
- proprietary data, 55
- protecting data, 55
- PSG
 - additional information, 1
 - firmware, 4
 - modes of operation, 5
 - options, 4

- web page, 1
- PSK modulation, 149
- pulse, 115
 - annunciator, 16
 - input, 11
 - input (rear), 27
 - modulation, 134
- pulse modulation, 5, 35
- pulse source, 35, 134
- PULSE SYNC OUT, 27
- PULSE VIDEO OUT, 27
- pulse, marker, viewing, 95
- PULSE/TRIG GATE INPUT, 27

Q

- Q input connector, 13
- Q input connector (rear), 28
- Q OUT connector, 23
- QAM modulation, 149, 172
- Q-bar OUT connector, 24
- QPSK I/Q modulation, creating, 151
- queue, error, 245

R

- R (remote) annunciator, 16
- ramp sweep, 39–48
- real time, 67
- real-time AWGN, 195
- real-time I/Q, 159–178
- real-time mode, 6, 68
- real-time noise, 82
- real-time triggers, 98
- rear panel description, 18
- Recall hardkey, 8
- recall state, 45
- recall states, 53
- receiver test, 67
- recovery sequence, fail-safe, 244
- rectangular clipping, 111
- reference
 - amplitude, setting, 34
 - frequency, setting, 33
 - oscillator bandwidth, adjusting, 130
- registers, 53, 54

- remote operation, [9](#), [124](#)
- remote operation annunciator, [16](#)
- reset & run trigger response, [100](#)
- response, triggering mode, [99](#)
- restricted data, [55](#)
- Return hardkey, [11](#)
- returning a signal generator, [247](#)
- RF blanking, [237](#)
 - marker function, [96](#)
 - settings, saving, [86](#)
- RF output
 - annunciator, [16](#)
 - configuring, [32](#)
 - connector, [10](#)
 - connector (rear), [27](#)
 - leveling, external, [116–119](#)
 - mm-wave source module, using, [230](#)
 - On/Off hardkey, [10](#)
 - sweeping, [34](#)
 - troubleshooting, [237](#)
 - user flatness correction, [119–130](#)
- rise delay, burst shape, [166](#)
- rise time, burst shape, [166](#)
- root Nyquist filters, [141](#), [142](#)
- routing, marker
 - ALC hold, [86](#)
 - RF blanking, [96](#)
 - saving settings, [86](#)
 - settings, saving, [69](#)
- RS-232 connector, [25](#)
- runtime scaling, [114](#)
- S**
- S (service request) annunciator, [16](#)
- sample
 - rates, [197](#)
 - rates, parallel/parallel intrlvd port configuration, [200](#)
 - rates, serial port configuration, [199](#)
 - type selection, [217](#), [229](#)
- samples
 - baseband, [112–113](#)
 - interpolated, [112–113](#)
- sanitizing memory, [59](#)
- save and recall, [45](#)
- save and recall states, [53](#)
- save files
- Save hardkey, [8](#)
- scalar network analyzer, [35](#), [39–48](#)
- scalar pulse, [35](#)
- scaling
 - concepts, [112–114](#)
 - procedure, [114](#)
 - runtime, [114](#)
 - waveform data, [114](#)
- SCPI, [62](#)
- SCPI commands, [9](#)
- secure display, [60](#)
- secure mode, [59](#)
- security functions, [55](#), [59](#)
- security level, [59](#)
- segment advance triggering, [100](#), [103](#)
- sensitive data, [55](#)
- Seq files, [51](#)
- sequences
 - building and storing, [81](#)
 - deleting, [54](#)
 - editing, [82](#)
 - instrument state register, [53](#)
 - marker control, [93](#)
 - playing, [82](#)
 - triggering, [98](#)
- serial
 - clock and sample rates, [199](#)
 - clock timing, [209](#)
- service request annunciator, [16](#)
- service, Agilent sales and service offices, [247](#)
- shape files, [51](#)
- signal generator
 - features, [1](#)
 - firmware, [4](#)
 - models, [1](#)
 - modes, [5](#)
 - options, [4](#)
 - overview, [1](#)
- signal loss, troubleshooting, [237](#)
- Signal Studio software, [179](#), [189](#)
- single step sweep, [36](#)
- single trigger mode, [99](#)
- single trigger, setting, [155](#)

Index

- skew
 - clock timing, 209
 - range, 209
- SMI connector, 24
- softkeys, 8, 17, 31
- software
 - available for PSG, 1
 - options, 4
- source module, 230
- SOURCE SETTLED OUTPUT connector, 27
- source, external trigger, 100
- spectral regrowth, 106
- spectrum analyzer, troubleshooting signal loss, 240
- square pulse, 35
- standby LED, 12
- state files, 51
- state registers, 45
- step array (user flatness), 120
 - See also* user flatness correction
- step attenuator, external leveling, 118
- step sweep, 35–37
- STOP SWEEP connector, 26
- storage, troubleshooting, 243
- sweep
 - 27 kHz pulse, 35
 - 8757D Scalar Network Analyzer, 35
 - annunciator, 16
 - DC detector, 35
 - list, 37
 - mode, 5
 - output, 26
 - ramp, 39–48
 - RF output, 34
 - scalar network analyzer, 35
 - scalar pulse, 35
 - step, 35
 - trigger, 38
 - troubleshooting, 242
- sweep progress bar, 34
- Sweep/List hardkey, 9
- switch, power, 12
- symbol rates, 147
- SYMBOL SYNC
 - input connector, 12
 - input connector (rear), 28
- SYNC OUT connector, 10
- SYNC OUT connector (rear), 27
- T
- T (talker mode) annunciator, 16
- table editor, using, 30–31
- talker mode annunciator, 16
- TCP/IP, 62
- technical support, 1
- text display area, 17
- trigger
 - hardkey, 8
 - inputs
 - GATE/PULSE/TRIGGER, 11
 - GATE/PULSE/TRIGGER (rear), 27
 - PATTERN TRIG IN, 20
 - TRIGGER IN, 27
 - output, 26
 - setting, 38
- trigger & run, 100
- trigger in, 134
- trigger polarity, 134
- triggers, 98–104, 155
- troubleshooting, 237–247
- two tone, 6, 67, 189–194
- U
- unfiltered & filtered samples, 217, 229
- unframed data, 99
- UNLEVEL annunciator, 17
- UNLOCK annunciator, 17
- UNR/UNX, option, 2, 130
- UNT, option, 2, 5, 131–134, 135
- UNU, option, 2, 5, 131, 134
- UNW, option, 3, 5, 131, 134
- upgrading firmware, 4
- user flatness, 51, 119–130
- user interface location, module, 213, 222
- user-defined
 - burst shape curves, 166
 - data patterns, 161
 - files, 51
 - filters, 142, 144
 - modulation type

custom arb, 138
real-time I/Q, 150, 176

V

vector PSG
 optional features, 3
 standard features, 3
VIDEO OUT connector, 11
VIDEO OUT connector (rear), 27
volatile memory, 79

W

warranted logic output clock rates, 198
waveform memory, 56
waveforms
 analog modulation, 131
 ARB file headers, 68–78
 CCDF curve, 110–111
 clipping, 104–112
 custom, 137–157
 custom real-time I/Q baseband, 159–178
 DAC over-range errors, 112–114
 file catalogs, 51
 interpolation, 112–113
 markers, 84
 multicarrier, 137, 139, 155
 multitone, 179–187
 player, dual ARB, 79–84
 samples, 112–113
 scaling, 112–114
 segments, 80–84
 sequences, 81–83, 93
 statistics, 110–111
 triggering, 98
 two-tone, 189–194
 utilities, 110–111
web server, 62
website, 1
wfm1, 79
WFM1 files, 51
WIDEBAND I INPUT connector, 22
wideband IQ, 155
WIDEBAND Q INPUT connector, 23

Z

Z-AXIS BLANK/MKRS connector, 26

